

# Switch Mode Power Rectifier

## MBR3045WTG

These state-of-the-art devices use the Schottky Barrier principle with a platinum barrier metal.

### Features

- Dual Diode Construction; Terminals 1 and 3 may be Connected for Parallel Operation at Full Rating
- Guardring for Stress Protection
- Low Forward Voltage
- 175°C Operating Junction Temperature
- Popular TO-247 Package
- These Devices are Pb-Free, Halogen Free/BFR Free and are RoHS Compliant\*

### Mechanical Characteristics

- Case: Epoxy, Molded
- Weight: 4.3 Grams (Approximately)
- Finish: All External Surfaces Corrosion Resistant and Terminal Leads are Readily Solderable
- Lead Temperature for Soldering Purposes: 260°C Max. for 10 Seconds

### MAXIMUM RATINGS

Rating	Symbol	Max	Unit
Peak Repetitive Reverse Voltage	$V_{RRM}$	45	V
Working Peak Reverse Voltage	$V_{RWM}$		
DC Blocking Voltage	$V_R$		
Average Rectified Forward Current (Rated $V_R$ , $T_C = 105^\circ\text{C}$ )	$I_{F(AV)}$	30 15	A Per Device Per Diode
Peak Repetitive Forward Current, (Rated $V_R$ , Square Wave, 20 kHz)	$I_{FRM}$	30	A Per Diode
Non-Repetitive Peak Surge Current (Surge Applied at Rated Load Conditions Halfwave, Single Phase, 60 Hz)	$I_{FSM}$	200	A
Peak Repetitive Reverse Current (2.0 $\mu\text{s}$ , 1.0 kHz) Per Diode (See Figure 6)	$I_{RRM}$	2.0	A
Storage Temperature Range	$T_{stg}$	-65 to +175	°C
Operating Junction Temperature (Note 1)	$T_J$	-65 to +175	°C
Peak Surge Junction Temperature (Forward Current Applied)	$T_{J(pk)}$	175	°C
Voltage Rate of Change (Rated $V_R$ )	$dv/dt$	10,000	V/ $\mu\text{s}$

Stresses exceeding those listed in the Maximum Ratings table may damage the device. If any of these limits are exceeded, device functionality should not be assumed, damage may occur and reliability may be affected.

1. The heat generated must be less than the thermal conductivity from Junction-to-Ambient:  $dP_D/dT_J < 1/R_{\theta JA}$ .

\*For additional information on our Pb-Free strategy and soldering details, please download the ON Semiconductor Soldering and Mounting Techniques Reference Manual, SOLDERRM/D.



ON Semiconductor®

[www.onsemi.com](http://www.onsemi.com)

**SCHOTTKY BARRIER  
RECTIFIER  
30 AMPERES, 45 VOLTS**

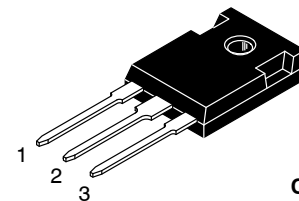
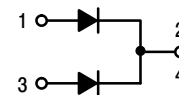

TO-247  
CASE 340AL

### MARKING DIAGRAM

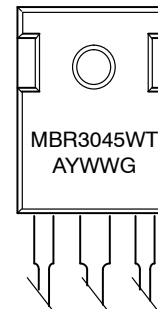

A = Assembly Location  
Y = Year  
WW = Work Week  
G = Pb-Free Package

### ORDERING INFORMATION

Device	Package	Shipping
MBR3045WTG	TO-247 (Pb-Free)	30 Units/Rail

# MBR3045WTG

## THERMAL CHARACTERISTICS (Per Diode)

Rating	Symbol	Max	Unit
Thermal Resistance, Junction-to-Case	$R_{\theta JC}$	1.4	$^{\circ}\text{C}/\text{W}$
Junction-to-Ambient	$R_{\theta JA}$	40	$^{\circ}\text{C}/\text{W}$

## ELECTRICAL CHARACTERISTICS (Per Diode)

Instantaneous Forward Voltage (Note 2) ( $i_F = 20$ Amps, $T_C = 125^{\circ}\text{C}$ ) ( $i_F = 30$ Amps, $T_C = 125^{\circ}\text{C}$ ) ( $i_F = 30$ Amps, $T_C = 25^{\circ}\text{C}$ )	$v_F$	0.62 0.72 0.76	V
Instantaneous Reverse Current (Note 2) (Rated dc Voltage, $T_C = 125^{\circ}\text{C}$ ) (Rated dc Voltage, $T_C = 25^{\circ}\text{C}$ )	$i_R$	100 1.0	mA

Product parametric performance is indicated in the Electrical Characteristics for the listed test conditions, unless otherwise noted. Product performance may not be indicated by the Electrical Characteristics if operated under different conditions.

2. Pulse Test: Pulse Width = 300  $\mu\text{s}$ , Duty Cycle  $\leq 2.0\%$ .

## TYPICAL CHARACTERISTICS

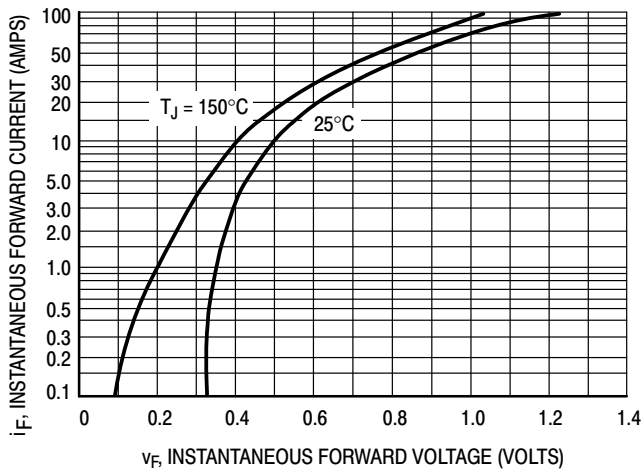

Figure 1. Typical Forward Voltage

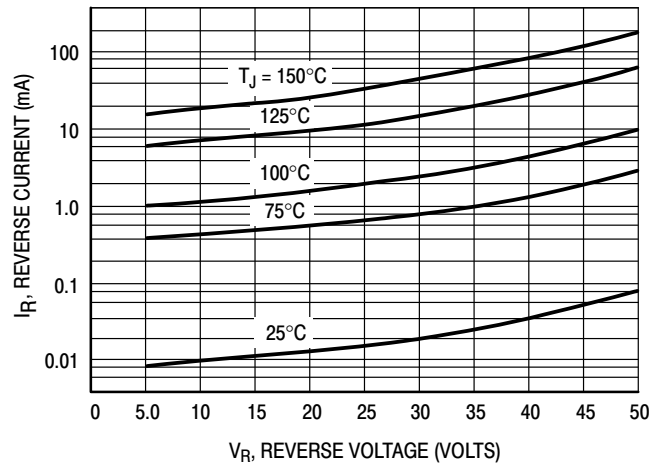

Figure 2. Typical Reverse Current

# MBR3045WTG

## TYPICAL CHARACTERISTICS

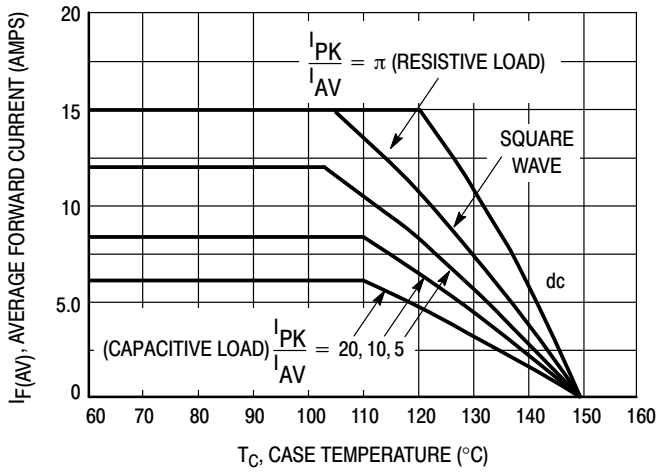

Figure 3. Current Derating (Per Leg)

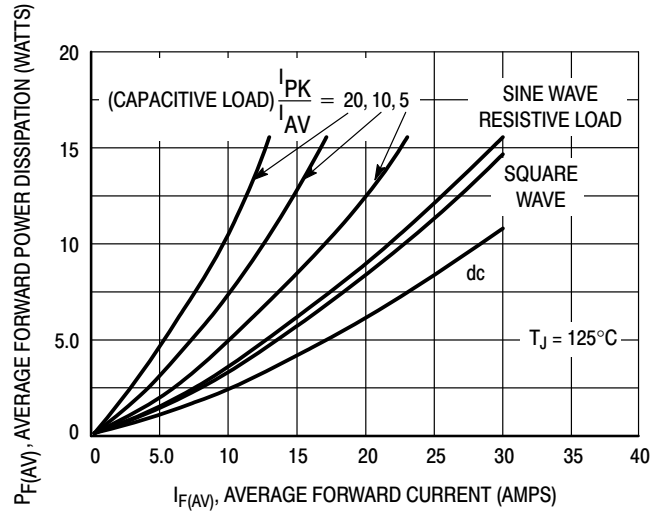

Figure 4. Forward Power Dissipation (Per Leg)

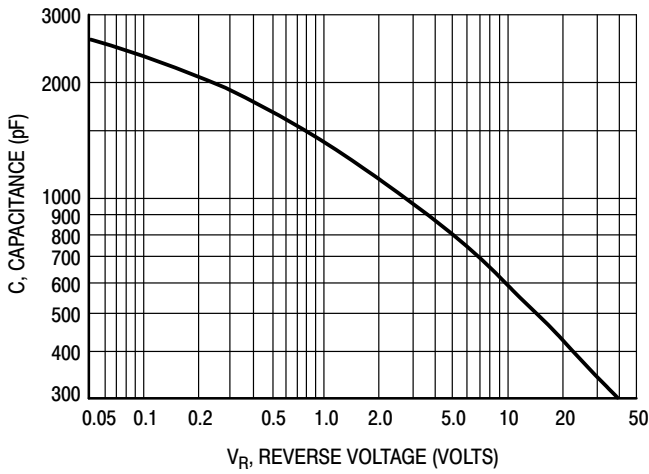

Figure 5. Capacitance

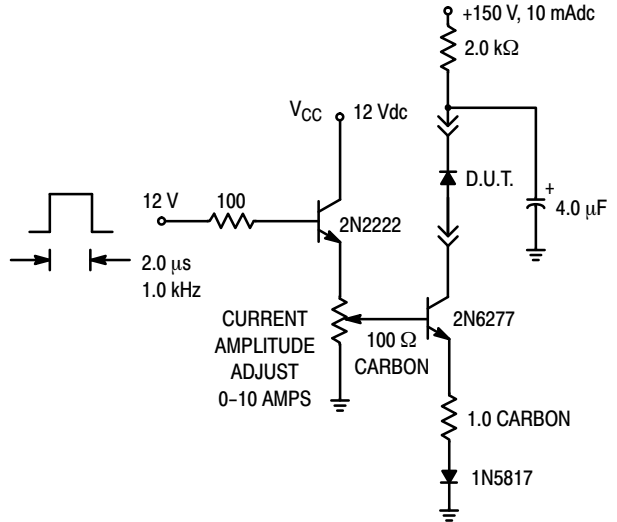

Figure 6. Test Circuit for Repetitive Reverse Current

# MECHANICAL CASE OUTLINE

## PACKAGE DIMENSIONS

ON Semiconductor®



TO-247  
CASE 340AL  
ISSUE D

DATE 17 MAR 2017

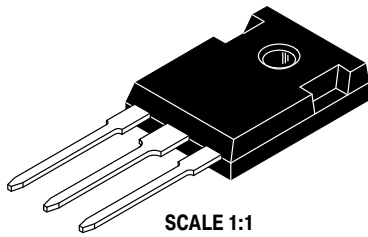

SCALE 1:1

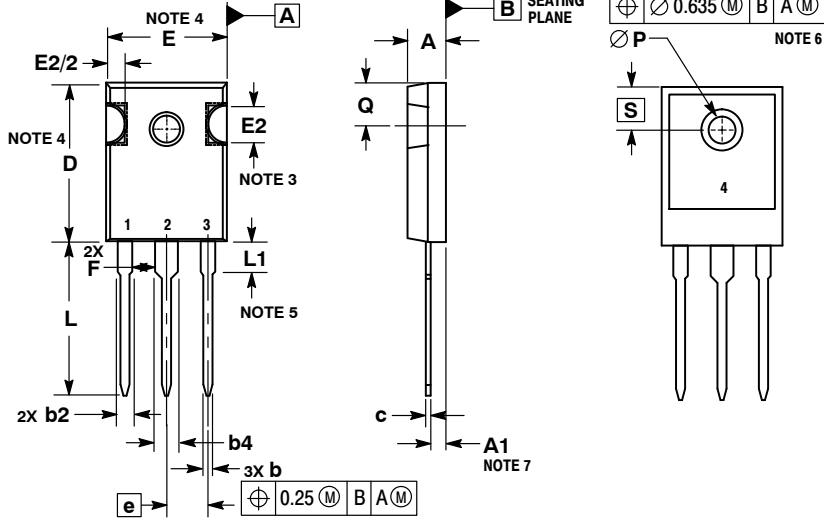

NOTES:

1. DIMENSIONING AND TOLERANCING PER ASME Y14.5M, 1994.
2. CONTROLLING DIMENSION: MILLIMETERS.
3. SLOT REQUIRED, NOTCH MAY BE ROUNDED.
4. DIMENSIONS D AND E DO NOT INCLUDE MOLD FLASH. MOLD FLASH SHALL NOT EXCEED 0.13 PER SIDE. THESE DIMENSIONS ARE MEASURED AT THE OUTERMOST EXTREME OF THE PLASTIC BODY.
5. LEAD FINISH IS UNCONTROLLED IN THE REGION DEFINED BY L1.
6.  $\varnothing P$  SHALL HAVE A MAXIMUM DRAFT ANGLE OF 1.5° TO THE TOP OF THE PART WITH A MAXIMUM DIAMETER OF 3.91.
7. DIMENSION A1 TO BE MEASURED IN THE REGION DEFINED BY L1.

MILLIMETERS		
DIM	MIN	MAX
A	4.70	5.30
A1	2.20	2.60
b	1.07	1.33
b2	1.65	2.35
b4	2.60	3.40
c	0.45	0.68
D	20.80	21.34
E	15.50	16.25
E2	4.32	5.49
e	5.45 BSC	
F	2.655	---
L	19.80	20.80
L1	3.81	4.32
P	3.55	3.65
Q	5.40	6.20
S	6.15 BSC	

### GENERIC MARKING DIAGRAM\*

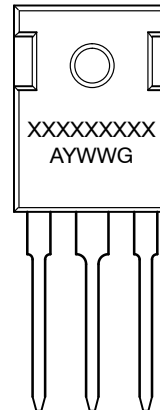

- XXXXX = Specific Device Code
- A = Assembly Location
- Y = Year
- WW = Work Week
- G = Pb-Free Package

\*This information is generic. Please refer to device data sheet for actual part marking.  
Pb-Free indicator, "G" or microdot "▪", may or may not be present.

DOCUMENT NUMBER:	98AON16119F	Electronic versions are uncontrolled except when accessed directly from the Document Repository. Printed versions are uncontrolled except when stamped "CONTROLLED COPY" in red.
DESCRIPTION:	TO-247	PAGE 1 OF 1

ON Semiconductor and are trademarks of Semiconductor Components Industries, LLC dba ON Semiconductor or its subsidiaries in the United States and/or other countries. ON Semiconductor reserves the right to make changes without further notice to any products herein. ON Semiconductor makes no warranty, representation or guarantee regarding the suitability of its products for any particular purpose, nor does ON Semiconductor assume any liability arising out of the application or use of any product or circuit, and specifically disclaims any and all liability, including without limitation special, consequential or incidental damages. ON Semiconductor does not convey any license under its patent rights nor the rights of others.

**onsemi**, **Onsemi**, and other names, marks, and brands are registered and/or common law trademarks of Semiconductor Components Industries, LLC dba "**onsemi**" or its affiliates and/or subsidiaries in the United States and/or other countries. **onsemi** owns the rights to a number of patents, trademarks, copyrights, trade secrets, and other intellectual property. A listing of **onsemi**'s product/patent coverage may be accessed at [www.onsemi.com/site/pdf/Patent-Marking.pdf](http://www.onsemi.com/site/pdf/Patent-Marking.pdf). **onsemi** reserves the right to make changes at any time to any products or information herein, without notice. The information herein is provided "as-is" and **onsemi** makes no warranty, representation or guarantee regarding the accuracy of the information, product features, availability, functionality, or suitability of its products for any particular purpose, nor does **onsemi** assume any liability arising out of the application or use of any product or circuit, and specifically disclaims any and all liability, including without limitation special, consequential or incidental damages. Buyer is responsible for its products and applications using **onsemi** products, including compliance with all laws, regulations and safety requirements or standards, regardless of any support or applications information provided by **onsemi**. "Typical" parameters which may be provided in **onsemi** data sheets and/or specifications can and do vary in different applications and actual performance may vary over time. All operating parameters, including "Typicals" must be validated for each customer application by customer's technical experts. **onsemi** does not convey any license under any of its intellectual property rights nor the rights of others. **onsemi** products are not designed, intended, or authorized for use as a critical component in life support systems or any FDA Class 3 medical devices or medical devices with a same or similar classification in a foreign jurisdiction or any devices intended for implantation in the human body. Should Buyer purchase or use **onsemi** products for any such unintended or unauthorized application, Buyer shall indemnify and hold **onsemi** and its officers, employees, subsidiaries, affiliates, and distributors harmless against all claims, costs, damages, and expenses, and reasonable attorney fees arising out of, directly or indirectly, any claim of personal injury or death associated with such unintended or unauthorized use, even if such claim alleges that **onsemi** was negligent regarding the design or manufacture of the part. **onsemi** is an Equal Opportunity/Affirmative Action Employer. This literature is subject to all applicable copyright laws and is not for resale in any manner.

## PUBLICATION ORDERING INFORMATION

### LITERATURE FULFILLMENT:

Email Requests to: [orderlit@onsemi.com](mailto:orderlit@onsemi.com)

**onsemi Website:** [www.onsemi.com](http://www.onsemi.com)

### TECHNICAL SUPPORT

**North American Technical Support:**

Voice Mail: 1 800-282-9855 Toll Free USA/Canada

Phone: 011 421 33 790 2910

**Europe, Middle East and Africa Technical Support:**

Phone: 00421 33 790 2910

For additional information, please contact your local Sales Representative