

## Solid-Electrolyte TANTALEX™ Capacitors, Hermetically-Sealed, Axial-Lead

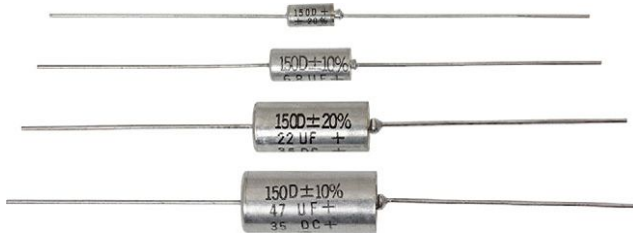

### PERFORMANCE CHARACTERISTICS

- Operating Temperature:** -55 °C to +125 °C  
(above 85 °C, voltage derating is required)
- Capacitance Tolerance:** at 120 Hz, +25 °C  
± 20 %, ± 10 % standard. ± 5 % available as special
- Dissipation Factor:** at 120 Hz, +25 °C
- DC Leakage Current (DCL Max.):**  
**at +25 °C:** leakage current shall not exceed the values listed in the Standard Ratings table  
**at +85 °C:** leakage current shall not exceed 10 times the values listed in the Standard Ratings table  
**at +125 °C:** leakage shall not exceed 15 times the values listed in the Standard Ratings table
- Life Test:** capacitors shall withstand rated DC voltage applied at +85 °C for 2000 h or derated DC voltage applied at +125 °C for 1000 h
- Following the life test:
1. DCL shall not exceed 125 % of the initial requirement
  2. Dissipation factor shall meet the initial requirement
  3. Change in capacitance shall not exceed ± 5 %

### FEATURES

- Terminations: tin / lead (SnPb), 100 % tin (RoHS-compliant)
- These high performance, hermetically-sealed TANTALEX capacitors have set the standard for solid-electrolyte tantalum capacitors for more than three decades
- High capacitance, low DCL, low dissipation factor and exceptional operating stability
- Performance and reliability have been proven in commercial, industrial and military applications
- Available in four case codes and capacitors and are supplied with plastic-film insulation
- Terminals are solid, tinned nickel wire leads
- The military equivalent of the 150D is the M39003/01 (style CSR13) which is qualified to MIL-PRF-39003/1
- Material categorization: for definitions of compliance please see [www.vishay.com/doc?99912](http://www.vishay.com/doc?99912)

### Note

\* This datasheet provides information about parts that are RoHS-compliant and / or parts that are non RoHS-compliant. For example, parts with lead (Pb) terminations are not RoHS-compliant. Please see the information / tables in this datasheet for details



**RoHS\***  
Available

HALOGEN

**FREE**

**GREEN**

(5-2008)

Available

| ORDERING INFORMATION |  |   |  |                                  |                                       |  |   |
|----------------------|--|---|--|----------------------------------|---------------------------------------|--|---|
| 150D                 | 224  | X0  | 006  | A                                | 2                                     | T  | E3  |
| MODEL                | CAPACITANCE  | CAPACITANCE TOLERANCE   | DC VOLTAGE RATING AT 85 °C   | CASE CODE                        | STYLE NUMBER                          | PACKAGING                                      | RoHS-COMPLIANT  |
|                      | This is expressed in picofarads. The first two digits are the significant figures. The third is the number of zeros to follow. | X0 = ± 20 %<br>X9 = ± 10 %<br>X5 = ± 5 % *<br>* Special order | This is expressed in volts. To complete the three-digit block, zeros precede the voltage rating. | See Ratings and Case Codes table | 0 = no sleeve<br>2 = insulated sleeve | B = bulk<br>T = tape and reel<br>G = ammo pack | E3 = 100 % tin termination (RoHS-compliant)<br>Blank = SnPb termination |

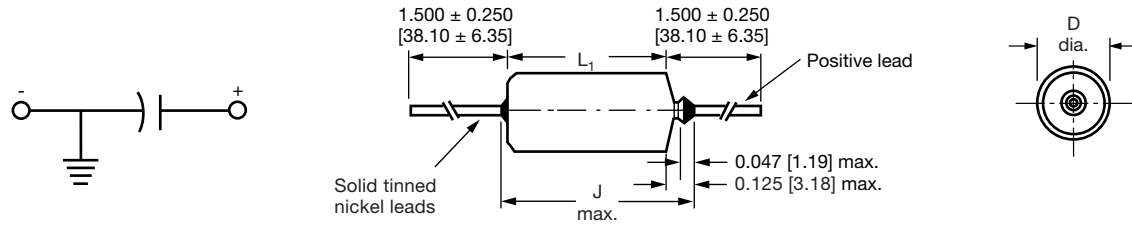
**DIMENSIONS** in inches [millimeters]

| CASE CODE | D                                     | L <sub>1</sub>               | J (MAXIMUM)    | LEAD SIZE |                  |
|-----------|---------------------------------------|------------------------------|----------------|-----------|------------------|
|           | WITH INSULATING SLEEVE <sup>(1)</sup> |                              |                | AWG NO.   | NOMINAL DIAMETER |
| A         | 0.135 ± 0.016 [3.43 ± 0.41]           | 0.286 ± 0.031 [7.26 ± 0.79]  | 0.422 [10.720] | 24        | 0.020 [0.51]     |
| B         | 0.185 ± 0.016 [4.70 ± 0.41]           | 0.474 ± 0.031 [12.04 ± 0.79] | 0.610 [15.490] | 24        | 0.020 [0.51]     |
| R         | 0.289 ± 0.016 [7.34 ± 0.41]           | 0.686 ± 0.031 [17.42 ± 0.79] | 0.822 [20.880] | 22        | 0.025 [0.64]     |
| S         | 0.351 ± 0.016 [8.92 ± 0.41]           | 0.786 ± 0.031 [19.96 ± 0.79] | 0.922 [23.420] | 22        | 0.025 [0.64]     |

**Note**

<sup>(1)</sup> When a shrink-fitted insulation is used, it shall lap over the ends of the capacitor body

**STANDARD RATINGS**

| CAPACITANCE (μF)   | CASE CODE | PART NUMBER             | MAX. DCL AT +25 °C (μA) | MAX. DF AT +25 °C 120 Hz (%) |
|--|-----------|-------------------------|-------------------------|------------------------------|
| <b>6 V<sub>DC</sub> AT +85 °C, SURGE = 8 V; 4 V<sub>DC</sub> AT +125 °C, SURGE = 5 V</b> |           |                         |                         |                              |
| 0.22   | A         | 150D224(1)006A(2)(3)(4) | 0.5                     | 2                            |
| 0.27   | A         | 150D274(1)006A(2)(3)(4) | 0.5                     | 2                            |
| 0.33   | A         | 150D334(1)006A(2)(3)(4) | 0.5                     | 2                            |
| 0.39   | A         | 150D394(1)006A(2)(3)(4) | 0.5                     | 2                            |
| 0.47   | A         | 150D474(1)006A(2)(3)(4) | 0.5                     | 2                            |
| 0.56   | A         | 150D564(1)006A(2)(3)(4) | 0.5                     | 2                            |
| 0.68   | A         | 150D684(1)006A(2)(3)(4) | 0.5                     | 2                            |
| 0.82   | A         | 150D824(1)006A(2)(3)(4) | 0.5                     | 2                            |
| 1.0  | A         | 150D105(1)006A(2)(3)(4) | 0.5                     | 2                            |
| 1.2  | A         | 150D125(1)006A(2)(3)(4) | 0.5                     | 4                            |
| 1.5  | A         | 150D155(1)006A(2)(3)(4) | 0.5                     | 4                            |
| 1.8  | A         | 150D185(1)006A(2)(3)(4) | 0.5                     | 4                            |
| 2.2  | A         | 150D225(1)006A(2)(3)(4) | 0.5                     | 4                            |
| 2.7  | A         | 150D275(1)006A(2)(3)(4) | 0.5                     | 4                            |
| 3.3  | A         | 150D335(1)006A(2)(3)(4) | 0.5                     | 4                            |
| 3.9  | A         | 150D395(1)006A(2)(3)(4) | 0.5                     | 4                            |
| 4.7  | A         | 150D475(1)006A(2)(3)(4) | 0.5                     | 4                            |
| 5.6  | A         | 150D565(1)006A(2)(3)(4) | 0.5                     | 4                            |
| 6.8  | A         | 150D685(1)006A(2)(3)(4) | 0.5                     | 6                            |
| 8.2  | B         | 150D825(1)006B(2)(3)(4) | 0.5                     | 6                            |
| 10   | B         | 150D106(1)006B(2)(3)(4) | 0.5                     | 6                            |
| 12   | B         | 150D126(1)006B(2)(3)(4) | 0.5                     | 6                            |
| 15   | B         | 150D156(1)006B(2)(3)(4) | 1.0                     | 6                            |
| 18   | B         | 150D186(1)006B(2)(3)(4) | 1.0                     | 6                            |
| 22   | B         | 150D226(1)006B(2)(3)(4) | 1.0                     | 6                            |
| 27   | B         | 150D276(1)006B(2)(3)(4) | 1.0                     | 6                            |
| 33   | B         | 150D336(1)006B(2)(3)(4) | 1.0                     | 6                            |
| 39   | B         | 150D396(1)006B(2)(3)(4) | 1.0                     | 6                            |

**Note**

- Part number definitions:
  - For 10 % tolerance specify "X9"; for 20 % specify "X0"; for 5 % "X5" (special order)
  - Style number: 0 = no sleeve, 2 = insulated sleeve
  - Packaging options: B = bulk, T = tape and reel, G = ammo pack
  - Termination: E3 = 100 % tin, blank = SnPb



| STANDARD RATINGS   |           |                         |                                     |                                       |  |
|--|-----------|-------------------------|-------------------------------------|---------------------------------------|--|
| CAPACITANCE<br>( $\mu$ F)  | CASE CODE | PART NUMBER             | MAX. DCL<br>AT +25 °C<br>( $\mu$ A) | MAX. DF<br>AT +25 °C<br>120 Hz<br>(%) |  |
| <b>6 V<sub>DC</sub> AT +85 °C, SURGE = 8 V; 4 V<sub>DC</sub> AT +125 °C, SURGE = 5 V</b>   |           |                         |                                     |                                       |  |
| 47   | B         | 150D476(1)006B(2)(3)(4) | 2.0                                 | 6                                     |  |
| 56   | B         | 150D566(1)006B(2)(3)(4) | 2.0                                 | 6                                     |  |
| 68   | R         | 150D686(1)006R(2)(3)(4) | 3.0                                 | 6                                     |  |
| 82   | R         | 150D826(1)006R(2)(3)(4) | 3.0                                 | 6                                     |  |
| 100  | R         | 150D107(1)006R(2)(3)(4) | 3.0                                 | 6                                     |  |
| 120  | R         | 150D127(1)006R(2)(3)(4) | 3.0                                 | 6                                     |  |
| 150  | R         | 150D157(1)006R(2)(3)(4) | 6.0                                 | 6                                     |  |
| 180  | R         | 150D187(1)006R(2)(3)(4) | 6.0                                 | 6                                     |  |
| 220  | S         | 150D227(1)006S(2)(3)(4) | 6.0                                 | 8                                     |  |
| 270  | S         | 150D277(1)006S(2)(3)(4) | 6.0                                 | 8                                     |  |
| 330  | S         | 150D337(1)006S(2)(3)(4) | 10.0                                | 8                                     |  |
| <b>10 V<sub>DC</sub> AT +85 °C, SURGE = 13 V; 7 V<sub>DC</sub> AT +125 °C, SURGE = 9 V</b> |           |                         |                                     |                                       |  |
| 0.22   | A         | 150D224(1)010A(2)(3)(4) | 0.5                                 | 2                                     |  |
| 0.27   | A         | 150D274(1)010A(2)(3)(4) | 0.5                                 | 2                                     |  |
| 0.33   | A         | 150D334(1)010A(2)(3)(4) | 0.5                                 | 2                                     |  |
| 0.39   | A         | 150D394(1)010A(2)(3)(4) | 0.5                                 | 2                                     |  |
| 0.47   | A         | 150D474(1)010A(2)(3)(4) | 0.5                                 | 2                                     |  |
| 0.56   | A         | 150D564(1)010A(2)(3)(4) | 0.5                                 | 2                                     |  |
| 0.68   | A         | 150D684(1)010A(2)(3)(4) | 0.5                                 | 2                                     |  |
| 0.82   | A         | 150D824(1)010A(2)(3)(4) | 0.5                                 | 2                                     |  |
| 1.0  | A         | 150D105(1)010A(2)(3)(4) | 0.5                                 | 2                                     |  |
| 1.2  | A         | 150D125(1)010A(2)(3)(4) | 0.5                                 | 4                                     |  |
| 1.5  | A         | 150D155(1)010A(2)(3)(4) | 0.5                                 | 4                                     |  |
| 1.8  | A         | 150D185(1)010A(2)(3)(4) | 0.5                                 | 4                                     |  |
| 2.2  | A         | 150D225(1)010A(2)(3)(4) | 0.5                                 | 4                                     |  |
| 2.7  | A         | 150D275(1)010A(2)(3)(4) | 0.5                                 | 4                                     |  |
| 3.3  | A         | 150D335(1)010A(2)(3)(4) | 0.5                                 | 4                                     |  |
| 3.9  | A         | 150D395(1)010A(2)(3)(4) | 0.5                                 | 4                                     |  |
| 4.7  | A         | 150D475(1)010A(2)(3)(4) | 0.5                                 | 4                                     |  |
| 5.6  | B         | 150D565(1)010B(2)(3)(4) | 0.5                                 | 4                                     |  |
| 6.8  | B         | 150D685(1)010B(2)(3)(4) | 1.0                                 | 6                                     |  |
| 8.2  | B         | 150D825(1)010B(2)(3)(4) | 1.0                                 | 6                                     |  |
| 10   | B         | 150D106(1)010B(2)(3)(4) | 1.0                                 | 6                                     |  |
| 12   | B         | 150D126(1)010B(2)(3)(4) | 1.0                                 | 6                                     |  |
| 15   | B         | 150D156(1)010B(2)(3)(4) | 1.0                                 | 6                                     |  |
| 18   | B         | 150D186(1)010B(2)(3)(4) | 1.0                                 | 6                                     |  |
| 22   | B         | 150D226(1)010B(2)(3)(4) | 2.0                                 | 6                                     |  |
| 27   | B         | 150D276(1)010B(2)(3)(4) | 2.0                                 | 6                                     |  |
| 33   | B         | 150D336(1)010B(2)(3)(4) | 2.0                                 | 6                                     |  |
| 39   | B         | 150D396(1)010B(2)(3)(4) | 2.0                                 | 6                                     |  |
| 47   | R         | 150D476(1)010R(2)(3)(4) | 3.0                                 | 6                                     |  |
| 56   | R         | 150D566(1)010R(2)(3)(4) | 3.0                                 | 6                                     |  |
| 68   | R         | 150D686(1)010R(2)(3)(4) | 3.0                                 | 6                                     |  |
| 82   | R         | 150D826(1)010R(2)(3)(4) | 3.0                                 | 6                                     |  |
| 100  | R         | 150D107(1)010R(2)(3)(4) | 6.0                                 | 6                                     |  |
| 120  | R         | 150D127(1)010R(2)(3)(4) | 6.0                                 | 6                                     |  |
| 150  | S         | 150D157(1)010S(2)(3)(4) | 10.0                                | 6                                     |  |
| 180  | S         | 150D187(1)010S(2)(3)(4) | 10.0                                | 6                                     |  |
| 220  | S         | 150D227(1)010S(2)(3)(4) | 10.0                                | 8                                     |  |

**Note**

- Part number definitions:
  - For 10 % tolerance specify "X9"; for 20 % specify "X0"; for 5 % "X5" (special order)
  - Style number: 0 = no sleeve, 2 = insulated sleeve
  - Packaging options: B = bulk, T = tape and reel, G = ammo pack
  - Termination: E3 = 100 % tin, blank = SnPb



| STANDARD RATINGS   |           |                         |                                     |                                       |  |
|--|-----------|-------------------------|-------------------------------------|---------------------------------------|--|
| CAPACITANCE<br>( $\mu$ F)  | CASE CODE | PART NUMBER             | MAX. DCL<br>AT +25 °C<br>( $\mu$ A) | MAX. DF<br>AT +25 °C<br>120 Hz<br>(%) |  |
| <b>15 V<sub>DC</sub> AT +85 °C, SURGE = 20 V; 10 V<sub>DC</sub> AT +125 °C, SURGE = 12 V</b> |           |                         |                                     |                                       |  |
| 0.22   | A         | 150D224(1)015A(2)(3)(4) | 0.5                                 | 2                                     |  |
| 0.27   | A         | 150D274(1)015A(2)(3)(4) | 0.5                                 | 2                                     |  |
| 0.33   | A         | 150D334(1)015A(2)(3)(4) | 0.5                                 | 2                                     |  |
| 0.39   | A         | 150D394(1)015A(2)(3)(4) | 0.5                                 | 2                                     |  |
| 0.47   | A         | 150D474(1)015A(2)(3)(4) | 0.5                                 | 2                                     |  |
| 0.56   | A         | 150D564(1)015A(2)(3)(4) | 0.5                                 | 2                                     |  |
| 0.68   | A         | 150D684(1)015A(2)(3)(4) | 0.5                                 | 2                                     |  |
| 0.82   | A         | 150D824(1)015A(2)(3)(4) | 0.5                                 | 2                                     |  |
| 1.0  | A         | 150D105(1)015A(2)(3)(4) | 0.5                                 | 2                                     |  |
| 1.2  | A         | 150D125(1)015A(2)(3)(4) | 0.5                                 | 4                                     |  |
| 1.5  | A         | 150D155(1)015A(2)(3)(4) | 0.5                                 | 4                                     |  |
| 1.8  | A         | 150D185(1)015A(2)(3)(4) | 0.5                                 | 4                                     |  |
| 2.2  | A         | 150D225(1)015A(2)(3)(4) | 0.5                                 | 4                                     |  |
| 2.7  | A         | 150D275(1)015A(2)(3)(4) | 0.5                                 | 4                                     |  |
| 3.3  | A         | 150D335(1)015A(2)(3)(4) | 0.5                                 | 4                                     |  |
| 3.9  | B         | 150D395(1)015B(2)(3)(4) | 0.5                                 | 4                                     |  |
| 4.7  | B         | 150D475(1)015B(2)(3)(4) | 1.0                                 | 4                                     |  |
| 5.6  | B         | 150D565(1)015B(2)(3)(4) | 1.0                                 | 4                                     |  |
| 6.8  | B         | 150D685(1)015B(2)(3)(4) | 1.0                                 | 6                                     |  |
| 8.2  | B         | 150D825(1)015B(2)(3)(4) | 1.0                                 | 6                                     |  |
| 10   | B         | 150D106(1)015B(2)(3)(4) | 1.0                                 | 6                                     |  |
| 12   | B         | 150D126(1)015B(2)(3)(4) | 1.0                                 | 6                                     |  |
| 15   | B         | 150D156(1)015B(2)(3)(4) | 2.0                                 | 6                                     |  |
| 18   | B         | 150D186(1)015B(2)(3)(4) | 2.0                                 | 6                                     |  |
| 22   | B         | 150D226(1)015B(2)(3)(4) | 3.0                                 | 6                                     |  |
| 27   | R         | 150D276(1)015R(2)(3)(4) | 3.0                                 | 6                                     |  |
| 33   | R         | 150D336(1)015R(2)(3)(4) | 3.0                                 | 6                                     |  |
| 39   | R         | 150D396(1)015R(2)(3)(4) | 3.0                                 | 6                                     |  |
| 47   | R         | 150D476(1)015R(2)(3)(4) | 6.0                                 | 6                                     |  |
| 56   | R         | 150D566(1)015R(2)(3)(4) | 6.0                                 | 6                                     |  |
| 68   | R         | 150D686(1)015R(2)(3)(4) | 6.0                                 | 6                                     |  |
| 82   | S         | 150D826(1)015S(2)(3)(4) | 6.0                                 | 6                                     |  |
| 100  | S         | 150D107(1)015S(2)(3)(4) | 6.0                                 | 6                                     |  |
| 120  | S         | 150D127(1)015S(2)(3)(4) | 6.0                                 | 6                                     |  |
| 150  | S         | 150D157(1)015S(2)(3)(4) | 10.0                                | 6                                     |  |
| <b>20 V<sub>DC</sub> AT +85 °C, SURGE = 26 V; 13 V<sub>DC</sub> AT +125 °C, SURGE = 16 V</b> |           |                         |                                     |                                       |  |
| 0.033  | A         | 150D333(1)020A(2)(3)(4) | 0.1                                 | 2                                     |  |
| 0.039  | A         | 150D393(1)020A(2)(3)(4) | 0.1                                 | 2                                     |  |
| 0.047  | A         | 150D473(1)020A(2)(3)(4) | 0.1                                 | 2                                     |  |
| 0.056  | A         | 150D563(1)020A(2)(3)(4) | 0.1                                 | 2                                     |  |
| 0.068  | A         | 150D683(1)020A(2)(3)(4) | 0.1                                 | 2                                     |  |
| 0.082  | A         | 150D823(1)020A(2)(3)(4) | 0.1                                 | 2                                     |  |
| 0.10   | A         | 150D104(1)020A(2)(3)(4) | 0.5                                 | 2                                     |  |
| 0.12   | A         | 150D124(1)020A(2)(3)(4) | 0.5                                 | 2                                     |  |
| 0.15   | A         | 150D154(1)020A(2)(3)(4) | 0.5                                 | 2                                     |  |
| 0.18   | A         | 150D184(1)020A(2)(3)(4) | 0.5                                 | 2                                     |  |
| 0.22   | A         | 150D224(1)020A(2)(3)(4) | 0.5                                 | 2                                     |  |
| 0.27   | A         | 150D274(1)020A(2)(3)(4) | 0.5                                 | 2                                     |  |
| 0.33   | A         | 150D334(1)020A(2)(3)(4) | 0.5                                 | 2                                     |  |

Note

- Part number definitions:
  - (1) For 10 % tolerance specify "X9"; for 20 % specify "X0"; for 5 % "X5" (special order)
  - (2) Style number: 0 = no sleeve, 2 = insulated sleeve
  - (3) Packaging options: B = bulk, T = tape and reel, G = ammo pack
  - (4) Termination: E3 = 100 % tin, blank = SnPb



| STANDARD RATINGS   |           |                         |                                     |                                       |  |
|--|-----------|-------------------------|-------------------------------------|---------------------------------------|--|
| CAPACITANCE<br>( $\mu$ F)  | CASE CODE | PART NUMBER             | MAX. DCL<br>AT +25 °C<br>( $\mu$ A) | MAX. DF<br>AT +25 °C<br>120 Hz<br>(%) |  |
| <b>20 V<sub>DC</sub> AT +85 °C, SURGE = 26 V; 13 V<sub>DC</sub> AT +125 °C, SURGE = 16 V</b> |           |                         |                                     |                                       |  |
| 0.39   | A         | 150D394(1)020A(2)(3)(4) | 0.5                                 | 2                                     |  |
| 0.47   | A         | 150D474(1)020A(2)(3)(4) | 0.5                                 | 2                                     |  |
| 0.56   | A         | 150D564(1)020A(2)(3)(4) | 0.5                                 | 2                                     |  |
| 0.68   | A         | 150D684(1)020A(2)(3)(4) | 0.5                                 | 2                                     |  |
| 0.82   | A         | 150D824(1)020A(2)(3)(4) | 0.5                                 | 2                                     |  |
| 1.0  | A         | 150D105(1)020A(2)(3)(4) | 0.5                                 | 2                                     |  |
| 1.2  | A         | 150D125(1)020A(2)(3)(4) | 0.5                                 | 4                                     |  |
| 1.5  | A         | 150D155(1)020A(2)(3)(4) | 0.5                                 | 4                                     |  |
| 1.8  | A         | 150D185(1)020A(2)(3)(4) | 0.5                                 | 4                                     |  |
| 2.2  | A         | 150D225(1)020A(2)(3)(4) | 0.5                                 | 4                                     |  |
| 2.7  | B         | 150D275(1)020B(2)(3)(4) | 0.5                                 | 4                                     |  |
| 3.3  | B         | 150D335(1)020B(2)(3)(4) | 0.5                                 | 4                                     |  |
| 3.9  | B         | 150D395(1)020B(2)(3)(4) | 1.0                                 | 4                                     |  |
| 4.7  | B         | 150D475(1)020B(2)(3)(4) | 1.0                                 | 4                                     |  |
| 5.6  | B         | 150D565(1)020B(2)(3)(4) | 1.0                                 | 4                                     |  |
| 6.8  | B         | 150D685(1)020B(2)(3)(4) | 1.0                                 | 6                                     |  |
| 8.2  | B         | 150D825(1)020B(2)(3)(4) | 1.0                                 | 6                                     |  |
| 10   | B         | 150D106(1)020B(2)(3)(4) | 1.0                                 | 6                                     |  |
| 12   | B         | 150D126(1)020B(2)(3)(4) | 1.0                                 | 6                                     |  |
| 15   | B         | 150D156(1)020B(2)(3)(4) | 2.0                                 | 6                                     |  |
| 18   | R         | 150D186(1)020R(2)(3)(4) | 3.0                                 | 6                                     |  |
| 22   | R         | 150D226(1)020R(2)(3)(4) | 3.0                                 | 6                                     |  |
| 27   | R         | 150D276(1)020R(2)(3)(4) | 3.0                                 | 6                                     |  |
| 33   | R         | 150D336(1)020R(2)(3)(4) | 3.0                                 | 6                                     |  |
| 39   | R         | 150D396(1)020R(2)(3)(4) | 3.0                                 | 6                                     |  |
| 47   | R         | 150D476(1)020R(2)(3)(4) | 6.0                                 | 6                                     |  |
| 56   | S         | 150D566(1)020S(2)(3)(4) | 6.0                                 | 6                                     |  |
| 68   | S         | 150D686(1)020S(2)(3)(4) | 6.0                                 | 6                                     |  |
| 82   | S         | 150D826(1)020S(2)(3)(4) | 6.0                                 | 6                                     |  |
| 100  | S         | 150D107(1)020S(2)(3)(4) | 10.0                                | 6                                     |  |
| <b>25 V<sub>DC</sub> AT +85 °C, SURGE = 32 V; 17 V<sub>DC</sub> AT +125 °C, SURGE = 21 V</b> |           |                         |                                     |                                       |  |
| 1.2  | A         | 150D125(1)025A(2)(3)(4) | 0.5                                 | 4                                     |  |
| 1.5  | A         | 150D155(1)025A(2)(3)(4) | 0.5                                 | 4                                     |  |
| 1.8  | A         | 150D185(1)025A(2)(3)(4) | 0.5                                 | 4                                     |  |
| 4.7  | B         | 150D475(1)025B(2)(3)(4) | 1.2                                 | 4                                     |  |
| 5.6  | B         | 150D565(1)025B(2)(3)(4) | 1.4                                 | 4                                     |  |
| 6.8  | B         | 150D685(1)025B(2)(3)(4) | 1.7                                 | 4                                     |  |
| 8.2  | B         | 150D825(1)025B(2)(3)(4) | 2.1                                 | 4                                     |  |
| 10   | B         | 150D106(1)025B(2)(3)(4) | 2.5                                 | 6                                     |  |
| 15   | B         | 150D156(1)025B(2)(3)(4) | 3.8                                 | 6                                     |  |
| 33   | R         | 150D336(1)025R(2)(3)(4) | 8.3                                 | 6                                     |  |
| 68   | S         | 150D686(1)025S(2)(3)(4) | 17                                  | 6                                     |  |
| 100  | S         | 150D107(1)025S(2)(3)(4) | 25                                  | 6                                     |  |
| <b>35 V<sub>DC</sub> AT +85 °C, SURGE = 46 V; 23 V<sub>DC</sub> AT +125 °C, SURGE = 28 V</b> |           |                         |                                     |                                       |  |
| 0.033  | A         | 150D333(1)035A(2)(3)(4) | 0.1                                 | 2                                     |  |
| 0.039  | A         | 150D393(1)035A(2)(3)(4) | 0.1                                 | 2                                     |  |
| 0.047  | A         | 150D473(1)035A(2)(3)(4) | 0.1                                 | 2                                     |  |
| 0.056  | A         | 150D563(1)035A(2)(3)(4) | 0.1                                 | 2                                     |  |
| 0.068  | A         | 150D683(1)035A(2)(3)(4) | 0.1                                 | 2                                     |  |

**Note**

- Part number definitions:
  - For 10 % tolerance specify "X9"; for 20 % specify "X0"; for 5 % "X5" (special order)
  - Style number: 0 = no sleeve, 2 = insulated sleeve
  - Packaging options: B = bulk, T = tape and reel, G = ammo pack
  - Termination: E3 = 100 % tin, blank = SnPb



| STANDARD RATINGS   |           |                         |                                     |                                       |  |
|--|-----------|-------------------------|-------------------------------------|---------------------------------------|--|
| CAPACITANCE<br>( $\mu$ F)  | CASE CODE | PART NUMBER             | MAX. DCL<br>AT +25 °C<br>( $\mu$ A) | MAX. DF<br>AT +25 °C<br>120 Hz<br>(%) |  |
| <b>35 V<sub>DC</sub> AT +85 °C, SURGE = 46 V; 23 V<sub>DC</sub> AT +125 °C, SURGE = 28 V</b> |           |                         |                                     |                                       |  |
| 0.082  | A         | 150D823(1)035A(2)(3)(4) | 0.1                                 | 2                                     |  |
| 0.10   | A         | 150D104(1)035A(2)(3)(4) | 0.5                                 | 2                                     |  |
| 0.12   | A         | 150D124(1)035A(2)(3)(4) | 0.5                                 | 2                                     |  |
| 0.15   | A         | 150D154(1)035A(2)(3)(4) | 0.5                                 | 2                                     |  |
| 0.18   | A         | 150D184(1)035A(2)(3)(4) | 0.5                                 | 2                                     |  |
| 0.22   | A         | 150D224(1)035A(2)(3)(4) | 0.5                                 | 2                                     |  |
| 0.27   | A         | 150D274(1)035A(2)(3)(4) | 0.5                                 | 2                                     |  |
| 0.33   | A         | 150D334(1)035A(2)(3)(4) | 0.5                                 | 2                                     |  |
| 0.39   | A         | 150D394(1)035A(2)(3)(4) | 0.5                                 | 2                                     |  |
| 0.47   | A         | 150D474(1)035A(2)(3)(4) | 0.5                                 | 2                                     |  |
| 0.56   | A         | 150D564(1)035A(2)(3)(4) | 0.5                                 | 2                                     |  |
| 0.68   | A         | 150D684(1)035A(2)(3)(4) | 0.5                                 | 2                                     |  |
| 0.82   | A         | 150D824(1)035A(2)(3)(4) | 0.5                                 | 2                                     |  |
| 1.0  | A         | 150D105(1)035A(2)(3)(4) | 0.5                                 | 2                                     |  |
| 1.2  | B         | 150D125(1)035B(2)(3)(4) | 0.5                                 | 4                                     |  |
| 1.5  | B         | 150D155(1)035B(2)(3)(4) | 0.5                                 | 4                                     |  |
| 1.8  | B         | 150D185(1)035B(2)(3)(4) | 0.5                                 | 4                                     |  |
| 2.2  | B         | 150D225(1)035B(2)(3)(4) | 1.0                                 | 4                                     |  |
| 2.7  | B         | 150D275(1)035B(2)(3)(4) | 1.0                                 | 4                                     |  |
| 3.3  | B         | 150D335(1)035B(2)(3)(4) | 1.0                                 | 4                                     |  |
| 3.9  | B         | 150D395(1)035B(2)(3)(4) | 1.0                                 | 4                                     |  |
| 4.7  | B         | 150D475(1)035B(2)(3)(4) | 1.0                                 | 4                                     |  |
| 5.6  | B         | 150D565(1)035B(2)(3)(4) | 1.0                                 | 4                                     |  |
| 6.8  | B         | 150D685(1)035B(2)(3)(4) | 2.0                                 | 4                                     |  |
| 8.2  | R         | 150D825(1)035R(2)(3)(4) | 3.0                                 | 4                                     |  |
| 10   | R         | 150D106(1)035R(2)(3)(4) | 3.0                                 | 4                                     |  |
| 12   | R         | 150D126(1)035R(2)(3)(4) | 3.0                                 | 4                                     |  |
| 15   | R         | 150D156(1)035R(2)(3)(4) | 3.0                                 | 4                                     |  |
| 18   | R         | 150D186(1)035R(2)(3)(4) | 3.0                                 | 4                                     |  |
| 22   | R         | 150D226(1)035R(2)(3)(4) | 6.0                                 | 4                                     |  |
| 27   | S         | 150D276(1)035S(2)(3)(4) | 6.0                                 | 4                                     |  |
| 33   | S         | 150D336(1)035S(2)(3)(4) | 6.0                                 | 4                                     |  |
| 39   | S         | 150D396(1)035S(2)(3)(4) | 6.0                                 | 4                                     |  |
| 47   | S         | 150D476(1)035S(2)(3)(4) | 10.0                                | 4                                     |  |
| <b>50 V<sub>DC</sub> AT +85 °C, SURGE = 65 V; 33 V<sub>DC</sub> AT +125 °C, SURGE = 40 V</b> |           |                         |                                     |                                       |  |
| 0.056  | A         | 150D563(1)050A(2)(3)(4) | 0.1                                 | 2                                     |  |
| 0.068  | A         | 150D683(1)050A(2)(3)(4) | 0.1                                 | 2                                     |  |
| 0.082  | A         | 150D823(1)050A(2)(3)(4) | 0.1                                 | 2                                     |  |
| 0.10   | A         | 150D104(1)050A(2)(3)(4) | 0.5                                 | 2                                     |  |
| 0.12   | A         | 150D124(1)050A(2)(3)(4) | 0.5                                 | 2                                     |  |
| 0.15   | A         | 150D154(1)050A(2)(3)(4) | 0.5                                 | 2                                     |  |
| 0.18   | A         | 150D184(1)050A(2)(3)(4) | 0.5                                 | 2                                     |  |
| 0.22   | A         | 150D224(1)050A(2)(3)(4) | 0.5                                 | 2                                     |  |
| 0.27   | A         | 150D274(1)050A(2)(3)(4) | 0.5                                 | 2                                     |  |
| 0.33   | A         | 150D334(1)050A(2)(3)(4) | 0.5                                 | 2                                     |  |
| 0.39   | A         | 150D394(1)050A(2)(3)(4) | 0.5                                 | 2                                     |  |
| 0.47   | A         | 150D474(1)050A(2)(3)(4) | 0.5                                 | 2                                     |  |
| 0.56   | A         | 150D564(1)050A(2)(3)(4) | 0.5                                 | 2                                     |  |
| 0.68   | A         | 150D684(1)050A(2)(3)(4) | 0.5                                 | 2                                     |  |

Note

- Part number definitions:
  - For 10 % tolerance specify "X9"; for 20 % specify "X0"; for 5 % "X5" (special order)
  - Style number: 0 = no sleeve, 2 = insulated sleeve
  - Packaging options: B = bulk, T = tape and reel, G = ammo pack
  - Termination: E3 = 100 % tin, blank = SnPb



| STANDARD RATINGS   |           |                         |                                     |                                       |     |
|--|-----------|-------------------------|-------------------------------------|---------------------------------------|-----|
| CAPACITANCE<br>( $\mu$ F)  | CASE CODE | PART NUMBER             | MAX. DCL<br>AT +25 °C<br>( $\mu$ A) | MAX. DF<br>AT +25 °C<br>120 Hz<br>(%) |     |
| <b>50 V<sub>DC</sub> AT +85 °C, SURGE = 65 V; 33 V<sub>DC</sub> AT +125 °C, SURGE = 40 V</b> |           |                         |                                     |                                       |     |
| 0.82   | A         | 150D824(1)050A(2)(3)(4) | 0.5                                 |                                       | 2   |
| 1.0  | A         | 150D105(1)050A(2)(3)(4) | 0.5                                 |                                       | 2   |
| 1.2  | B         | 150D125(1)050B(2)(3)(4) | 0.5                                 |                                       | 4   |
| 1.5  | B         | 150D155(1)050B(2)(3)(4) | 0.5                                 |                                       | 4   |
| 1.8  | B         | 150D185(1)050B(2)(3)(4) | 0.5                                 |                                       | 4   |
| 2.2  | B         | 150D225(1)050B(2)(3)(4) | 1.0                                 |                                       | 4   |
| 2.7  | B         | 150D275(1)050B(2)(3)(4) | 1.0                                 |                                       | 4   |
| 3.3  | B         | 150D335(1)050B(2)(3)(4) | 2.0                                 |                                       | 4   |
| 3.9  | B         | 150D395(1)050B(2)(3)(4) | 2.0                                 |                                       | 4   |
| 4.7  | B         | 150D475(1)050B(2)(3)(4) | 3.0                                 |                                       | 4   |
| 5.6  | R         | 150D565(1)050R(2)(3)(4) | 3.0                                 |                                       | 4   |
| 6.8  | R         | 150D685(1)050R(2)(3)(4) | 3.0                                 |                                       | 4   |
| 8.2  | R         | 150D825(1)050R(2)(3)(4) | 3.0                                 |                                       | 4   |
| 10   | R         | 150D106(1)050R(2)(3)(4) | 3.0                                 |                                       | 4   |
| 12   | R         | 150D126(1)050R(2)(3)(4) | 3.0                                 |                                       | 4   |
| 15   | R         | 150D156(1)050R(2)(3)(4) | 6.0                                 |                                       | 4   |
| 18   | R         | 150D186(1)050R(2)(3)(4) | 6.0                                 |                                       | 4   |
| 22   | S         | 150D226(1)050S(2)(3)(4) | 6.0                                 |                                       | 4   |
| <b>60 V<sub>DC</sub> AT +85 °C, SURGE = 78 V; 40 V<sub>DC</sub> AT +125 °C, SURGE = 49 V</b> |           |                         |                                     |                                       |     |
| 0.10   | A         | 150D104(1)060A(2)(3)(4) | 0.5                                 |                                       | 4.0 |
| 0.12   | A         | 150D124(1)060A(2)(3)(4) | 0.5                                 |                                       | 4.0 |
| 0.15   | A         | 150D154(1)060A(2)(3)(4) | 0.5                                 |                                       | 4.0 |
| 0.18   | A         | 150D184(1)060A(2)(3)(4) | 0.5                                 |                                       | 4.0 |
| 0.22   | A         | 150D224(1)060A(2)(3)(4) | 0.5                                 |                                       | 4.0 |
| 0.27   | A         | 150D274(1)060A(2)(3)(4) | 0.5                                 |                                       | 4.0 |
| 0.33   | A         | 150D334(1)060A(2)(3)(4) | 0.5                                 |                                       | 4.0 |
| 0.39   | A         | 150D394(1)060A(2)(3)(4) | 0.5                                 |                                       | 4.0 |
| 0.47   | A         | 150D474(1)060A(2)(3)(4) | 0.5                                 |                                       | 4.0 |
| 0.56   | A         | 150D564(1)060A(2)(3)(4) | 0.5                                 |                                       | 4.0 |
| 0.68   | A         | 150D684(1)060A(2)(3)(4) | 0.5                                 |                                       | 4.0 |
| 1.0  | B         | 150D105(1)060B(2)(3)(4) | 0.5                                 |                                       | 4.0 |
| 2.2  | B         | 150D225(1)060B(2)(3)(4) | 1.0                                 |                                       | 4.0 |
| 4.7  | R         | 150D475(1)060R(2)(3)(4) | 3.0                                 |                                       | 6.0 |
| 5.6  | R         | 150D565(1)060R(2)(3)(4) | 3.0                                 |                                       | 6.0 |
| 6.8  | R         | 150D685(1)060R(2)(3)(4) | 4.0                                 |                                       | 6.0 |
| 8.2  | R         | 150D825(1)060R(2)(3)(4) | 5.0                                 |                                       | 6.0 |
| 10   | R         | 150D106(1)060R(2)(3)(4) | 6.0                                 |                                       | 6.0 |
| 12   | S         | 150D126(1)060S(2)(3)(4) | 6.0                                 |                                       | 6.0 |
| 15   | S         | 150D156(1)060S(2)(3)(4) | 9.0                                 |                                       | 6.0 |
| 18   | S         | 150D186(1)060S(2)(3)(4) | 10.0                                |                                       | 6.0 |
| 22   | S         | 150D226(1)060S(2)(3)(4) | 12.0                                |                                       | 6.0 |
| <b>75 V<sub>DC</sub> AT +85 °C, SURGE = 98 V; 50 V<sub>DC</sub> AT +125 °C, SURGE = 64 V</b> |           |                         |                                     |                                       |     |
| 0.033  | A         | 150D333(1)075A(2)(3)(4) | 0.5                                 |                                       | 2   |
| 0.039  | A         | 150D393(1)075A(2)(3)(4) | 0.5                                 |                                       | 2   |
| 0.047  | A         | 150D473(1)075A(2)(3)(4) | 0.5                                 |                                       | 2   |
| 0.056  | A         | 150D563(1)075A(2)(3)(4) | 0.5                                 |                                       | 2   |
| 0.068  | A         | 150D683(1)075A(2)(3)(4) | 0.5                                 |                                       | 2   |
| 0.082  | A         | 150D823(1)075A(2)(3)(4) | 0.5                                 |                                       | 2   |
| 0.10   | A         | 150D104(1)075A(2)(3)(4) | 0.5                                 |                                       | 2   |

**Note**

- Part number definitions:
  - For 10 % tolerance specify "X9"; for 20 % specify "X0"; for 5 % "X5" (special order)
  - Style number: 0 = no sleeve, 2 = insulated sleeve
  - Packaging options: B = bulk, T = tape and reel, G = ammo pack
  - Termination: E3 = 100 % tin, blank = SnPb



| STANDARD RATINGS   |           |                         |                                     |                                       |   |
|--|-----------|-------------------------|-------------------------------------|---------------------------------------|---|
| CAPACITANCE<br>( $\mu$ F)  | CASE CODE | PART NUMBER             | MAX. DCL<br>AT +25 °C<br>( $\mu$ A) | MAX. DF<br>AT +25 °C<br>120 Hz<br>(%) |   |
| <b>75 V<sub>DC</sub> AT +85 °C, SURGE = 98 V; 50 V<sub>DC</sub> AT +125 °C, SURGE = 64 V</b>   |           |                         |                                     |                                       |   |
| 0.12   | A         | 150D124(1)075A(2)(3)(4) | 0.5                                 |                                       | 2 |
| 0.15   | A         | 150D154(1)075A(2)(3)(4) | 0.5                                 |                                       | 2 |
| 0.18   | A         | 150D184(1)075A(2)(3)(4) | 0.5                                 |                                       | 2 |
| 0.22   | A         | 150D224(1)075A(2)(3)(4) | 0.5                                 |                                       | 2 |
| 0.27   | A         | 150D274(1)075A(2)(3)(4) | 0.5                                 |                                       | 2 |
| 0.33   | A         | 150D334(1)075A(2)(3)(4) | 0.5                                 |                                       | 2 |
| 0.39   | A         | 150D394(1)075A(2)(3)(4) | 0.5                                 |                                       | 2 |
| 0.47   | A         | 150D474(1)075A(2)(3)(4) | 0.5                                 |                                       | 2 |
| 0.56   | A         | 150D564(1)075A(2)(3)(4) | 0.5                                 |                                       | 2 |
| 0.68   | A         | 150D684(1)075A(2)(3)(4) | 0.5                                 |                                       | 2 |
| 0.82   | B         | 150D824(1)075B(2)(3)(4) | 0.5                                 |                                       | 2 |
| 1.0  | B         | 150D105(1)075B(2)(3)(4) | 0.5                                 |                                       | 2 |
| 1.2  | B         | 150D125(1)075B(2)(3)(4) | 0.5                                 |                                       | 4 |
| 1.5  | B         | 150D155(1)075B(2)(3)(4) | 1.0                                 |                                       | 4 |
| 1.8  | B         | 150D185(1)075B(2)(3)(4) | 1.0                                 |                                       | 4 |
| 2.2  | B         | 150D225(1)075B(2)(3)(4) | 1.0                                 |                                       | 4 |
| 2.7  | B         | 150D275(1)075B(2)(3)(4) | 1.0                                 |                                       | 4 |
| 3.3  | B         | 150D335(1)075B(2)(3)(4) | 2.0                                 |                                       | 4 |
| 3.9  | B         | 150D395(1)075B(2)(3)(4) | 2.0                                 |                                       | 4 |
| 4.7  | R         | 150D475(1)075R(2)(3)(4) | 4.0                                 |                                       | 4 |
| 5.6  | R         | 150D565(1)075R(2)(3)(4) | 4.0                                 |                                       | 4 |
| 6.8  | R         | 150D685(1)075R(2)(3)(4) | 6.0                                 |                                       | 4 |
| 8.2  | R         | 150D825(1)075R(2)(3)(4) | 6.0                                 |                                       | 4 |
| 10   | R         | 150D106(1)075R(2)(3)(4) | 8.0                                 |                                       | 4 |
| 12   | S         | 150D126(1)075S(2)(3)(4) | 10.0                                |                                       | 4 |
| 15   | S         | 150D156(1)075S(2)(3)(4) | 12.0                                |                                       | 4 |
| <b>100 V<sub>DC</sub> AT +85 °C, SURGE = 130 V; 67 V<sub>DC</sub> AT +125 °C, SURGE = 86 V</b> |           |                         |                                     |                                       |   |
| 0.033  | A         | 150D333(1)100A(2)(3)(4) | 0.5                                 |                                       | 2 |
| 0.039  | A         | 150D393(1)100A(2)(3)(4) | 0.5                                 |                                       | 2 |
| 0.047  | A         | 150D473(1)100A(2)(3)(4) | 0.5                                 |                                       | 2 |
| 0.056  | A         | 150D563(1)100A(2)(3)(4) | 0.5                                 |                                       | 2 |
| 0.068  | A         | 150D683(1)100A(2)(3)(4) | 0.5                                 |                                       | 2 |
| 0.082  | A         | 150D823(1)100A(2)(3)(4) | 0.5                                 |                                       | 2 |
| 0.10   | A         | 150D104(1)100A(2)(3)(4) | 0.5                                 |                                       | 2 |
| 0.12   | A         | 150D124(1)100A(2)(3)(4) | 0.5                                 |                                       | 2 |
| 0.15   | A         | 150D154(1)100A(2)(3)(4) | 0.5                                 |                                       | 2 |
| 0.18   | A         | 150D184(1)100A(2)(3)(4) | 0.5                                 |                                       | 2 |
| 0.22   | A         | 150D224(1)100A(2)(3)(4) | 0.5                                 |                                       | 2 |
| 0.27   | A         | 150D274(1)100A(2)(3)(4) | 0.5                                 |                                       | 2 |
| 0.33   | A         | 150D334(1)100A(2)(3)(4) | 0.5                                 |                                       | 2 |
| 0.39   | A         | 150D394(1)100A(2)(3)(4) | 0.5                                 |                                       | 2 |
| 0.47   | A         | 150D474(1)100A(2)(3)(4) | 0.5                                 |                                       | 2 |
| 0.56   | A         | 150D564(1)100A(2)(3)(4) | 0.5                                 |                                       | 2 |
| 0.68   | B         | 150D684(1)100B(2)(3)(4) | 0.5                                 |                                       | 2 |
| 0.82   | B         | 150D824(1)100B(2)(3)(4) | 0.5                                 |                                       | 2 |
| 1.0  | B         | 150D105(1)100B(2)(3)(4) | 0.5                                 |                                       | 2 |
| 1.2  | B         | 150D125(1)100B(2)(3)(4) | 0.5                                 |                                       | 3 |
| 1.5  | B         | 150D155(1)100B(2)(3)(4) | 0.6                                 |                                       | 3 |
| 1.8  | B         | 150D185(1)100B(2)(3)(4) | 0.6                                 |                                       | 3 |
| 2.2  | B         | 150D225(1)100B(2)(3)(4) | 0.6                                 |                                       | 3 |

**Note**

- Part number definitions:
  - For 10 % tolerance specify "X9"; for 20 % specify "X0"; for 5 % "X5" (special order)
  - Style number: 0 = no sleeve, 2 = insulated sleeve
  - Packaging options: B = bulk, T = tape and reel, G = ammo pack
  - Termination: E3 = 100 % tin, blank = SnPb



| STANDARD RATINGS   |           |                         |                                     |                                       |
|--|-----------|-------------------------|-------------------------------------|---------------------------------------|
| CAPACITANCE<br>( $\mu$ F)  | CASE CODE | PART NUMBER             | MAX. DCL<br>AT +25 °C<br>( $\mu$ A) | MAX. DF<br>AT +25 °C<br>120 Hz<br>(%) |
| <b>100 V<sub>DC</sub> AT +85 °C, SURGE = 130 V; 67 V<sub>DC</sub> AT +125 °C, SURGE = 86 V</b> |           |                         |                                     |                                       |
| 2.7  | B         | 150D275(1)100B(2)(3)(4) | 0.6                                 | 3                                     |
| 3.3  | R         | 150D335(1)100R(2)(3)(4) | 2.5                                 | 3                                     |
| 3.9  | R         | 150D395(1)100R(2)(3)(4) | 3.0                                 | 3                                     |
| 4.7  | R         | 150D475(1)100R(2)(3)(4) | 4.0                                 | 3                                     |
| 5.6  | R         | 150D565(1)100R(2)(3)(4) | 4.0                                 | 3                                     |
| 6.8  | R         | 150D685(1)100R(2)(3)(4) | 6.0                                 | 3                                     |
| 8.2  | S         | 150D825(1)100S(2)(3)(4) | 6.0                                 | 3                                     |
| 10   | S         | 150D106(1)100S(2)(3)(4) | 6.0                                 | 3                                     |
| <b>125 V<sub>DC</sub> AT +85 °C, SURGE = 140 V; 82 V<sub>DC</sub> AT +125 °C, SURGE = 94 V</b> |           |                         |                                     |                                       |
| 0.027  | A         | 150D273(1)125A(2)(3)(4) | 1.0                                 | 2                                     |
| 0.033  | A         | 150D333(1)125A(2)(3)(4) | 1.0                                 | 2                                     |
| 0.039  | A         | 150D393(1)125A(2)(3)(4) | 1.0                                 | 2                                     |
| 0.047  | A         | 150D473(1)125A(2)(3)(4) | 1.0                                 | 2                                     |
| 0.056  | A         | 150D563(1)125A(2)(3)(4) | 1.0                                 | 2                                     |
| 0.068  | A         | 150D683(1)125A(2)(3)(4) | 1.0                                 | 2                                     |
| 0.082  | A         | 150D823(1)125A(2)(3)(4) | 1.0                                 | 2                                     |
| 0.10   | A         | 150D104(1)125A(2)(3)(4) | 1.0                                 | 2                                     |
| 0.12   | A         | 150D124(1)125A(2)(3)(4) | 1.0                                 | 2                                     |
| 0.15   | A         | 150D154(1)125A(2)(3)(4) | 1.0                                 | 2                                     |
| 0.18   | A         | 150D184(1)125A(2)(3)(4) | 1.0                                 | 2                                     |
| 0.22   | A         | 150D224(1)125A(2)(3)(4) | 1.0                                 | 2                                     |
| 0.27   | A         | 150D274(1)125A(2)(3)(4) | 1.0                                 | 2                                     |
| 0.33   | A         | 150D334(1)125A(2)(3)(4) | 1.0                                 | 2                                     |
| 0.39   | A         | 150D394(1)125A(2)(3)(4) | 1.5                                 | 2                                     |
| 0.47   | A         | 150D474(1)125A(2)(3)(4) | 1.5                                 | 2                                     |
| 0.56   | B         | 150D564(1)125B(2)(3)(4) | 1.6                                 | 2                                     |
| 0.68   | B         | 150D684(1)125B(2)(3)(4) | 1.8                                 | 2                                     |
| 0.82   | B         | 150D824(1)125B(2)(3)(4) | 2.0                                 | 2                                     |
| 1.0  | B         | 150D105(1)125B(2)(3)(4) | 2.0                                 | 2                                     |
| 1.2  | B         | 150D125(1)125B(2)(3)(4) | 2.0                                 | 3                                     |
| 1.5  | B         | 150D155(1)125B(2)(3)(4) | 2.0                                 | 3                                     |
| 1.8  | B         | 150D185(1)125B(2)(3)(4) | 2.0                                 | 3                                     |
| 2.2  | B         | 150D225(1)125B(2)(3)(4) | 2.0                                 | 3                                     |

**Note**

- Part number definitions:
  - For 10 % tolerance specify "X9"; for 20 % specify "X0"; for 5 % "X5" (special order)
  - Style number: 0 = no sleeve, 2 = insulated sleeve
  - Packaging options: B = bulk, T = tape and reel, G = ammo pack
  - Termination: E3 = 100 % tin, blank = SnPb

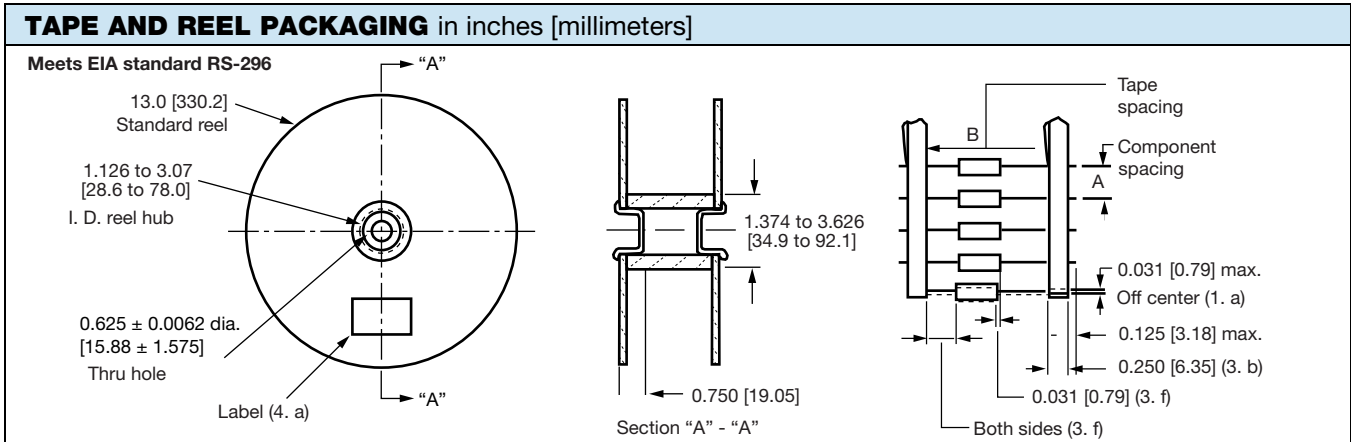



| STANDARD PACKAGING QUANTITY AND DIMENSIONS in inches [millimeters] |                                 |                                 |                |                           |               |
|--|---------------------------------|---------------------------------|----------------|---------------------------|---------------|
| CASE CODE  | COMPONENT SPACING A             | TAPE AND REEL                   |                | AMMO PACK                 |               |
|  |                                 | TAPE SPACING B                  | UNITS PER REEL | TAPE SPACING B            | UNITS PER BOX |
| A  | 0.200 ± 0.015<br>[5.08 ± 0.38]  | 2.500 ± 0.062<br>[63.5 ± 1.57]  | 1000           | 2.063 ± 0.073<br>[53 ± 2] | 500           |
| B  | 0.200 ± 0.015<br>[5.08 ± 0.38]  | 2.500 ± 0.062<br>[63.5 ± 1.57]  | 1000           | 2.063 ± 0.073<br>[53 ± 2] | 500           |
| R  | 0.400 ± 0.015<br>[10.16 ± 0.38] | 2.875 ± 0.062<br>[73.03 ± 1.57] | 500            | 2.063 ± 0.073<br>[53 ± 2] | 250           |
| S  | 0.400 ± 0.015<br>[10.16 ± 0.38] | 2.875 ± 0.062<br>[73.03 ± 1.57] | 500            | 2.063 ± 0.073<br>[53 ± 2] | 250           |

STANDARD REEL PACKAGING INFORMATION

1. Component Leads

- a. Component leads shall not be bent beyond 0.047" [1.19 mm] maximum from their nominal position when measured from the leading edge of the component lead at the inside tape edge and at the lead egress from the component.
- b. The "C" dimension shall be governed by the overall length of the reel packaged component. The distance between flanges shall be 0.125" to 0.250" [3.18 mm to 6.35 mm] greater than the overall component length.

2. Orientation

All polarized components must be oriented to one direction. The cathode lead tape shall be a color and the anode lead tape shall be white.

3. Reeling

- a. Components on any reel shall not represent more than two date codes when date code identification is required.
- b. Component leads shall be positioned between pairs of 0.250" [6.35 mm] tape.
- c. The disposable reels have hubs and corrugated fibreboard flanges and core or equivalent.
- d. A minimum of 12.0" [304.8 mm] leader of tape shall be provided before the first and after the last component on the reel.
- e. 50 lb or 60 lb. Kraft paper must be wound between layer of components as far as necessary for component protection. Width of paper to be 0.062" to 0.250" [1.57 mm to 6.35 mm] less than the "C" dimension of the reel. Solid-electrolyte TANTALEX capacitors hermetically-sealed, axial-lead.

- f. A row of components must be centered between tapes ± 0.047" [1.19 mm]. In addition, individual components may deviate from center of component row ± 0.031" [0.79 mm].
- g. Staples shall not be used for splicing. Not more than 4 layers of tape shall be used in any splice area and no tape shall be offset from another by more than 0.031" [0.79 mm] non-cumulative. Tape splices shall overlap at least 6.0" [152.4 mm] for butt joints and at least 3.0" [76.2 mm] for lap joints and shall not be weaker than unspliced tape. Universal splicing clips may also be used.
- h. Quantity per reel shall be controlled so that tape components and cover shall not extend beyond the smallest dimension of the flange (either across flats or diameter). Once the quantity per reel for each part number has been established, future orders for that part number shall be packaged in that quantity. When order or release quantity is less than the established quantity, a standard commercial pack is to be used.
- i. A maximum of 0.25 % of the components per reel quantity may be missing without consecutive missing components.
- j. Adequate protection must be provided to prevent physical damage to both reel and components during shipment and storage.

4. Marking

Minimum reel and carton marking shall consist of the following: customer part number, purchase order no., quantity, package date, manufacturer's name, electrical value, date code, Vishay Sprague part number and country of origin.

| PRODUCT INFORMATION  |  |
|--|--|
| Mounting of Through Hole Components  | <a href="http://www.vishay.com/doc?40108">www.vishay.com/doc?40108</a> |
| Solid Tantalum Capacitors (With MnO <sub>2</sub> Electrolyte) Voltage Derating | <a href="http://www.vishay.com/doc?40246">www.vishay.com/doc?40246</a> |
| SELECTOR GUIDES  |  |
| Selector Guide   | <a href="http://www.vishay.com/doc?49054">www.vishay.com/doc?49054</a> |
| FAQ  |  |
| Frequently Asked Questions   | <a href="http://www.vishay.com/doc?40110">www.vishay.com/doc?40110</a> |



TYPICAL CURVES AT +25 °C, IMPEDANCE AND ESR VS. FREQUENCY

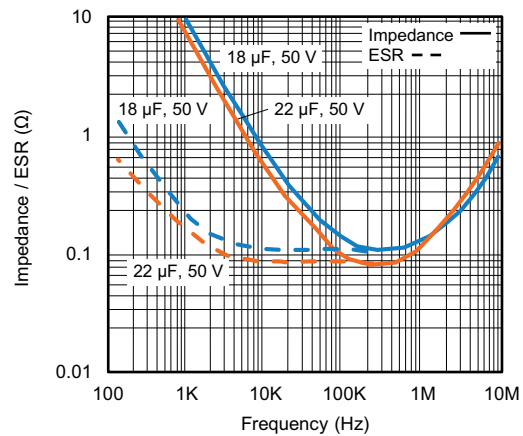
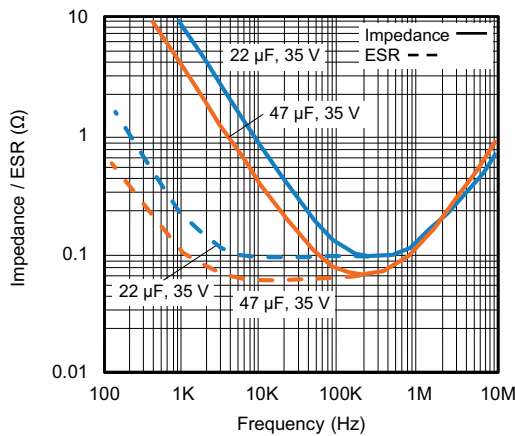
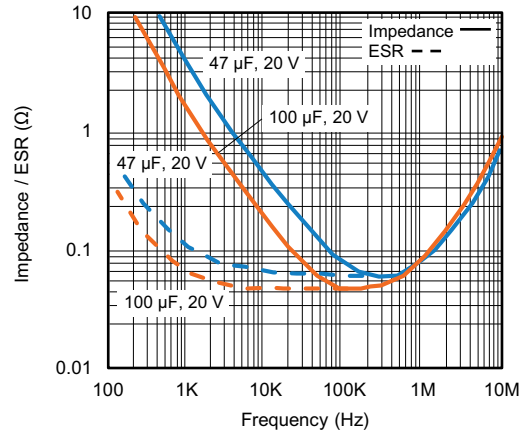
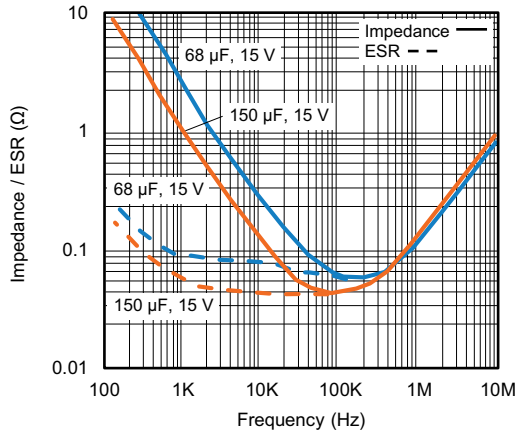
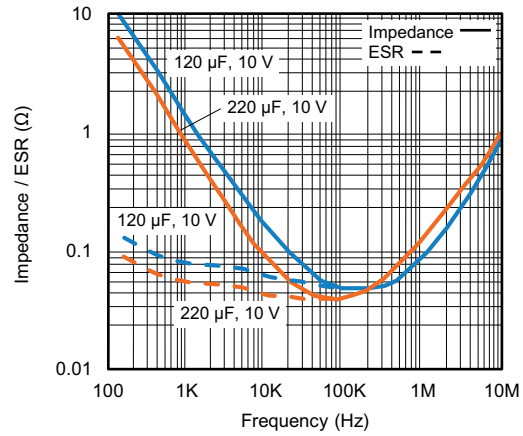
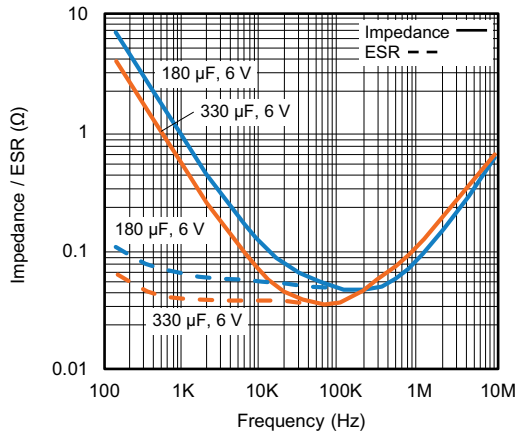



PERFORMANCE CHARACTERISTICS

1. Operating Temperature: capacitors are designed to operate over the temperature range of -55 °C to +85 °C with no derating.

1.1 Capacitors may be operated up to +125 °C with voltage derating to two-thirds the +85 °C rating.

| +85 °C RATING       |                   | +125 °C RATING      |                   |
|---------------------|-------------------|---------------------|-------------------|
| WORKING VOLTAGE (V) | SURGE VOLTAGE (V) | WORKING VOLTAGE (V) | SURGE VOLTAGE (V) |
| 6                   | 8                 | 4                   | 5                 |
| 10                  | 13                | 7                   | 9                 |
| 15                  | 20                | 10                  | 12                |
| 20                  | 26                | 13                  | 16                |
| 35                  | 46                | 23                  | 28                |
| 50                  | 65                | 33                  | 40                |

2. DC Working Voltage: the DC working voltage is the maximum operating voltage for continuous duty at the rated temperature.

3. Surge Voltage: the surge DC rating is the maximum voltage to which the capacitors may be subjected under any conditions, including transients and peak ripple at the highest line voltage.

3.1 Surge Voltage Test: capacitors shall withstand the surge voltage applied in series with a 33 Ω ± 5 % resistor at the rate of 1.5 min on, 1.5 min off at +85 °C, for 1000 successive test cycles.

3.2 Following the surge voltage test, the dissipation factor and the leakage current shall meet the initial requirements; the capacitance shall not have changed more than ± 10 %.

4. Capacitance Tolerance: the capacitance of all capacitors shall be within the specified tolerance limits of the nominal rating.

4.1 Capacitance measurements shall be made by means of polarized capacitance bridge. The polarizing voltage shall be of such magnitude that there shall be no reversal of polarity due to the AC component. The maximum voltage applied to capacitors during measurement shall be 2 VRMS at 1000 Hz at +25 °C. If the AC voltage applied is less than 0.5 VRMS, no DC bias is required. Measurement accuracy of the bridge shall be within ± 2 %.

5. Capacitance Change with Temperature: the capacitance change with temperature shall not exceed the following percentage of the capacitance measured at +25 %

| -55 °C | +85 °C | +125 °C |
|--------|--------|---------|
| -10 %  | +8 %   | +12 %   |

6. Dissipation Factor: the dissipation factor, determined from the expression 2πfCR, shall not exceed values listed in the Standard Ratings table.

6.1 Measurements shall be made by the bridge method at, or referred to, a frequency of 1000 Hz and a temperature of +25 °C.

7. Leakage Current: capacitors shall be stabilized at the rated temperature for 30 min. Rated voltage shall be applied to capacitors for 5 min using a steady source of power (such as a regulated power supply) with 1000 Ω resistor connected in series with the capacitor under test to limit the charging current. Leakage current shall then be measured.

Note that the leakage current varies with temperature and applied voltage. See graph below for the appropriate adjustment factor.

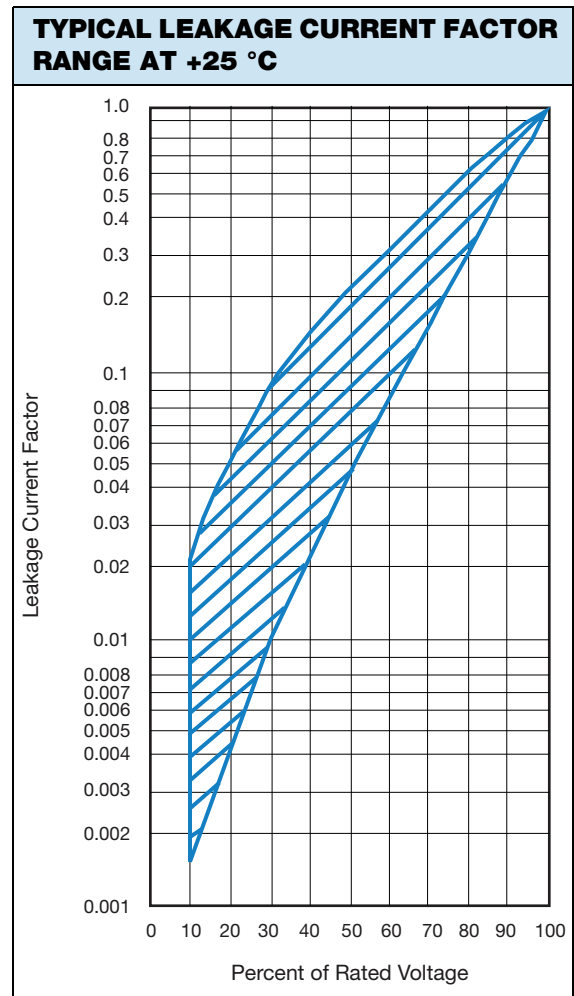

**PERFORMANCE CHARACTERISTICS** (Continued)

- 7.1 **At +25 °C**, the leakage current shall not exceed the value listed in the Standard Ratings table.
- 7.2 **At +85 °C**, the leakage current shall not exceed 10 times the value listed in the Standard Ratings table.
- 7.3 **At +125 °C**, the leakage current shall not exceed 15 times the value listed in the Standard Ratings table.
8. **Life Test:** capacitors shall withstand rated DC voltage applied at +85 °C for 2000 h or rated DC voltage applied at +125 °C for 1000 h.
- 8.1 Following the life test, the dissipation factor shall meet the initial requirement; the capacitance change shall not exceed  $\pm 2\%$ ; the leakage current shall not exceed 125 % of the original requirement.
9. **Shelf Test:** capacitors shall withstand a shelf test for 5000 h at a temperature of +85 °C, with no voltage applied.
- 9.1 Following the shelf test, the leakage current shall meet the initial requirement; the dissipation factor shall not exceed 150 % of the initial requirement; the capacitance change shall not exceed  $\pm 5\%$ .
10. **Vibration Tests:** capacitors shall be subjected to vibration tests in accordance with the following criteria.
- 10.1 Capacitors shall be secured for test by means of a rigid mounting using suitable brackets.
- 10.2 Low Frequency Vibration: vibration shall consist of a simple harmonic motion having an amplitude of 0.03" [0.76] and a maximum total excursion of 0.06" [1.52], in a direction perpendicular to the major axis of the capacitor.
- 10.2.1 Vibration frequency shall be varied uniformly between the approximate limits of 10 Hz to 55 Hz during a period of approximately one minute, continuously for 1 h and 1.5 h.
- 10.2.2 A cathode ray oscilloscope or other comparable means shall be used in determining electrical intermittency during the final 30 minutes of the test. The AC voltage applied shall not exceed  $2 V_{RMS}$ .
- 10.2.3 Electrical tests shall show no evidence of intermittent contacts, open circuits or short circuits during these tests.
- 10.2.4 Following the low frequency vibration test, capacitors shall meet the original requirements for leakage current and dissipation factor; capacitance change shall not exceed  $\pm 5\%$  of the original measured value.
- 10.3 **High Frequency Vibration:** vibration shall consist of a simple harmonic motion having an amplitude of 0.06" [1.52]  $\pm 10\%$  maximum total excursion or 20 g peak, whichever is less.
- 10.3.1 Vibration frequency shall be varied logarithmically from 50 Hz to 2000 Hz and return to 50 Hz during a cycle period of 20 min.
- 10.3.2 The vibration shall be applied for 4 h in each of 2 directions, parallel and perpendicular to the major axis of the capacitors.
- 10.3.3 Rated DC voltage shall be applied during the vibration cycling.
- 10.3.4 A cathode ray oscilloscope or other comparable means shall be used in determining electrical intermittency during test. The AC voltage applied shall not exceed  $2 V_{RMS}$ .
- 10.3.5 Electrical tests shall show no evidence of intermittent contacts, open circuits or short circuits during these tests.
- 10.3.6 There shall be no mechanical damage to these capacitors as a result of these tests.
- 10.3.7 Following the high frequency vibration test, capacitors shall meet the original limits for capacitance, dissipation factor and leakage current.
11. **Acceleration Test:**
- 11.1 Capacitors shall be rigidly mounted by means of suitable brackets.
- 11.2 Capacitors shall be subjected to a constant acceleration of 100 g for a period of 10 s in each of 2 mutually perpendicular planes.
- 11.2.1 The direction of motion shall be parallel to and perpendicular to the cylindrical axis of the capacitors.
- 11.3 Rated DC voltage shall be applied during acceleration test.
- 11.3.1 A cathode ray oscilloscope or other comparable means shall be used in determining electrical intermittency during test. The AC voltage applied shall not exceed  $2 V_{RMS}$ .
- 11.4 Electrical tests shall show no evidence of intermittent contacts, open circuits or short circuits during these tests.
- 11.5 There shall be no mechanical damage to these capacitors as a result of these tests.
- 11.6 Following the acceleration test, capacitors shall meet the original limits for capacitance, dissipation factor and leakage current.
12. **Shock Test:**
- 12.1 Capacitors shall be rigidly mounted by means of suitable brackets. The test load shall be distributed uniformly on the test platform to minimize the effects of unbalanced loads.
- 12.1.1 Test equipment shall be adjusted to produce a shock of 100 g peak with a duration of 6 ms and a sawtooth waveform at a velocity change of 9.7 ft./s.
- 12.2 Capacitors shall be subjected to 3 shocks applied in each of 3 directions corresponding to the 3 mutually perpendicular axes of the capacitors.
- 12.3 Rated DC voltage shall be applied to capacitors during test.
- 12.3.1 A cathode ray oscilloscope or other comparable means shall be used in determining electrical intermittency during test. The AC voltage applied shall not exceed  $2 V_{RMS}$ .
- 12.4 Electrical tests shall show no evidence of intermittent contacts, open circuits or short circuits during these tests.
- 12.5 There shall be no mechanical damage to these capacitors as a result of these tests.
- 12.6 Following the shock test, capacitors shall meet the original limits for capacitance, dissipation factor and leakage current.

**PERFORMANCE CHARACTERISTICS (Continued)**

- 13. Moisture Resistance:**
- 13.1 Capacitors shall be subjected to temperature cycling at 90 % to 98 % relative humidity, in a test chamber constructed of non-reactive materials (non-resiniferous and containing no formaldehyde or phenol). Steam or distilled, demineralized or deionized water having a pH value between 6.0 and 7.2 at +23 °C shall be used to obtain the required humidity. No rust, corrosive contaminants or dripping condensate shall be imposed on test specimens.
- 13.1.1 Capacitors shall be mounted by their normal mounting means in a normal mounting position and placed in a test chamber so that uniform and thorough exposure is obtained.
- 13.1.2 No conditioning or initial measurements will be performed prior to temperature cycling. Polarization and load voltages are not applicable.
- 13.1.3 Capacitors shall be subjected to temperature cycling from +25 °C to +65 °C to +25 °C (+ 10 °C, - 2 °C) over a period of 8 h, at 90 % to 98 % relative humidity, for 20 cycles.
- 13.1.4 Temperature cycling shall be stopped after an even number of cycles 5 times during the first 18 cycles, and the capacitor shall be allowed to stabilize at high humidity for 1 h to 4 h.
- 13.1.5 After stabilization, capacitors shall be removed from the humidity chamber and shall be conditioned for 3 h at - 10 °C ± 2 °C.
- 13.1.6 After cold conditioning, capacitors shall be subjected to vibration cycling consisting of a simple harmonic vibration having an amplitude of 0.03" [0.76] and a maximum total excursion of 0.06" [1.52] varied uniformly from 10 Hz to 55 Hz to 10 Hz over a period of 1 min, for 15 cycles.
- 13.1.7 Capacitors shall then be returned to temperature/humidity cycling.
- 13.2 After completion of temperature cycling, capacitors shall be removed from the test chamber and stabilized at room temperature for 2 h to 6 h.
- 13.3 Capacitors shall show no evidence of harmful or extensive corrosion, obliteration or marking or other visible damage.
- 13.4 Following the moisture resistance test, capacitors shall meet the original limits for capacitance, dissipation factor and leakage current.
- 14. Insulating Sleeves:**
- 14.1 Capacitors with insulating sleeves shall withstand a 2000 V<sub>DC</sub> potential applied for 1 min between the case and a metal "V" block in intimate contact with the insulating sleeve.
- 14.2 Capacitors with insulating sleeves shall have the insulation resistance measured between the case and a metal "V" block in intimate contact with the insulating sleeve. The insulation resistance shall be at least 1000 MΩ.
- 15. Thermal Shock And Immersion Cycling:**
- 15.1 Capacitors shall be conditioned prior to temperature cycling for 15 min at +25 °C, at less than 50 % relative humidity and a barometric pressure at 28" to 31".
- 15.2 Capacitors shall be subjected to thermal shock in a cycle of exposure to ambient air at -65 °C (+ 0 °C, - 5 °C) for 30 min, then, +25 °C (+ 10 °C, - 5 °C) for 5 min, then +125 °C (+ 3 °C, - 0 °C) for 30 min, then +25 °C (+ 10 °C, - 5 °C) for 5 min, for 5 cycles.
- 15.3 Between 4 h and 24 h after temperature cycling, capacitors shall be subjected to immersion in a bath of fresh tap water with the non-corrosive dye Rhodamine B added, at +65 °C (+ 5 °C, - 0 °C) for 15 min, then, within 3 s, immersed in a saturated solution of sodium chloride and water with Rhodamine B added, at a temperature of +25 °C (+10 °C, -5 °C) for 15 min, for 2 cycles.
- 15.3.1 Capacitors shall be thoroughly rinsed and wiped or air-blasted dry immediately upon removal from immersion cycling.
- 15.4 Capacitors shall show no evidence of harmful or extensive corrosion, obliteration of marking or other visible damage.
- 15.5 Following the thermal shock immersion cycling test, capacitors shall meet the original requirements for leakage current and dissipation factor; capacitance change shall not exceed ± 5 % of the original measured value.
- 15.6 Capacitors shall be opened and examined. There shall be no evidence of dye penetration.
- 16. Reduced Pressure Test:**
- 16.1 Capacitors shall be stabilized at a reduced pressure of 0.315" [8.0] of mercury, equivalent to an altitude of 100 000 feet [30.480 m], for a period of 5 min.
- 16.2 Rated DC voltage shall be applied for 1 min.
- 16.3 Capacitors shall not flash over nor shall end seals be damaged.
- 16.4 Following the reduced pressure test, the capacitance, equivalent series resistance and leakage current shall meet the original requirements.
- 17. Lead Pull Test:** leads shall withstand a tensile stress of 3 pounds (1.4 kg) applied in any direction for 30 s.
- 18. Marking:** marking on metal case of hermetically sealed capacitors shows: series name, capacitance value in microfarads, capacitance tolerance, rated voltage in volts, date code (four digit: YYWW), Vishay marking (circled two), polarity signs (pluses).
- 18.1 For lead (Pb)-free capacitors capital letter L is added after date code. There is slight variation between different case sizes.
- 18.2 Vishay Sprague reserves the right to furnish capacitors of higher working voltages than those ordered, where the physical size of the higher voltage units is identical to that of the units ordered.



GUIDE TO APPLICATION

- 1. **AC Ripple Current:** the maximum allowable ripple current shall be determined from the formula:

$$I_{RMS} = \sqrt{\frac{P}{R_{ESR}}}$$

where,

P = power dissipation in W at +25 °C as given in the table in paragraph number 5 (Power Dissipation)

R<sub>ESR</sub> = the capacitor equivalent series resistance at the specified frequency

- 2. **AC Ripple Voltage:** the maximum allowable ripple voltage shall be determined from the formula:

$$V_{RMS} = Z \sqrt{\frac{P}{R_{ESR}}}$$

or, from the formula:

$$V_{RMS} = I_{RMS} \times Z$$

where,

P = power dissipation in W at +25 °C as given in the table in paragraph number 5 (Power Dissipation).

R<sub>ESR</sub> = the capacitor equivalent series resistance at the specified frequency.

Z = the capacitor Impedance at the specified frequency.

- 2.1 The sum of the peak AC voltage plus the DC voltage shall not exceed the DC voltage rating of the capacitor.
- 2.2 The sum of the negative peak AC voltage plus the applied DC voltage shall not allow a voltage reversal exceeding 15 % of the DC working voltage at +25 °C.
- 3. **Reverse Voltage:** these capacitors are capable of withstanding peak voltages in the reverse direction equal to 15 % of the DC rating at +25 °C, 10 % of the DC rating at +55 °C; 5 % of the DC rating at +85 °C.
- 4. **Temperature Derating:** if these capacitors are to be operated at temperatures above +25 °C, the permissible RMS ripple current or voltage shall be calculated using the derating factors as shown:

| TEMPERATURE | DERATING FACTOR |
|-------------|-----------------|
| +25 °C      | 1.0             |
| +55 °C      | 0.8             |
| +85 °C      | 0.6             |
| +125 °C     | 0.4             |

- 5. **Power Dissipation:** the figures shown relate to an approximate +20 °C rise in case temperature measured in free air. Power dissipation will be affected by the heat sinking capability of the mounting surface. Non-sinusoidal ripple current may produce heating effects which differ from those shown. It is important that the equivalent I<sub>RMS</sub> value be established when calculating permissible operating levels.

| CASE CODE | POWER DISSIPATION AT +25 °C (W) |
|-----------|---------------------------------|
| A         | 0.115                           |
| B         | 0.145                           |
| R         | 0.185                           |
| S         | 0.225                           |



## Disclaimer

ALL PRODUCT, PRODUCT SPECIFICATIONS AND DATA ARE SUBJECT TO CHANGE WITHOUT NOTICE TO IMPROVE RELIABILITY, FUNCTION OR DESIGN OR OTHERWISE.

Vishay Intertechnology, Inc., its affiliates, agents, and employees, and all persons acting on its or their behalf (collectively, "Vishay"), disclaim any and all liability for any errors, inaccuracies or incompleteness contained in any datasheet or in any other disclosure relating to any product.

Vishay makes no warranty, representation or guarantee regarding the suitability of the products for any particular purpose or the continuing production of any product. To the maximum extent permitted by applicable law, Vishay disclaims (i) any and all liability arising out of the application or use of any product, (ii) any and all liability, including without limitation special, consequential or incidental damages, and (iii) any and all implied warranties, including warranties of fitness for particular purpose, non-infringement and merchantability.

Statements regarding the suitability of products for certain types of applications are based on Vishay's knowledge of typical requirements that are often placed on Vishay products in generic applications. Such statements are not binding statements about the suitability of products for a particular application. It is the customer's responsibility to validate that a particular product with the properties described in the product specification is suitable for use in a particular application. Parameters provided in datasheets and / or specifications may vary in different applications and performance may vary over time. All operating parameters, including typical parameters, must be validated for each customer application by the customer's technical experts. Product specifications do not expand or otherwise modify Vishay's terms and conditions of purchase, including but not limited to the warranty expressed therein.

Hyperlinks included in this datasheet may direct users to third-party websites. These links are provided as a convenience and for informational purposes only. Inclusion of these hyperlinks does not constitute an endorsement or an approval by Vishay of any of the products, services or opinions of the corporation, organization or individual associated with the third-party website. Vishay disclaims any and all liability and bears no responsibility for the accuracy, legality or content of the third-party website or for that of subsequent links.

Except as expressly indicated in writing, Vishay products are not designed for use in medical, life-saving, or life-sustaining applications or for any other application in which the failure of the Vishay product could result in personal injury or death. Customers using or selling Vishay products not expressly indicated for use in such applications do so at their own risk. Please contact authorized Vishay personnel to obtain written terms and conditions regarding products designed for such applications.

No license, express or implied, by estoppel or otherwise, to any intellectual property rights is granted by this document or by any conduct of Vishay. Product names and markings noted herein may be trademarks of their respective owners.