

# Surface-Mount PAR<sup>®</sup> Transient Voltage Suppressors

High Temperature Stability and High Reliability Conditions

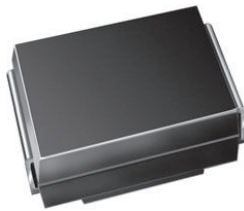

**SMB (DO-214AA)**

Cathode  Anode

## LINKS TO ADDITIONAL RESOURCES



PRIMARY CHARACTERISTICS	
$V_{BR}$	6.8 V to 43 V
$V_{WM}$	5.8 V to 36.8 V
$P_{PPM}$	600 W
$I_{FSM}$	75 A
$T_J$ max.	185 °C
Polarity	Unidirectional
Package	SMB (DO-214AA)

## TYPICAL APPLICATIONS

Use in sensitive electronics protection against voltage transients induced by inductive load switching and lighting on ICs, MOSFET, signal lines of sensor units for consumer, computer, industrial, automotive, and telecommunication.

## FEATURES

- Junction passivation optimized design passivated anisotropic rectifier technology
- $T_J = 185$  °C capability suitable for high reliability and automotive requirement
- Available in unidirectional polarity only
- 600 W peak pulse power capability with a 10/1000  $\mu$ s waveform, repetitive rate (duty cycle): 0.01 %
- Excellent clamping capability
- Very fast response time
- Low incremental surge resistance
- Meets MSL level 1, per J-STD-020, LF maximum peak of 260 °C
- AEC-Q101 qualified available  
- Automotive ordering code: base P/NHE3 or P/NHM3
- Material categorization: for definitions of compliance please see [www.vishay.com/doc?99912](http://www.vishay.com/doc?99912)



## MECHANICAL DATA

**Case:** SMB (DO-214AA)

Molding compound meets UL 94 V-0 flammability rating  
Base P/NHE3\_X - RoHS-compliant and AEC-Q101 qualified  
Base P/NHM3\_X - halogen-free, RoHS-compliant, and AEC-Q101 qualified  
("X" denotes revision code e.g. A, B, ...)

**Terminals:** matte tin plated leads, solderable per J-STD-002 and JESD 22-B102

HE3 and HM3 suffix meets JESD 201 class 2 whisker test

**Polarity:** color band denotes cathode end

## MAXIMUM RATINGS ( $T_A = 25$ °C, unless otherwise noted)

PARAMETER	SYMBOL	VALUE	UNIT
Peak pulse power dissipation with a 10/1000 $\mu$ s waveform (fig. 1) <sup>(1)(2)</sup>	$P_{PPM}$	600	W
Peak pulse current with a 10/1000 $\mu$ s waveform (fig. 3) <sup>(1)</sup>	$I_{PPM}$	See table next page	A
Peak forward surge current 8.3 ms single half sine-wave <sup>(2)(3)</sup>	$I_{FSM}$	75	A
Maximum instantaneous forward voltage at 50 A <sup>(2)(3)</sup>	$V_F$	3.5	V
Operating junction and storage temperature range	$T_J, T_{STG}$	-65 to +185	°C

### Notes

<sup>(1)</sup> Non-repetitive current pulse, per fig. 3 and derated above  $T_A = 25$  °C per fig. 2

<sup>(2)</sup> Mounted on 0.2" x 0.2" (5.0 mm x 5.0 mm) copper pads at each terminal

<sup>(3)</sup> Measured on 8.3 ms single half sine-wave, or equivalent square wave, duty cycle = 4 pulses per minute maximum



ELECTRICAL CHARACTERISTICS (T <sub>A</sub> = 25 °C, unless otherwise noted)											
DEVICE TYPE	DEVICE MARKING CODE	BREAKDOWN VOLTAGE V <sub>BR</sub> <sup>(1)</sup> AT I <sub>T</sub> (V)			TEST CURRENT I <sub>T</sub> (mA)	STAND-OFF VOLTAGE V <sub>WM</sub> (V)	MAXIMUM REVERSE LEAKAGE AT V <sub>WM</sub> I <sub>R</sub> (μA)	MAXIMUM REVERSE LEAKAGE AT V <sub>WM</sub> T <sub>J</sub> = 150 °C I <sub>D</sub> (μA)	MAXIMUM PEAK PULSE SURGE CURRENT I <sub>PPM</sub> <sup>(2)</sup> (A)	MAXIMUM CLAMPING VOLTAGE AT I <sub>PPM</sub> V <sub>C</sub> (V)	TYPICAL TEMP. COEFFICIENT OF V <sub>BR</sub> <sup>(3)</sup> α <sub>T</sub> (%/°C)
		MIN.	NOM.	MAX.							
TPSMB6.8A	KEP	6.45	6.80	7.14	10	5.8	500	1000	57.1	10.5	0.047
TPSMB7.5A	KGP	7.13	7.50	7.88	10	6.4	250	500	53.1	11.3	0.052
TPSMB8.2A	KKP	7.79	8.20	8.61	10	7.02	100	200	49.6	12.1	0.056
TPSMB9.1A	KMP	8.65	9.10	9.55	1	7.78	25	50	44.8	13.4	0.060
TPSMB10A	KPP	9.5	10.0	10.5	1	8.55	5	20	41.4	14.5	0.064
TPSMB11A	KRP	10.5	11.0	11.6	1	9.4	2	5	38.5	15.6	0.067
TPSMB12A	KTP	11.4	12.0	12.6	1	10.2	2	5	35.9	16.7	0.070
TPSMB13A	KVP	12.4	13.0	13.7	1	11.1	2	5	33	18.2	0.072
TPSMB15A	KXP	14.3	15.0	15.8	1	12.8	1	5	28.3	21.2	0.076
TPSMB16A	KZP	15.2	16.0	16.8	1	13.6	1	5	26.7	22.5	0.078
TPSMB18A	LEP	17.1	18.0	18.9	1	15.3	1	5	23.8	25.2	0.080
TPSMB20A	LGP	19	20.0	21	1	17.1	1	5	21.7	27.7	0.082
TPSMB22A	LKP	20.9	22.0	23.1	1	18.8	1	5	19.6	30.6	0.084
TPSMB24A	LMP	22.8	24.0	25.2	1	20.5	1	5	18.1	33.2	0.085
TPSMB27A	LPP	25.7	27.0	28.4	1	23.1	1	5	16	37.5	0.087
TPSMB30A	LRP	28.5	30.0	31.5	1	25.6	1	5	14.5	41.4	0.088
TPSMB33A	LTP	31.4	33.0	34.7	1	28.2	1	5	13.1	45.7	0.089
TPSMB36A	LVP	34.2	36.0	37.8	1	30.8	1	5	12	49.9	0.090
TPSMB39A	LXP	37.1	39.0	41.0	1	33.3	1	5	11.1	53.9	0.091
TPSMB43A	LZP	40.9	43.0	45.2	1	36.8	1	5	10.1	59.3	0.092

**Notes**

- (1) V<sub>BR</sub> measured after I<sub>T</sub> applied for 300 μs, I<sub>T</sub> = square wave pulse or equivalent
- (2) Surge current waveform per fig. 3 and derated per fig. 2
- (3) To calculate V<sub>BR</sub> vs. junction temperature, use the following formula: V<sub>BR</sub> at T<sub>J</sub> = V<sub>BR</sub> at 25 °C x (1 + α<sub>T</sub> x (T<sub>J</sub> - 25))
- (4) All terms and symbols are consistent with ANSI/IEEE C62.35

ORDERING INFORMATION (Example)				
PREFERRED P/N	UNIT WEIGHT (g)	PREFERRED PACKAGE CODE	BASE QUANTITY	DELIVERY MODE
TPSMB6.8AHE3_A/H <sup>(1)</sup>	0.096	H	750	7" diameter plastic tape and reel
TPSMB6.8AHE3_A/I <sup>(1)</sup>	0.096	I	3200	13" diameter plastic tape and reel
TPSMB6.8AHM3_A/H <sup>(1)</sup>	0.096	H	750	7" diameter plastic tape and reel
TPSMB6.8AHM3_A/I <sup>(1)</sup>	0.096	I	3200	13" diameter plastic tape and reel

**Note**

- (1) AEC-Q101 qualified

## RATINGS AND CHARACTERISTICS CURVES (T<sub>A</sub> = 25 °C, unless otherwise noted)

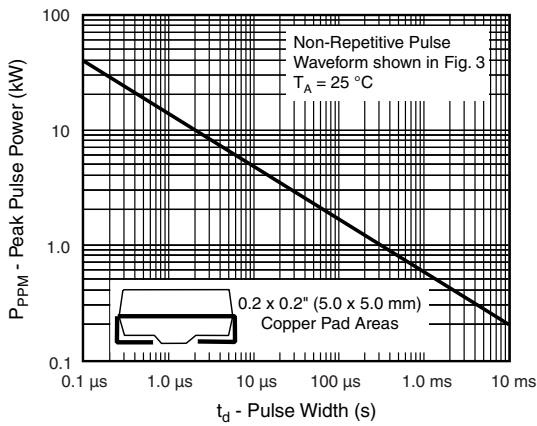

Fig. 1 - Peak Pulse Power Rating Curve

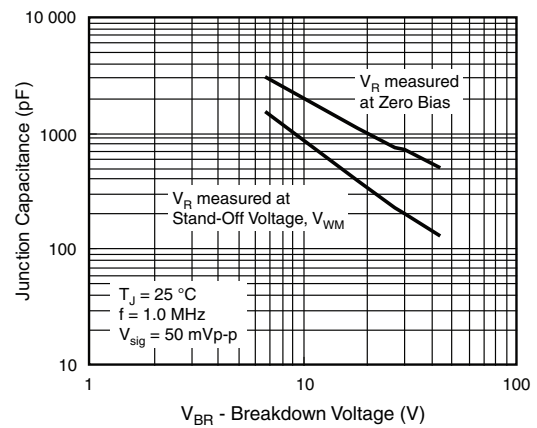

Fig. 4 - Typical Junction Capacitance

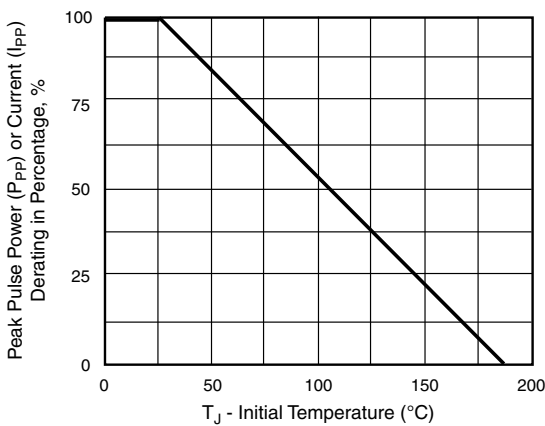

Fig. 2 - Pulse Power or Current vs. Initial Junction Temperature

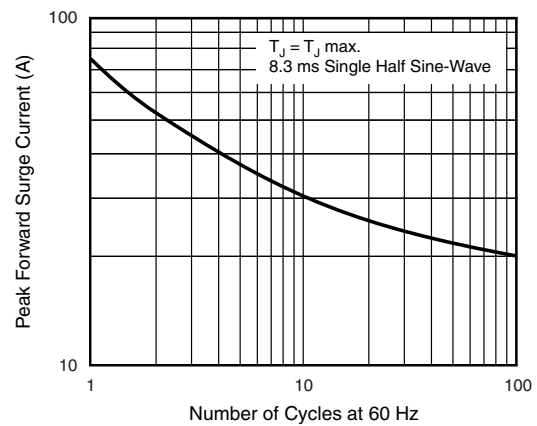

Fig. 5 - Maximum Non-Repetitive/Peak Forward Surge Current

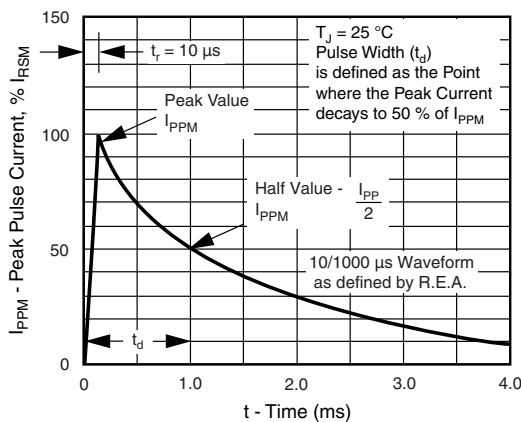
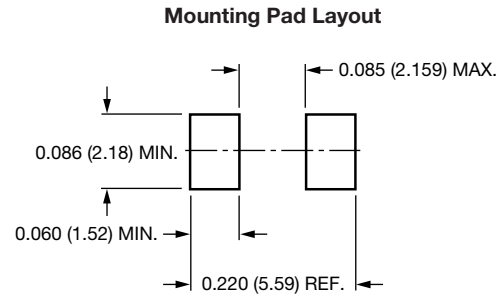
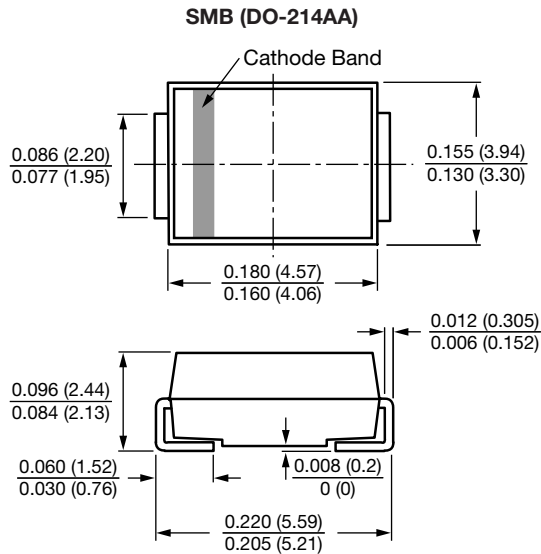

Fig. 3 - Pulse Waveform



## PACKAGE OUTLINE DIMENSIONS in inches (millimeters)





## Disclaimer

ALL PRODUCT, PRODUCT SPECIFICATIONS AND DATA ARE SUBJECT TO CHANGE WITHOUT NOTICE TO IMPROVE RELIABILITY, FUNCTION OR DESIGN OR OTHERWISE.

Vishay Intertechnology, Inc., its affiliates, agents, and employees, and all persons acting on its or their behalf (collectively, "Vishay"), disclaim any and all liability for any errors, inaccuracies or incompleteness contained in any datasheet or in any other disclosure relating to any product.

Vishay makes no warranty, representation or guarantee regarding the suitability of the products for any particular purpose or the continuing production of any product. To the maximum extent permitted by applicable law, Vishay disclaims (i) any and all liability arising out of the application or use of any product, (ii) any and all liability, including without limitation special, consequential or incidental damages, and (iii) any and all implied warranties, including warranties of fitness for particular purpose, non-infringement and merchantability.

Statements regarding the suitability of products for certain types of applications are based on Vishay's knowledge of typical requirements that are often placed on Vishay products in generic applications. Such statements are not binding statements about the suitability of products for a particular application. It is the customer's responsibility to validate that a particular product with the properties described in the product specification is suitable for use in a particular application. Parameters provided in datasheets and / or specifications may vary in different applications and performance may vary over time. All operating parameters, including typical parameters, must be validated for each customer application by the customer's technical experts. Product specifications do not expand or otherwise modify Vishay's terms and conditions of purchase, including but not limited to the warranty expressed therein.

Hyperlinks included in this datasheet may direct users to third-party websites. These links are provided as a convenience and for informational purposes only. Inclusion of these hyperlinks does not constitute an endorsement or an approval by Vishay of any of the products, services or opinions of the corporation, organization or individual associated with the third-party website. Vishay disclaims any and all liability and bears no responsibility for the accuracy, legality or content of the third-party website or for that of subsequent links.

Except as expressly indicated in writing, Vishay products are not designed for use in medical, life-saving, or life-sustaining applications or for any other application in which the failure of the Vishay product could result in personal injury or death. Customers using or selling Vishay products not expressly indicated for use in such applications do so at their own risk. Please contact authorized Vishay personnel to obtain written terms and conditions regarding products designed for such applications.

No license, express or implied, by estoppel or otherwise, to any intellectual property rights is granted by this document or by any conduct of Vishay. Product names and markings noted herein may be trademarks of their respective owners.