

FDS6675BZ

MOSFET – P-Channel, POWERTRENCH®

-30 V, -11 A, 13 mΩ

Description

This P-Channel MOSFET is produced using ON Semiconductor's advanced POWERTRENCH process that has been especially tailored to minimize the on-state resistance.

This device is well suited for Power Management and load switching applications common in Notebook Computers and Portable Battery Packs.

Features

- Max $R_{DS(on)}$ = 13 mΩ at $V_{GS} = -10$ V, $I_D = -11$ A
- Max $R_{DS(on)}$ = 21.8 mΩ at $V_{GS} = -4.5$ V, $I_D = -9$ A
- Extended V_{GS} Range (-25 V) for Battery Applications
- HBM ESD Protection Level of 5.4 kV Typical (Note 3)
- High Performance Trench Technology for Extremely Low $R_{DS(on)}$
- High Power and Current Handling Capability
- This Device is Pb-Free and RoHS Compliant

Specifications

MAXIMUM RATINGS ($T_A = 25^\circ\text{C}$ unless otherwise noted)

Symbol	Parameter	Ratings	Unit
V_{DS}	Drain to Source Voltage	-30	V
V_{GS}	Gate to Source Voltage	±25	V
I_D	Drain Current – Continuous (Note 1a) – Pulsed	-11 -55	A
P_D	Power Dissipation for Single Operation (Note 1a) (Note 1b) (Note 1c)	2.5 1.2 1.0	W
T_J, T_{STG}	Operating and Storage Junction Temperature Range	-55 to +150	°C

Stresses exceeding those listed in the Maximum Ratings table may damage the device. If any of these limits are exceeded, device functionality should not be assumed, damage may occur and reliability may be affected.

THERMAL CHARACTERISTICS

Symbol	Parameter	Ratings	Unit
$R_{\theta JC}$	Thermal Resistance, Junction to Case	25	°C/W
$R_{\theta JA}$	Thermal Resistance, Junction to Ambient (Note 1a)	50	



ON Semiconductor®

www.onsemi.com

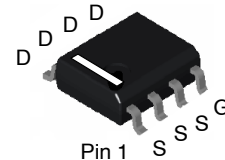

**SOIC8
CASE 751EB**

ELECTRICAL CONNECTION

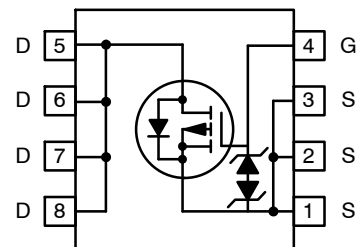

MARKING DIAGRAM

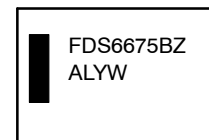

FDS4435BZ = Specific Device Code
A = Assembly Site
L = Wafer Lot Number
YW = Assembly Start Week

ORDERING INFORMATION

Device	Package	Shipping†
FDS6675BZ	SOIC8 (Pb-Free)	2,500 / Tape & Reel

†For information on tape and reel specifications, including part orientation and tape sizes, please refer to our Tape and Reel Packaging Specification Brochure, BRD8011/D.

FDS6675BZ

Table 1. ELECTRICAL CHARACTERISTICS ($T_A = 25^\circ\text{C}$)

Symbol	Parameter	Conditions	Min	Typ	Max	Unit
--------	-----------	------------	-----	-----	-----	------

OFF CHARACTERISTICS

BV_{DSS}	Drain to Source Breakdown Voltage	$I_D = -250 \mu\text{A}$, $V_{GS} = 0 \text{ V}$	-30			V
$\Delta BV_{DSS} / \Delta T_J$	Breakdown Voltage Temperature Coefficient	$I_D = -250 \mu\text{A}$, referenced to 25°C		-20		$\text{mV}/^\circ\text{C}$
I_{DSS}	Zero Gate Voltage Drain Current	$V_{DS} = -24 \text{ V}$, $V_{GS} = 0 \text{ V}$			-1	μA
I_{GSS}	Gate to Source Leakage Current	$V_{GS} = \pm 25 \text{ V}$, $V_{DS} = 0 \text{ V}$			± 10	μA

ON CHARACTERISTICS

$V_{GS(th)}$	Gate to Source Threshold Voltage	$V_{GS} = V_{DS}$, $I_D = -250 \mu\text{A}$	-1	-2	-3	V
$\Delta V_{GS(th)} / \Delta T_J$	Gate to Source Threshold Voltage Temperature Coefficient	$I_D = -250 \mu\text{A}$, referenced to 25°C		15.7		$\text{mV}/^\circ\text{C}$
$R_{DS(on)}$	Static Drain to Source On Resistance	$V_{GS} = -10 \text{ V}$, $I_D = -11 \text{ A}$		10.8	13.0	$\text{m}\Omega$
		$V_{GS} = -4.5 \text{ V}$, $I_D = -9 \text{ A}$		17.4	21.8	
		$V_{GS} = -10 \text{ V}$, $I_D = -11 \text{ A}$, $T_J = 125^\circ\text{C}$		15.0	18.8	
g_{FS}	Forward Transconductance	$V_{DS} = -5 \text{ V}$, $I_D = -11 \text{ A}$		34		S

DYNAMIC CHARACTERISTICS

C_{iss}	Input Capacitance	$V_{DS} = -15 \text{ V}$, $V_{GS} = 0 \text{ V}$, $f = 1 \text{ MHz}$		1855	2470	pF
C_{oss}	Output Capacitance			335	450	pF
C_{rss}	Reverse Transfer Capacitance			330	500	pF

SWITCHING CHARACTERISTICS

$t_{d(on)}$	Turn-On Delay Time	$V_{DD} = -15 \text{ V}$, $I_D = -11 \text{ A}$, $V_{GS} = -10 \text{ V}$, $R_{GS} = 6 \Omega$		3.0	10	ns
t_r	Rise Time			7.8	16	ns
$t_{d(off)}$	Turn-Off Delay Time			120	200	ns
t_f	Fall Time			60	100	ns
Q_g	Total Gate Charge	$V_{DS} = -15 \text{ V}$, $V_{GS} = -10 \text{ V}$, $I_D = -11 \text{ A}$		44	62	nC
Q_g	Total Gate Charge	$V_{DS} = -15 \text{ V}$, $V_{GS} = -5 \text{ V}$, $I_D = -11 \text{ A}$		25	35	nC
Q_{gs}	Gate to Source Charge			7.2		nC
Q_{gd}	Gate to Drain "Miller" Charge			11.4		nC

DRAIN-SOURCE DIODE CHARACTERISTICS

V_{SD}	Source to Drain Diode Forward Voltage	$V_{GS} = 0 \text{ V}$, $I_S = -2.1 \text{ A}$		-0.7	-1.2	V
t_{rr}	Reverse Recovery Time	$I_F = -11 \text{ A}$, $di/dt = 100 \text{ A}/\mu\text{s}$			42	ns
Q_{rr}	Reverse Recovery Charge	$I_F = -11 \text{ A}$, $di/dt = 100 \text{ A}/\mu\text{s}$			30	nC

Product parametric performance is indicated in the Electrical Characteristics for the listed test conditions, unless otherwise noted. Product performance may not be indicated by the Electrical Characteristics if operated under different conditions.

NOTES:

- $R_{\theta JA}$ is the sum of the junction-to-case and case-to-ambient thermal resistance where the case thermal reference is defined as the solder mounting surface of the drain pins. $R_{\theta JC}$ is guaranteed by design while $R_{\theta CA}$ is determined by the user's board design.

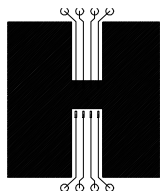

a. $50^\circ\text{C}/\text{W}$ when mounted on a 1 in^2 pad of 2 oz copper.

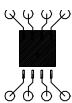

b. $105^\circ\text{C}/\text{W}$ when mounted on a 0.04 in^2 pad of 2 oz copper.

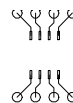

c. $125^\circ\text{C}/\text{W}$ when mounted on a minimum pad

- Pulse Test: Pulse Width $< 300 \mu\text{s}$, Duty cycle $< 2.0\%$.
- The diode connected between the gate and source serves only as protection against ESD. No gate overvoltage rating is implied.

TYPICAL CHARACTERISTICS

($T_J = 25^\circ\text{C}$ unless otherwise noted)

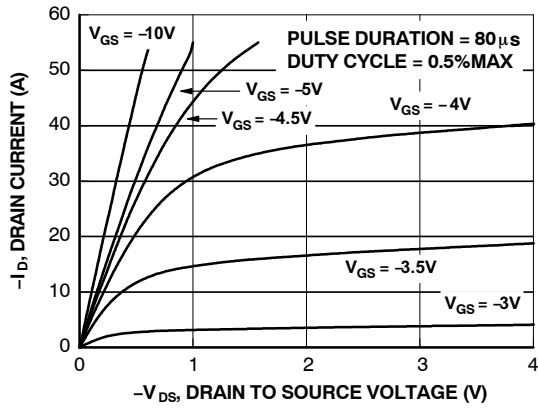

Figure 1. On-Region Characteristics

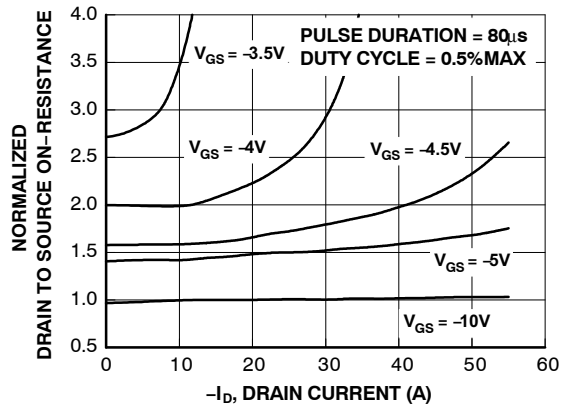

Figure 2. Normalized On-Resistance vs Drain Current and Gate Voltage

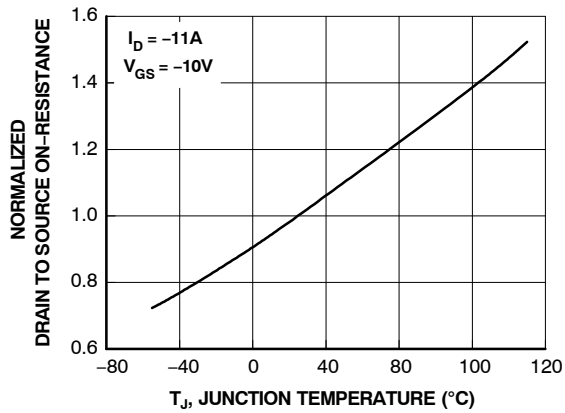

Figure 3. Normalized On-Resistance vs Junction Temperature

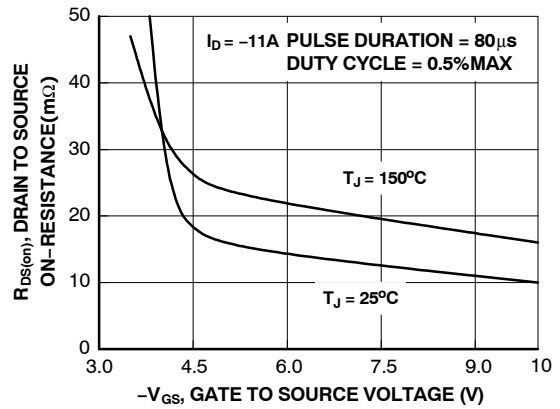

Figure 4. On-Resistance vs Gate to Source Voltage

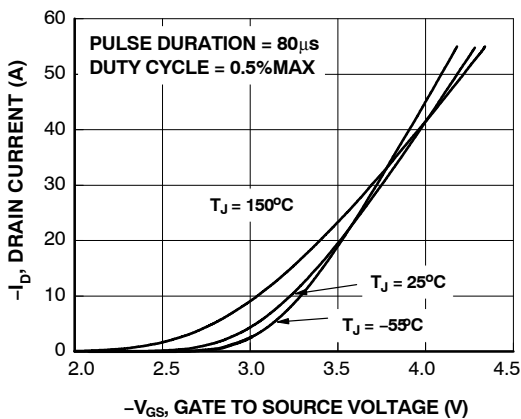

Figure 5. Transfer Characteristics

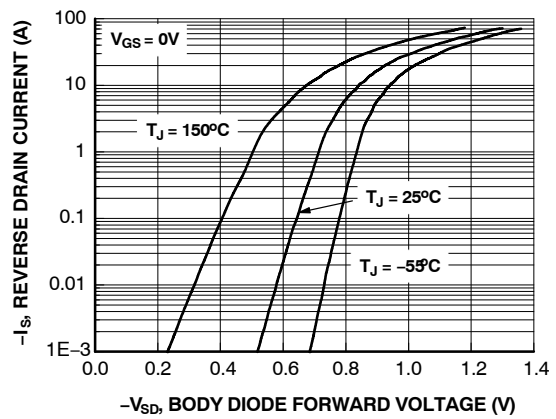

Figure 6. Source to Drain Diode Forward Voltage vs Source Current

FDS6675BZ

TYPICAL CHARACTERISTICS (Continued)

($T_J = 25^\circ\text{C}$ unless otherwise noted)

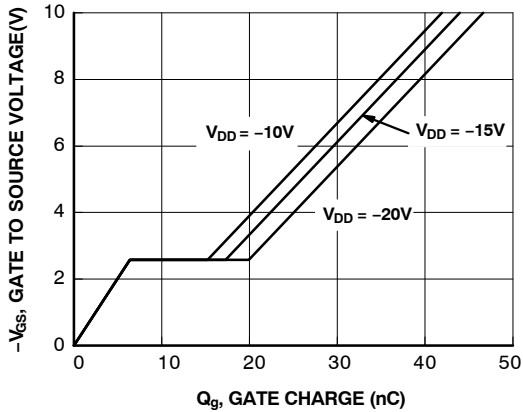

Figure 7. Gate Charge Characteristics

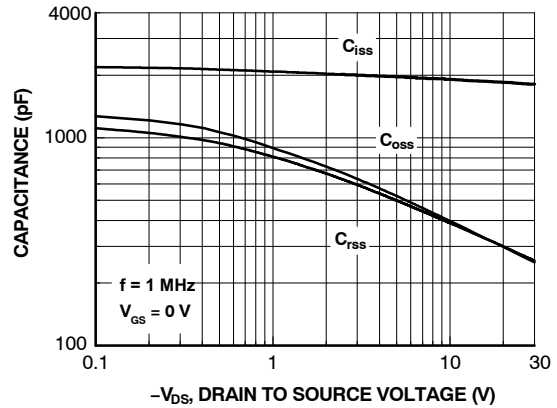

Figure 8. Capacitance vs Drain to Source Voltage

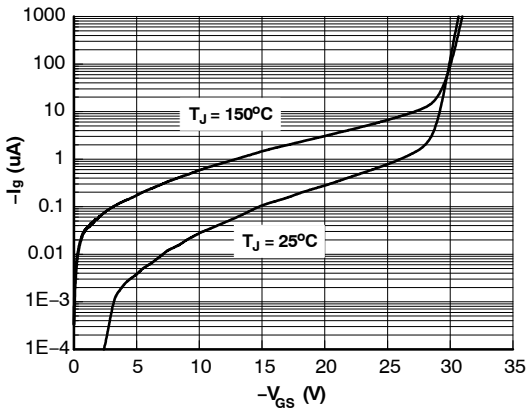

Figure 9. I_g vs V_{GS}

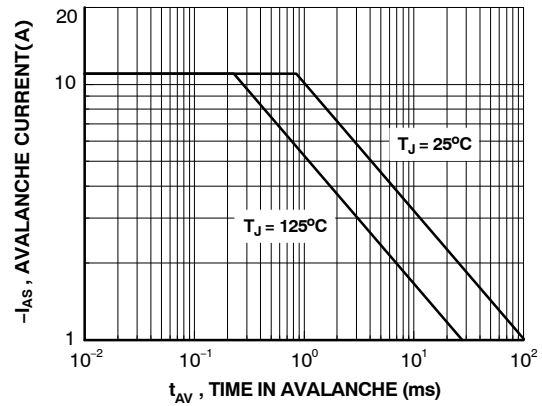

Figure 10. Unclamped Inductive Switching Capability

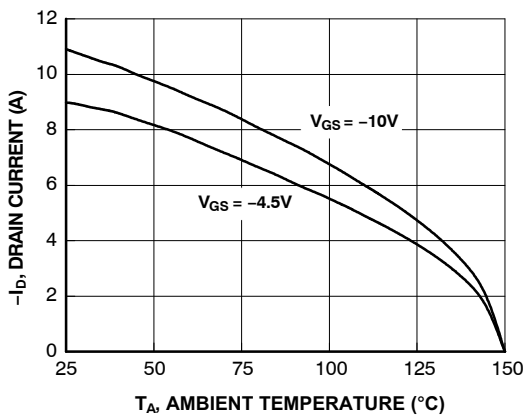

Figure 11. Maximum Continuous Drain Current vs Ambient Temperature

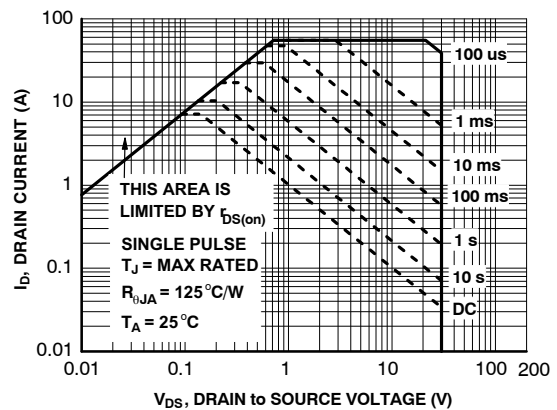

Figure 12. Forward Bias Safe Operating Area

FDS6675BZ

TYPICAL CHARACTERISTICS (Continued)

($T_J = 25^\circ\text{C}$ unless otherwise noted)

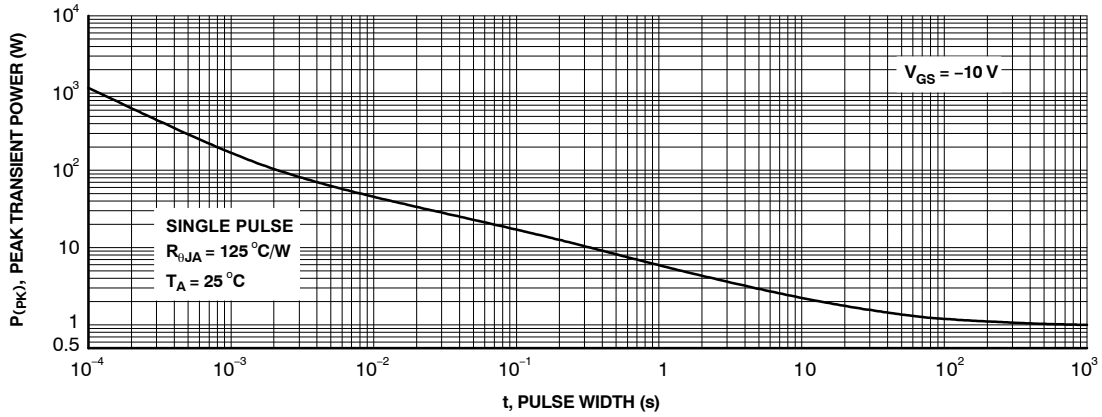

Figure 13. Single Pulse Maximum Power Dissipation

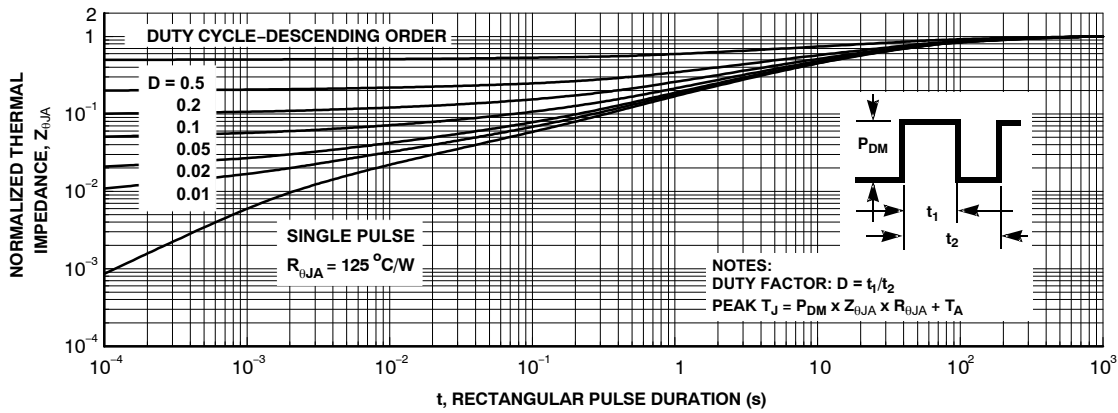

Figure 14. Junction To Ambient Transient Thermal Response Curve

POWERTRENCH is registered trademark of Semiconductor Components Industries, LLC (SCILLC) or its subsidiaries in the United States and/or other countries.

MECHANICAL CASE OUTLINE
PACKAGE DIMENSIONS

ON Semiconductor®



SOIC8
CASE 751EB
ISSUE A

DATE 24 AUG 2017

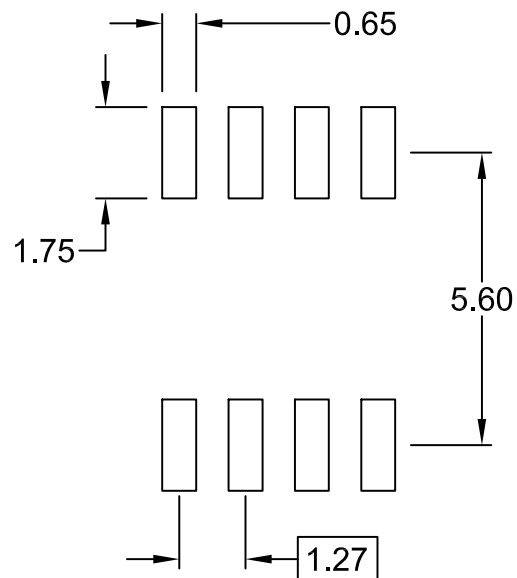
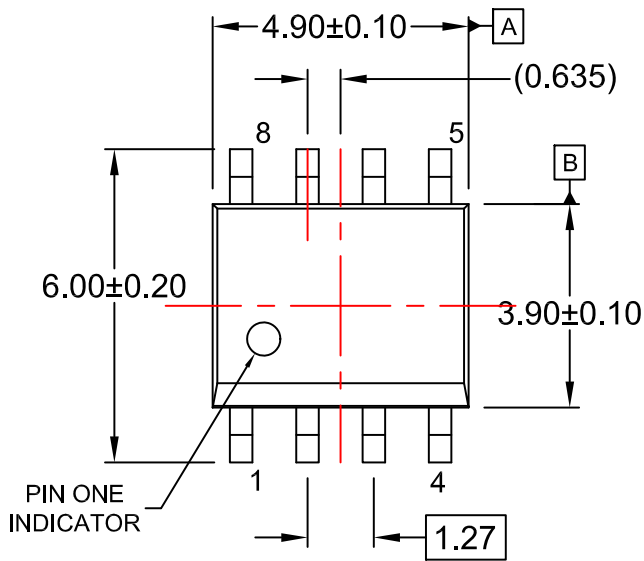

⊕ 0.25 (M) C B A

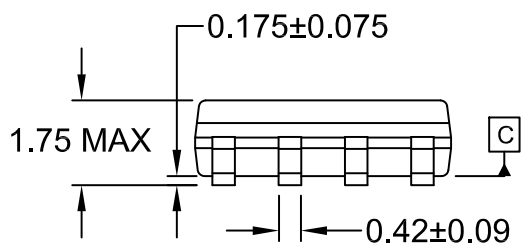

⌒ 0.10

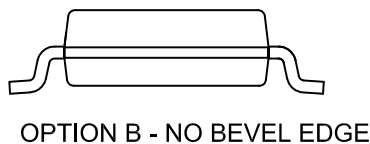
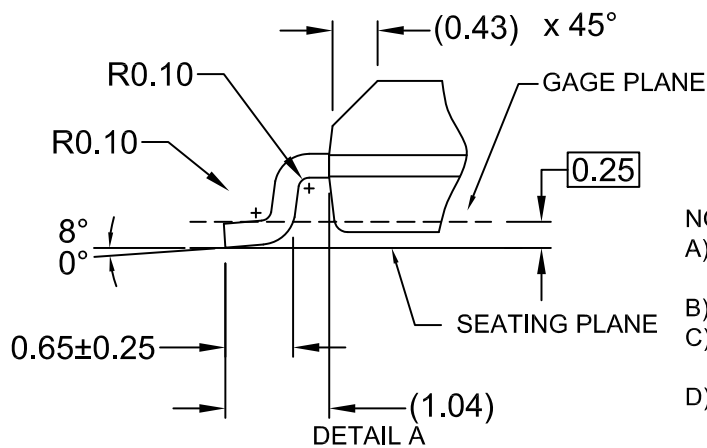
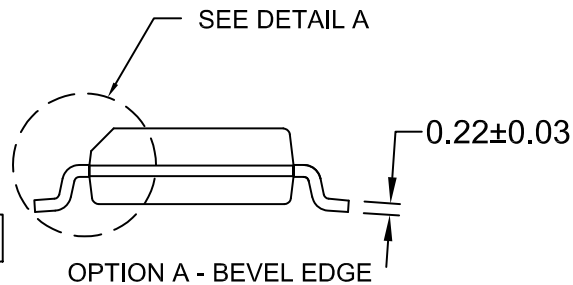

NOTES:

- A) THIS PACKAGE CONFORMS TO JEDEC MS-012, VARIATION AA.
- B) ALL DIMENSIONS ARE IN MILLIMETERS.
- C) DIMENSIONS DO NOT INCLUDE MOLD FLASH OR BURRS.
- D) LANDPATTERN STANDARD: SOIC127P600X175-8M

DOCUMENT NUMBER:	98AON13735G	Electronic versions are uncontrolled except when accessed directly from the Document Repository. Printed versions are uncontrolled except when stamped "CONTROLLED COPY" in red.
DESCRIPTION:	SOIC8	PAGE 1 OF 1

ON Semiconductor and are trademarks of Semiconductor Components Industries, LLC dba ON Semiconductor or its subsidiaries in the United States and/or other countries. ON Semiconductor reserves the right to make changes without further notice to any products herein. ON Semiconductor makes no warranty, representation or guarantee regarding the suitability of its products for any particular purpose, nor does ON Semiconductor assume any liability arising out of the application or use of any product or circuit, and specifically disclaims any and all liability, including without limitation special, consequential or incidental damages. ON Semiconductor does not convey any license under its patent rights nor the rights of others.

onsemi, **Onsemi**, and other names, marks, and brands are registered and/or common law trademarks of Semiconductor Components Industries, LLC dba "**onsemi**" or its affiliates and/or subsidiaries in the United States and/or other countries. **onsemi** owns the rights to a number of patents, trademarks, copyrights, trade secrets, and other intellectual property. A listing of **onsemi**'s product/patent coverage may be accessed at www.onsemi.com/site/pdf/Patent-Marking.pdf. **onsemi** reserves the right to make changes at any time to any products or information herein, without notice. The information herein is provided "as-is" and **onsemi** makes no warranty, representation or guarantee regarding the accuracy of the information, product features, availability, functionality, or suitability of its products for any particular purpose, nor does **onsemi** assume any liability arising out of the application or use of any product or circuit, and specifically disclaims any and all liability, including without limitation special, consequential or incidental damages. Buyer is responsible for its products and applications using **onsemi** products, including compliance with all laws, regulations and safety requirements or standards, regardless of any support or applications information provided by **onsemi**. "Typical" parameters which may be provided in **onsemi** data sheets and/or specifications can and do vary in different applications and actual performance may vary over time. All operating parameters, including "Typicals" must be validated for each customer application by customer's technical experts. **onsemi** does not convey any license under any of its intellectual property rights nor the rights of others. **onsemi** products are not designed, intended, or authorized for use as a critical component in life support systems or any FDA Class 3 medical devices or medical devices with a same or similar classification in a foreign jurisdiction or any devices intended for implantation in the human body. Should Buyer purchase or use **onsemi** products for any such unintended or unauthorized application, Buyer shall indemnify and hold **onsemi** and its officers, employees, subsidiaries, affiliates, and distributors harmless against all claims, costs, damages, and expenses, and reasonable attorney fees arising out of, directly or indirectly, any claim of personal injury or death associated with such unintended or unauthorized use, even if such claim alleges that **onsemi** was negligent regarding the design or manufacture of the part. **onsemi** is an Equal Opportunity/Affirmative Action Employer. This literature is subject to all applicable copyright laws and is not for resale in any manner.

ADDITIONAL INFORMATION

TECHNICAL PUBLICATIONS:

Technical Library: www.onsemi.com/design/resources/technical-documentation
onsemi Website: www.onsemi.com

ONLINE SUPPORT: www.onsemi.com/support

For additional information, please contact your local Sales Representative at www.onsemi.com/support/sales