

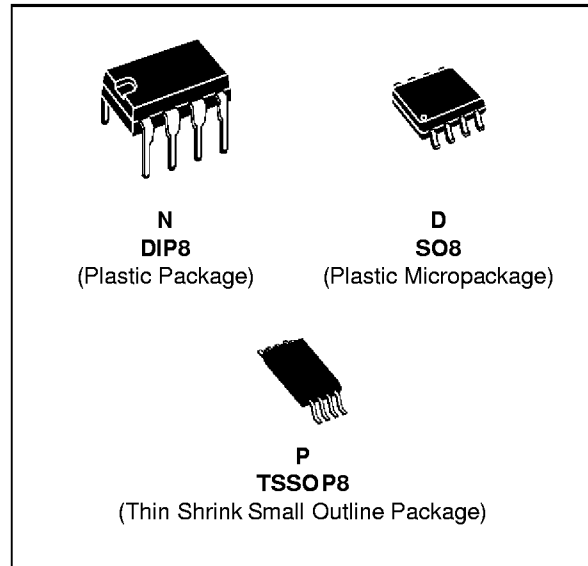

# TS27M2C,I,M

## LOW POWER CMOS DUAL OPERATIONAL AMPLIFIERS

- VERY LOW CONSUMPTION : 150µA/op
- OUTPUT VOLTAGE CAN SWING TO GROUND
- EXCELLENT PHASE MARGIN ON CAPACITIVE LOADS
- STABLE AND LOW OFFSET VOLTAGE
- THREE INPUT OFFSET VOLTAGE SELECTIONS



### DESCRIPTION

The TS272 series are low cost, low power dual operational amplifiers designed to operate with single or dual supplies. These operational amplifiers use the SGS-THOMSON silicon gate CMOS process allowing an excellent consumption-speed ratio. These series are ideally suited for low consumption applications.

Three power consumptions are available allowing to have always the best consumption-speed ratio :

- $I_{CC} = 10\mu\text{A/amp.}$  : TS27L2 (very low power)
- $I_{CC} = 150\mu\text{A/amp.}$  : TS27M2 (low power)
- $I_{CC} = 1\text{mA/amp.}$  : TS272 (high speed)

These CMOS amplifiers offer very high input impedance and extremely low input currents. The major advantage versus JFET devices is the very low input currents drift with temperature (see figure 2).

### ORDER CODES

Part Number	Temperature Range	Package		
		N	D	P
TS27M2C/AC/BC	0°C, +70°C	●	●	●
TS27M2I/AI/BI	-40°C, +125°C	●	●	●
TS27M2M/AM/BM	-55°C, +125°C	●	●	●

**Example** : TS27M2ACN

### PIN CONNECTIONS (top view)

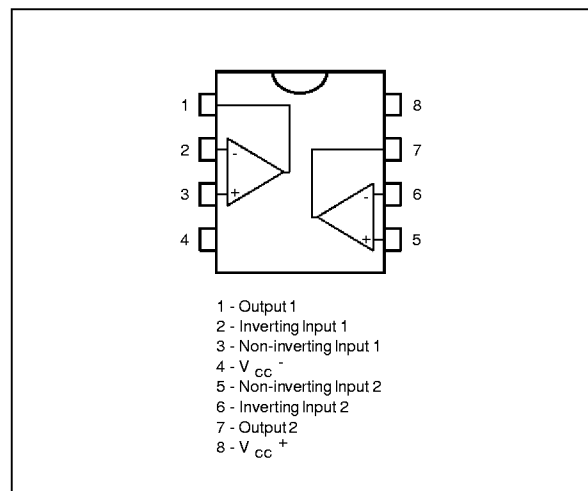

**BLOCK DIAGRAM**

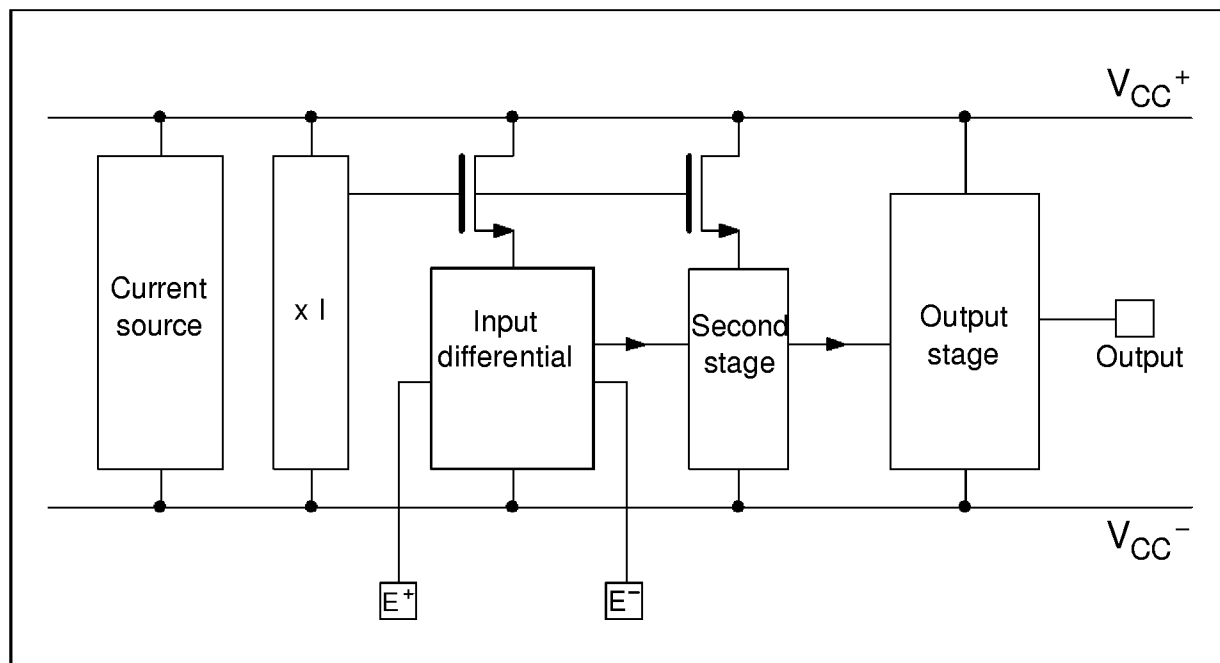

**MAXIMUM RATINGS**

Symbol	Parameter	Value	Unit
$V_{CC}^+$	Supply Voltage - (note 1)	18	V
$V_{id}$	Differential Input Voltage - (note 2)	$\pm 18$	V
$V_i$	Input Voltage - (note 3)	-0.3 to 18	V
$I_o$	Output Current for $V_{CC}^+ \geq 15V$	$\pm 30$	mA
$I_{in}$	Input Current	$\pm 5$	mA
$T_{oper}$	Operating Free-Air Temperature Range	TS27M2C/AC/BC TS27M2I/AI/BI TS27M2M/AM/BM	$^{\circ}C$
$T_{stg}$	Storage Temperature Range	-65 to +150	$^{\circ}C$

**Notes :** 1. All voltage values, except differential voltage, are with respect to network ground terminal.  
 2. Differential voltages are at the non-inverting input terminal with respect to the inverting input terminal.  
 3. The magnitude of the input and the output voltages must never exceed the magnitude of the positive supply voltage.

**OPERATING CONDITIONS**

Symbol	Parameter	Value	Unit
$V_{CC}^+$	Supply Voltage	3 to 16	V
$V_{icm}$	Common Mode Input Voltage Range	0 to $V_{CC}^+ - 1.5$	V



**ELECTRICAL CHARACTERISTICS**

$V_{CC}^+ = +10V, V_{CC}^- = 0V, T_{amb} = 25^{\circ}C$  (unless otherwise specified)

Symbol	Parameter	TS27M2C/AC/BC			TS27M2I/AI/BI TS27M2M/AM/BM			Unit
		Min.	Typ.	Max.	Min.	Typ.	Max.	
$V_{io}$	Input Offset Voltage $V_o = 1.4V, V_{ic} = 0V$ TS27M2C/I/M TS27M2AC/AI/AM TS27M2BC/BI/BM $T_{min.} \leq T_{amb} \leq T_{max.}$ TS27M2C/I/M TS27M2AC/AI/AM TS27M2BC/BI/BM		1.1 0.9 0.25	10 5 2 12 6.5 3		1.1 0.9 0.25	10 5 2 12 6.5 3.5	mV
$DV_{io}$	Input Offset Voltage Drift		2			2		$\mu V/^{\circ}C$
$I_{io}$	Input Offset Current - (note 1) $V_{ic} = 5V, V_o = 5V$ $T_{min.} \leq T_{amb} \leq T_{max.}$		1	100		1	200	pA
$I_{ib}$	Input Bias Current - (note 1) $V_{ic} = 5V, V_o = 5V$ $T_{min.} \leq T_{amb} \leq T_{max.}$		1	150		1	300	pA
$V_{OH}$	High Level Output Voltage $V_{id} = 100mV, R_L = 100k\Omega$ $T_{min.} \leq T_{amb} \leq T_{max.}$	8.7 8.6	8.9		8.7 8.5	8.9		V
$V_{OL}$	Low Level Output Voltage $V_{id} = -100mV$			50			50	mV
$A_{vd}$	Large Signal Voltage Gain $V_o = 1V$ to $6V, R_L = 100k\Omega, V_{ic} = 5V$ $T_{min.} \leq T_{amb} \leq T_{max.}$	30 20	50		30 10	50		V/mV
GBP	Gain Bandwidth Product $A_v = 40dB, R_L = 100k\Omega, C_L = 100pF$ $f_{in} = 100kHz$		1			1		MHz
CMR	Common Mode Rejection Ratio $V_o = 1.4V, V_{ic} = 1V$ to $7.4V$	65	80		65	80		dB
SVR	Supply Voltage Rejection Ratio $V_{CC}^+ = 5V$ to $10V, V_o = 1.4V$	60	80		60	80		dB
$I_{CC}$	Supply Current (per amplifier) $A_v = 1, \text{no load}, V_o = 5V$ $T_{min.} \leq T_{amb} \leq T_{max.}$		150	200 250		150	200 300	$\mu A$
$I_o$	Output Short Circuit Current $V_{id} = 100mV, V_o = 0V$		60			60		mA
$I_{sink}$	Output Sink Current $V_{id} = -100mV, V_o = V_{CC}$		45			45		mA
SR	Slew-Rate at Unity Gain $R_L = 100k\Omega, C_L = 100pF, V_i = 3$ to $7V$		0.6			0.6		$V/\mu s$
$\phi_m$	Phase Margin at Unity Gain $A_v = 40dB, R_L = 100k\Omega, C_L = 100pF$		45			45		Degrees
$K_{ov}$	Overshoot Factor		30			30		%
$e_n$	Equivalent Input Noise Voltage $f = 1kHz, R_S = 100\Omega$		38			38		$\frac{nV}{\sqrt{Hz}}$
$V_{O1}/V_{O2}$	Channel Separation		120			120		dB

**Note :** 1. Maximum values including unavoidable inaccuracies of the industrial test.

TYPICAL CHARACTERISTICS

Figure 1 : Supply Current (each amplifier) versus Supply Voltage

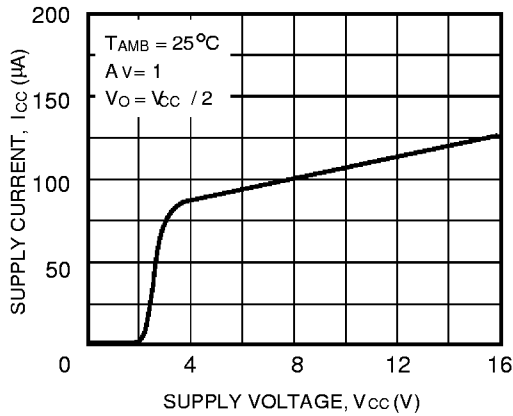

Figure 2 : Input Bias Current versus Free Air Temperature

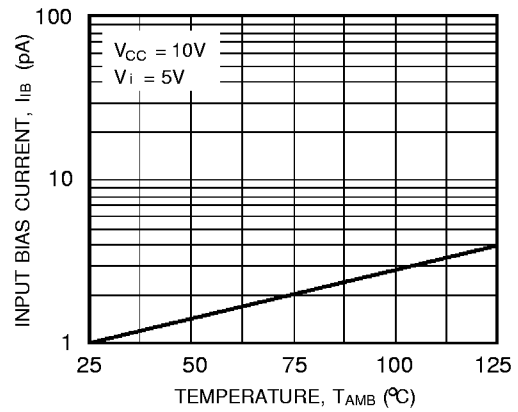

Figure 3a : High Level Output Voltage versus High Level Output Current

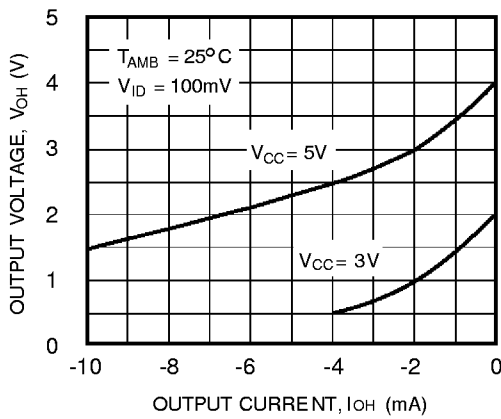

Figure 3b : High Level Output Voltage versus High Level Output Current

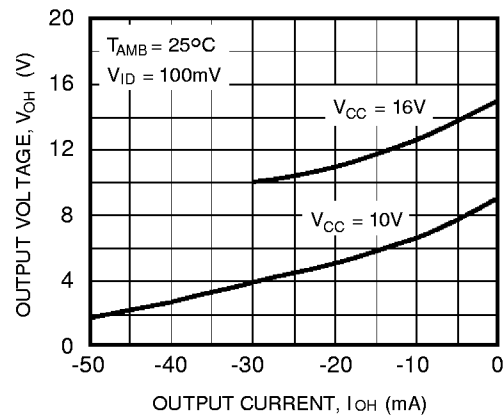

Figure 3a : Low Level Output Voltage versus Low Level Output Current

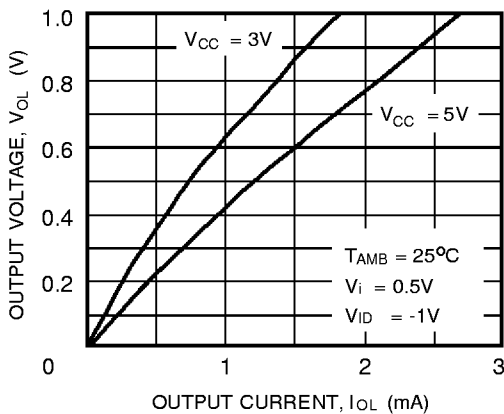
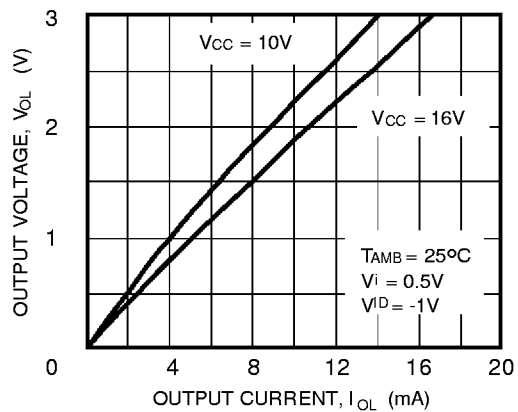

Figure 3b : Low Level Output Voltage versus Low Level Output Current



TYPICAL CHARACTERISTICS (continued)

Figure 5 : Open Loop Frequency Response and Phase Shift

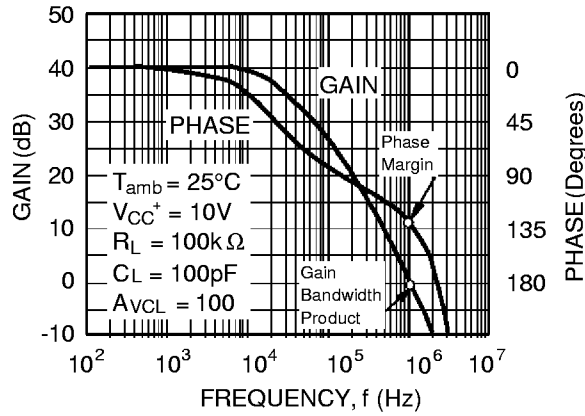

Figure 6 : Gain Bandwidth Product versus Supply Voltage

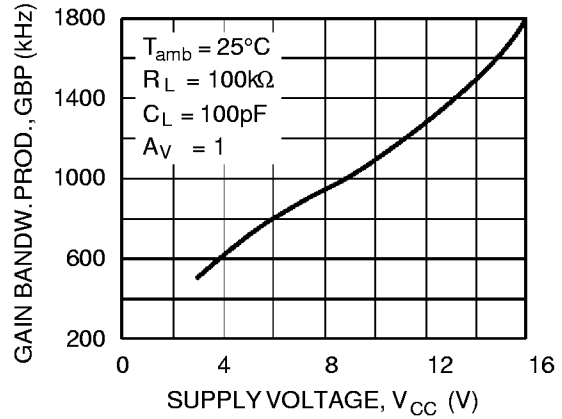

Figure 7 : Phase Margin versus Supply Voltage

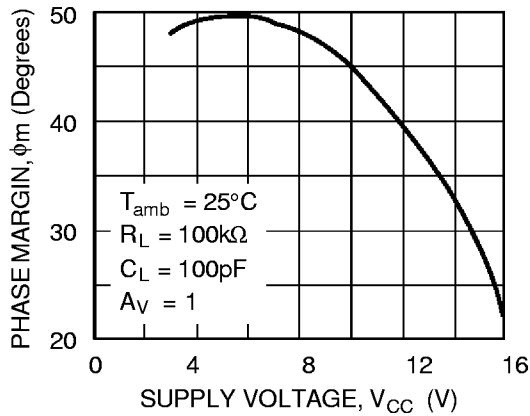

Figure 8 : Phase Margin versus Capacitive Load

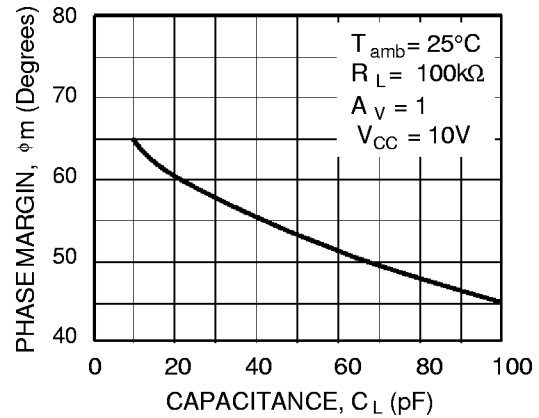

Figure 9 : Slew Rate versus Supply Voltage

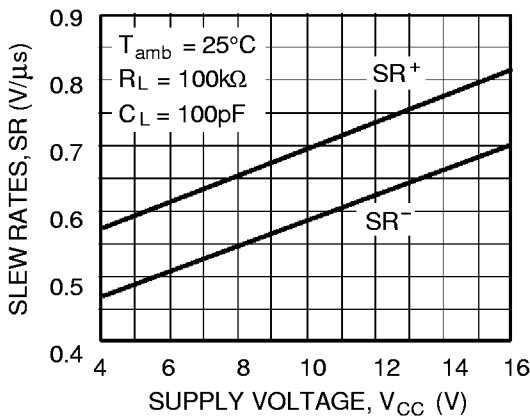
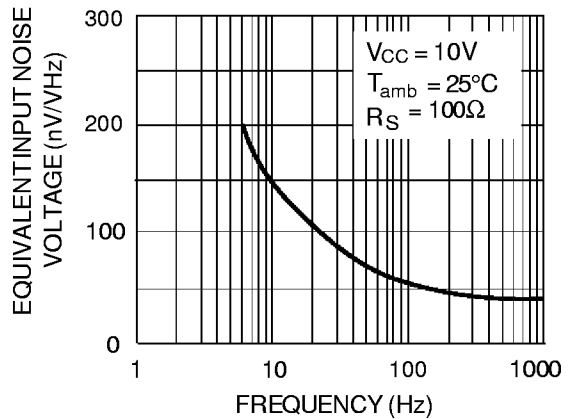
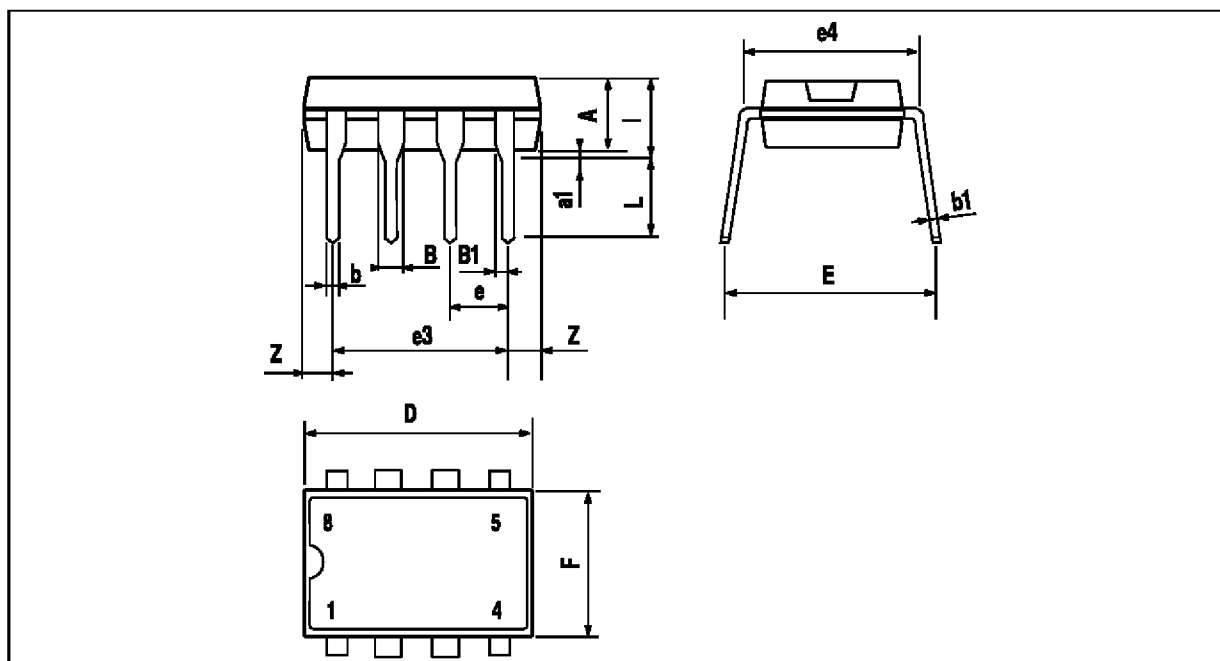

Figure 10 : Input Voltage Noise versus Frequency



**PACKAGE MECHANICAL DATA**  
8 PINS - PLASTIC DIP



PM-DIP8.EPS

Dimensions	Millimeters			Inches		
	Min.	Typ.	Max.	Min.	Typ.	Max.
A		3.32			0.131	
a1	0.51			0.020		
B	1.15		1.65	0.045		0.065
b	0.356		0.55	0.014		0.022
b1	0.204		0.304	0.008		0.012
D			10.92			0.430
E	7.95		9.75	0.313		0.384
e		2.54			0.100	
e3		7.62			0.300	
e4		7.62			0.300	
F			6.6			0.260
i			5.08			0.200
L	3.18		3.81	0.125		0.150
Z			1.52			0.060

DIP8.TBL

# TS27M2C,I,M

## PACKAGE MECHANICAL DATA 8 PINS - PLASTIC MICROPACKAGE (SO)

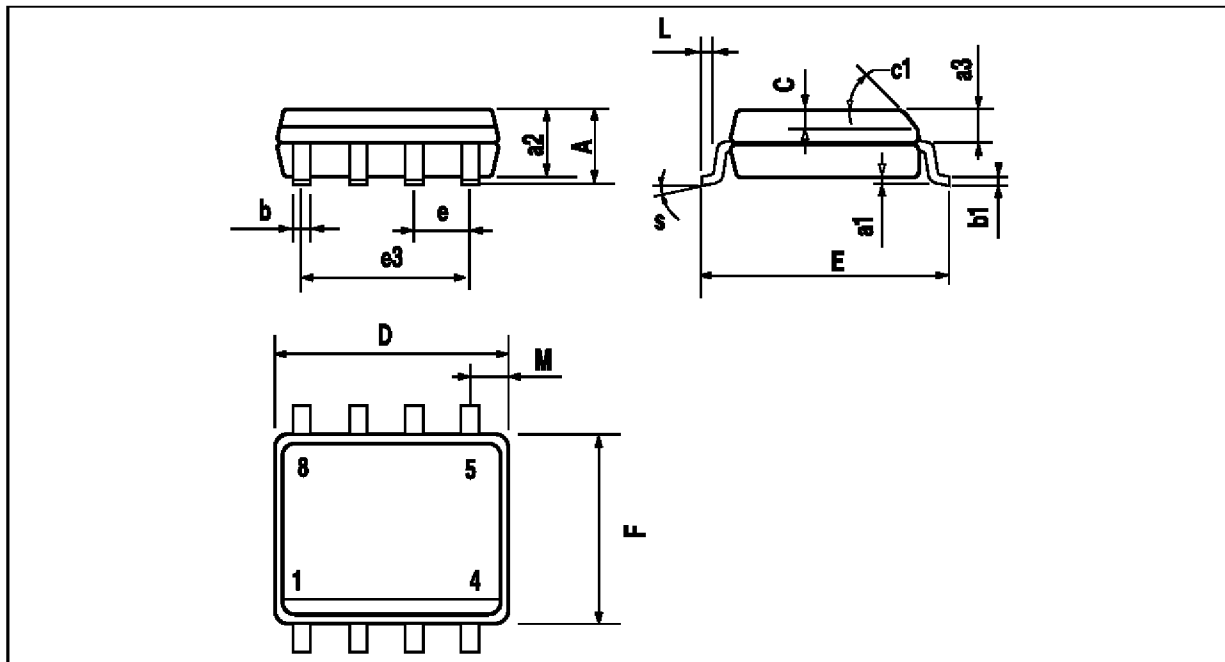

PM-S08.EPS

Dimensions	Millimeters			Inches		
	Min.	Typ.	Max.	Min.	Typ.	Max.
A			1.75			0.069
a1	0.1		0.25	0.004		0.010
a2			1.65			0.065
a3	0.65		0.85	0.026		0.033
b	0.35		0.48	0.014		0.019
b1	0.19		0.25	0.007		0.010
C	0.25		0.5	0.010		0.020
c1	45° (typ.)					
D	4.8		5.0	0.189		0.197
E	5.8		6.2	0.228		0.244
e		1.27			0.050	
e3		3.81			0.150	
F	3.8		4.0	0.150		0.157
L	0.4		1.27	0.016		0.050
M			0.6			0.024
S	8° (max.)					

S08.TBL



**PACKAGE MECHANICAL DATA**

**8 PINS - THIN SHRINK SMALL OUTLINE PACKAGE**

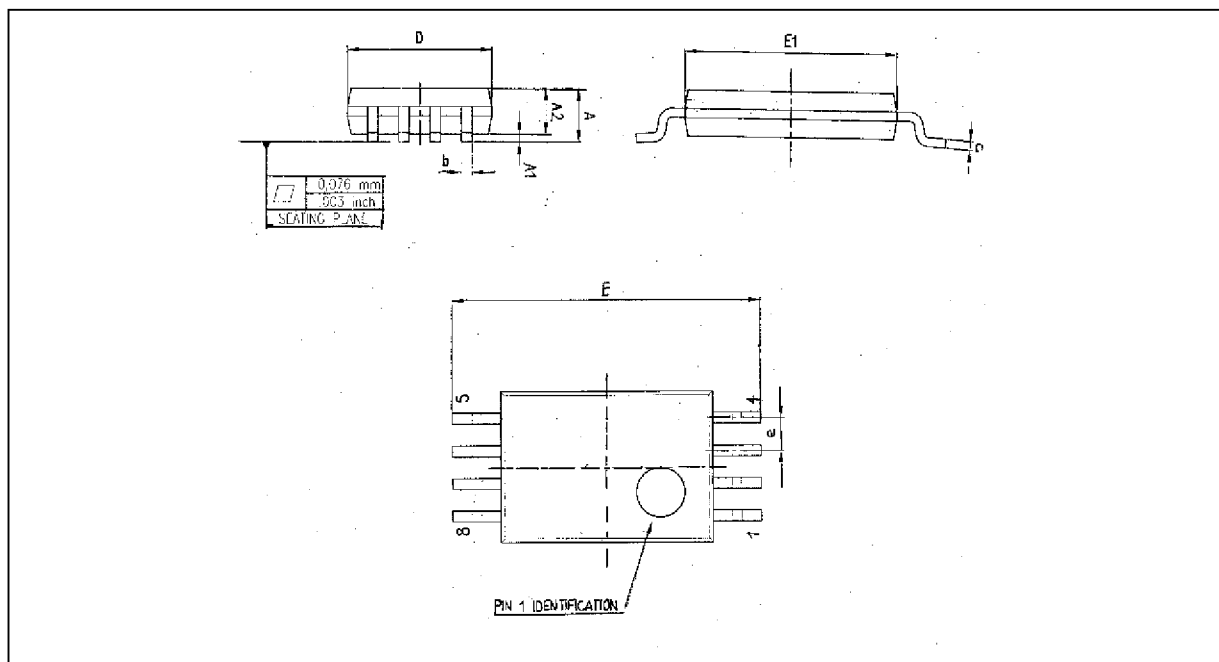

Dim.	Millimeters			Inches		
	Min.	Typ.	Max.	Min.	Typ.	Max.
A			1.20			0.05
A1	0.05		0.15	0.01		0.006
A2	0.80	1.00	1.05	0.031	0.039	0.041
b	0.19		0.30	0.007		0.15
c	0.09		0.20	0.003		0.012
D	2.90	3.00	3.10	0.114	0.118	0.122
E		6.40			0.252	
E1	4.30	4.40	4.50	0.169	0.173	0.177
e		0.65			0.025	
k	0°		8°	0°		8°
l	0.50	0.60	0.75	0.09	0.0236	0.030

Information furnished is believed to be accurate and reliable. However, STMicroelectronics assumes no responsibility for the consequences of use of such information nor for any infringement of patents or other rights of third parties which may result from its use. No license is granted by implication or otherwise under any patent or patent rights of STMicroelectronics. Specifications mentioned in this publication are subject to change without notice. This publication supersedes and replaces all information previously supplied. STMicroelectronics products are not authorized for use as critical components in life support devices or systems without express written approval of STMicroelectronics.

© The ST logo is a trademark of STMicroelectronics

© 1998 STMicroelectronics – Printed in Italy – All Rights Reserved  
 STMicroelectronics GROUP OF COMPANIES

Australia - Brazil - Canada - China - France - Germany - Italy - Japan - Korea - Malaysia - Malta - Mexico - Morocco  
 The Netherlands - Singapore - Spain - Sweden - Switzerland - Taiwan - Thailand - United Kingdom - U.S.A.

ORDER CODE :

