



DATA SHEET

15KP SERIES

GLASS PASSIVATED JUNCTION TRANSIENT VOLTAGE SUPPRESSOR

VOLTAGE	17 to 220 Volts	POWER	15000 Watts	P-600	Unit: inch(mm)
----------------	------------------------	--------------	--------------------	--------------	----------------

FEATURES

- Plastic package has Underwriters Laboratory Flammability Classification 94V-O
- Glass passivated chip junction in P-600 package
- 15000W Peak Pulse Power capability on 10/1000µs waveform
- Excellent clamping capability
- Low incremental surge resistance
- Both normal and Pb free product are available :
Normal : 80~95% Sn, 5~20% Pb
Pb free: 98.5% Sn above

MECHANICAL DATA

Case: JEDEC P-600 Molded plastic
 Terminals: Axial leads, solderable per MIL-STD-750, Method 2026
 Polarity: Color band denotes positive end (cathode)
 Mounting Position: Any
 Weight: 0.07 ounce, 2.1 gram

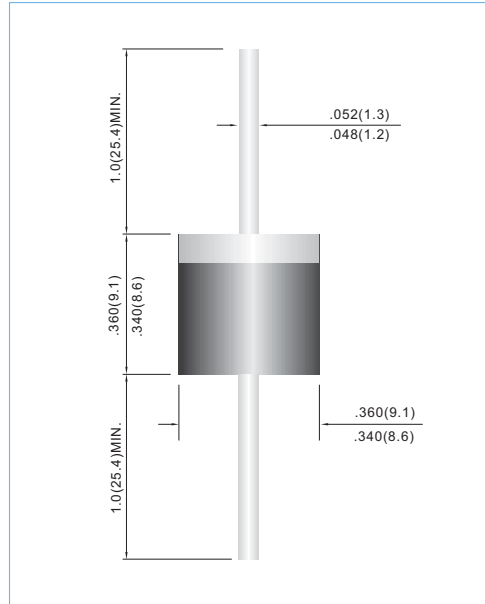

DEVICES FOR BIPOLAR APPLICATIONS

For Bidirectional use C or CA Suffix for types
 Electrical characteristics apply in both directions.

MAXIMUM RATINGS AND CHARACTERISTICS

Rating at 25°C ambient temperature unless otherwise specified. Resistive or inductive load, 60Hz.
 For Capacitive load derate current by 20%.

Rating	Symbol	Value	Units
Peak Pulse Power Dissipation on 10/1000s waveform (Note 1)	P _{PPM}	15000	Watts
Peak Pulse Current on 10/1000s waveform (Note 1)	I _{PPM}	SEE TABLE 1	Amps
Steady State Power Dissipation at T _L =50°C Lead Lengths .375", (9.5mm) (Note 2)	P _{M(AV)}	10	Amps
Peak Forward Surge Current, 8.3ms Single Half Sine-Wave Superimposed on Rated Load(JECED Method) (Note 3)	I _{FSM}	400	Amps
Operating Junction and Storage Temperature Range	T _J , T _{STG}	-55 to +175	°C

NOTES:

1. Non-repetitive current pulse, per Fig. 3 and derated above T_A=25°C per Fig. 2. Mounted on Copper Leaf area of 0.79 in²(20mm²).
3. 8.3ms single half sine-wave, duty cycle= 4 pulses per minutes maximum.



PART NUMBER		VRWM	VBR @ IT			IR @ VRWM		VC @ IPP	
			MIN.	MAX.	IT	UNI-	BI-	V	A
UNI-	BI-	V	V	V	MA	UA	UA		
15000W TRANSIENT VOLTAGE SUPPRESSOR									
15KPJ17	15KPJ17C	17	18.90	23.90	50	5000	5000	30.5	520
15KP17A	15KP17CA	17	18.90	21.70	50	5000	5000	27.6	543
15KP18	15KP18C	18	20.00	25.30	50	5000	5000	32.2	439
15KP18A	15KP18CA	18	20.00	23.30	50	5000	5000	29.2	485
15KP20	15KP20C	20	22.20	28.10	20	1500	1500	35.8	396
15KP20A	15KP20CA	20	22.20	25.50	20	1500	1500	32.4	437
15KP22	15KP22C	22	24.40	30.90	10	900	900	39.4	365
15KP22A	15KP22CA	22	24.40	28.00	10	900	900	35.5	404
15KP24	15KP24C	24	26.70	33.80	5.0	800	800	43.0	333
15KP24A	15KP24CA	24	26.70	30.70	5.0	800	800	38.9	369
15KP26	15KP26C	26	28.90	36.60	5.0	200	200	46.6	308
15KP26A	15KP26CA	26	28.90	33.20	5.0	200	200	42.1	341
15KP28	15KP28C	28	31.10	39.40	5.0	125	125	50.0	286
15KP28A	15KP28CA	28	31.10	35.80	5.0	125	125	45.4	316
15KP30	15KP30C	30	33.30	42.20	5.0	28	28	53.5	267
15KP30A	15KP30CA	30	33.30	38.30	5.0	28	28	48.4	296
15KP33	15KP33C	33	36.70	46.50	5.0	10	10	59.0	248
15KP33A	15KP33CA	33	36.70	42.20	5.0	10	10	53.3	274
15KP36	15KP36C	36	40.00	50.70	5.0	10	10	64.3	227
15KP36A	15KP36CA	36	40.00	46.00	5.0	10	10	58.1	251
15KP40	15KP40C	40	44.40	56.30	5.0	10	10	71.4	206
15KP40A	15KP40CA	40	44.40	51.10	5.0	10	10	64.5	228
15KP43	15KP43C	43	47.80	60.50	5.0	10	10	76.7	195
15KP43A	15KP43CA	43	47.80	54.90	5.0	10	10	69.4	215
15KP45	15KP45C	45	50.00	63.30	5.0	10	10	80.3	186
15KP45A	15KP45CA	45	50.00	57.50	5.0	10	10	72.7	205
15KP48	15KP48C	48	53.30	67.50	5.0	10	10	85.5	175
15KP48A	15KP48CA	48	53.30	61.30	5.0	10	10	77.4	193
15KP51	15KP51C	51	56.70	71.80	5.0	10	10	91.1	164
15KP51A	15KP51CA	51	56.70	65.20	5.0	10	10	82.4	181
15KP54	15KP54C	54	60.00	76.00	5.0	10	10	96.3	155
15KP54A	15KP54CA	54	60.00	69.00	5.0	10	10	87.1	171
15KP58	15KP58C	58	64.40	81.60	5.0	10	10	103	144
15KP58A	15KP58CA	58	64.40	74.10	5.0	10	10	93.6	160
15KP60	15KP60C	60	66.70	84.50	5.0	10	10	107	140
15KP60A	15KP60CA	60	66.70	76.70	5.0	10	10	96.8	154



PART NUMBER		V _{RWM}	VBR @ IT			IR @ V _{RWM}		VC @ IPP	
			MIN.	MAX.	I _T	UNI-	BI-		
UNI-	BI-	V	V	V	MA	UA	UA	V	A
15000W TRANSIENT VOLTAGE SUPPRESSOR									
15KP64	15KP64C	64	71.1	90.1	5.0	10	10	114	130
15KP64A	15KP64CA	64	71.1	81.8	5.0	10	10	103	144
15KP70	15KP70C	70	77.8	98.6	5.0	10	10	125	119
15KP70A	15KP70CA	70	77.8	89.5	5.0	10	10	113	132
15KP75	15KP75C	75	83.3	105.7	5.0	10	10	134	111
15KP75A	15KP75CA	75	83.3	95.8	5.0	10	10	121	123
15KP78	15KP78C	78	86.7	109.8	5.0	10	10	139	107
15KP78A	15KP78CA	78	86.7	99.7	5.0	10	10	126	119
15KP85	15KP85C	85	94.4	119.2	5.0	10	10	151	99
15KP85A	15KP85CA	85	94.4	108.2	5.0	10	10	137	109
15KP90	15KP90C	90	100	126.5	5.0	10	10	160	94
15KP90A	15KP90CA	90	100	115.5	5.0	10	10	146	103
15KP100	15KP100C	100	111	141.0	5.0	10	10	179	84
15KP100A	15KP100CA	100	111	128.0	5.0	10	10	162	93
15KP110	15KP110C	110	122	154.5	5.0	10	10	196	77
15KP110A	15KP110CA	110	122	140.5	5.0	10	10	177	85
15KP120	15KP120C	120	133	169.0	5.0	10	10	214	70
15KP120A	15KP120CA	120	133	153.0	5.0	10	10	193	78
15KP130	15KP130C	130	144	182.5	5.0	10	10	231	65
15KP130A	15KP130CA	130	144	165.5	5.0	10	10	209	72
15KP150	15KP150C	150	167	211.5	5.0	10	10	268	56
15KP150A	15KP150CA	150	167	192.5	5.0	10	10	243	62
15KP160	15KP160C	160	178	226.0	5.0	10	10	287	52
15KP160A	15KP160CA	160	178	205.0	5.0	10	10	259	58
15KP170	15KP170C	170	189	239.5	5.0	10	10	304	49
15KP170A	15KP170CA	170	189	217.5	5.0	10	10	275	55
15KP180	15KP180C	180	198	253.8	1.0	5	5	322	47
15KP180A	15KP180CA	180	198	230.4	1.0	5	5	292	51
15KP190	15KP190C	190	209	267.9	1.0	5	5	340	44
15KP190A	15KP190CA	190	209	243.2	1.0	5	5	308	49
15KP200	15KP200C	200	220	282.0	1.0	5	5	358	42
15KP200A	15KP200CA	200	220	256.0	1.0	5	5	324	46
15KP210	15KP210C	210	231	296.1	1.0	5	5	376	40
15KP210A	15KP210CA	210	231	268.8	1.0	5	5	340	44
15KP220	15KP220C	220	242	310.2	1.0	5	5	394	38
15KP220A	15KP220CA	220	242	281.6	1.0	5	5	356	42

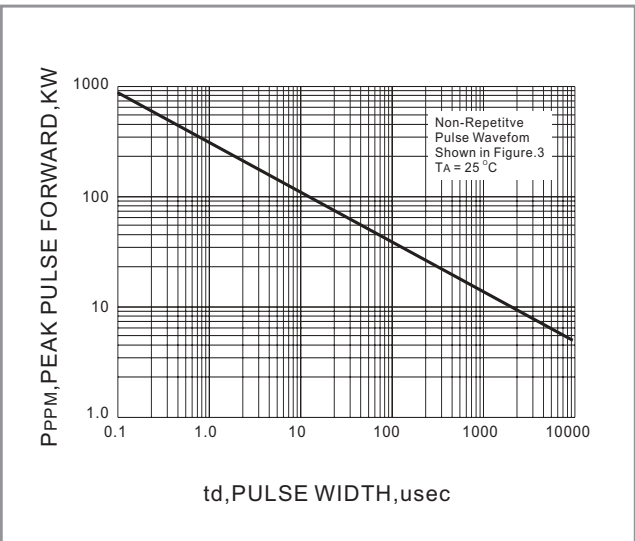

Fig.1 PEAK PULSE POWER RATING VERSUS PULSE TIME CURVE

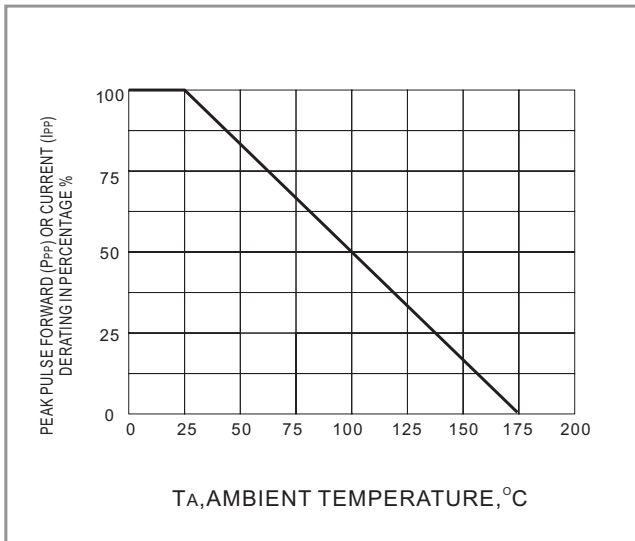

Fig.2 PULSE DERATING CURVE

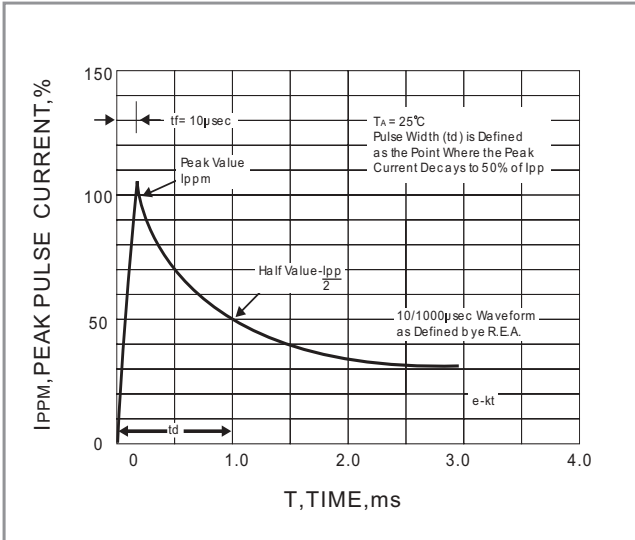

Fig.3 PULSE WAVEFORM

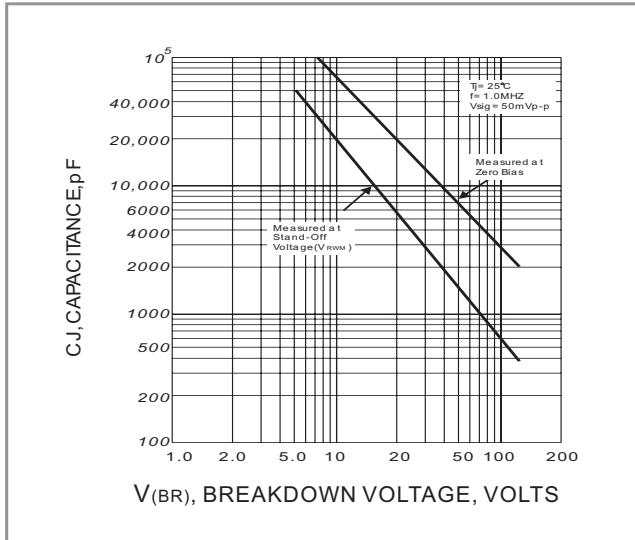

Fig.4 TYPICAL JUNCTION CAPACITANCE

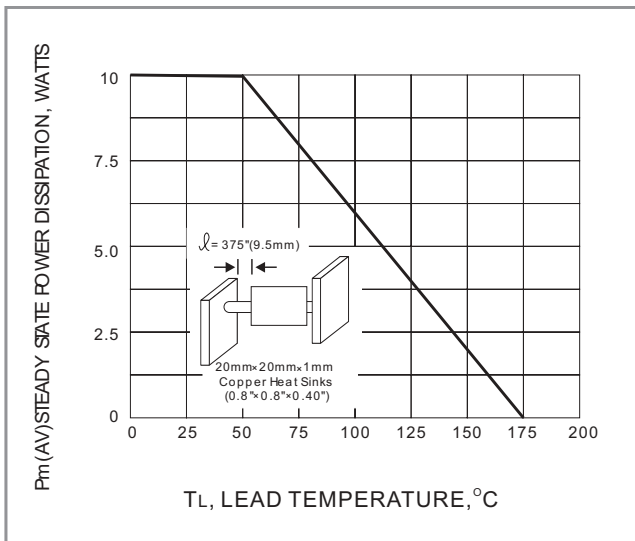

Fig.5 STEADY STATE POWER DERATING

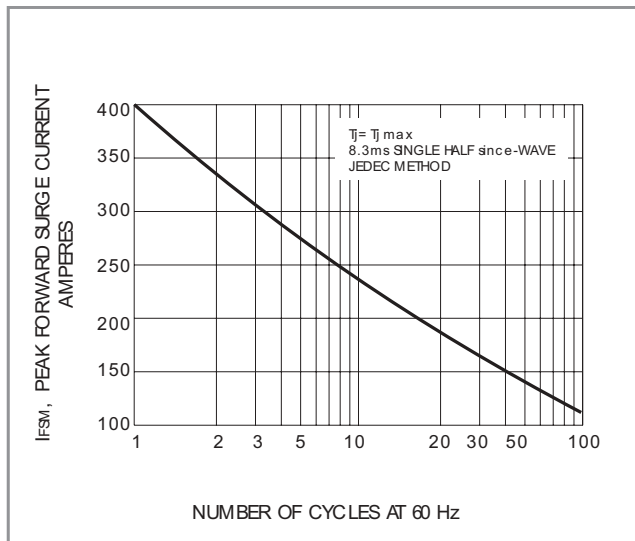

Fig.6 MAXIMUM NON-REPETITIVE PEAK FORWARD SURGE CURRENT UNIDIRECTIONAL