

# KM4211

## Dual, 0.2mA, Low Cost, +2.7V & +5V, 35MHz Rail-to-Rail Amp

### Features

- 208µA supply current
- 35MHz bandwidth
- Fully specified at +2.7V and +5V supplies
- Output voltage range: 0.08V to 4.88V;  $V_s = +5$
- Input voltage range: -0.3V to +3.8V;  $V_s = +5$
- 27V/µs slew rate
- ±8.5mA linear output current
- ±13mA short circuit output current
- 21nV/√Hz input voltage noise
- Directly replaces OPA2350, MAX4132, MAX4281
- Small package options (SOIC-8 and MSOP-8)

### Applications

- A/D buffer
- Smart card readers
- Active filters
- Keyless entry
- Signal conditioning
- ASCII input devices
- Portable test instruments
- PC/MUA cards
- Portable communications
- Bar-code readers
- Portable/battery-powered applications

### KM4211 Packages

#### SOIC-8

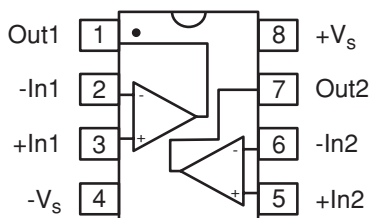

#### MSOP-8

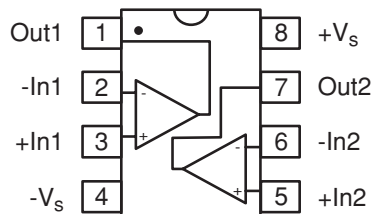

### General Description

The KM4211 is a dual ultra-low power, low cost, voltage feedback amplifier. The KM4211 uses only 208µA of supply current per amplifier and is designed to operate from 2.5V to 5.5V or ±1.25V to ±2.75V supplies. The input voltage range extends 300mV below the negative rail and 1.2V below the positive rail.

The KM4211 offers high bipolar performance at a low CMOS price. The KM4211 offers superior dynamic performance with a 35MHz small signal bandwidth and 27V/µs slew rate. The combination of low power, high bandwidth, and rail-to-rail performance make the KM4211 well suited for battery-powered communication/computing systems.

The KM4112 (single) and KM4121 (single with disable) are also available.

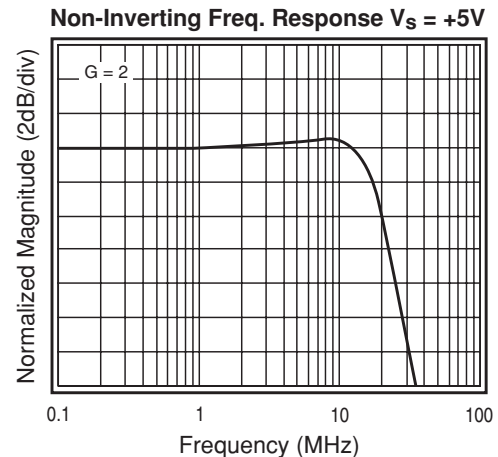

## KM4211 Electrical Characteristics ( $V_s = +2.7V$ , $G = 2$ , $R_L = 2k\Omega$ to $V_s/2$ , $R_f = 2.5k\Omega$ ; unless noted)

PARAMETERS	CONDITIONS	TYP	MIN & MAX	UNITS	NOTES
Case Temperature		+25°C	+25°C		
<b>Frequency Domain Response</b>					
-3dB bandwidth	$G = +1, V_O = 0.05V_{pp}$	28		MHz	1
full power bandwidth	$G = +2, V_O < 0.2V_{pp}$	15		MHz	
gain bandwidth product	$G = -1, V_O = 2V_{pp}$	7		MHz	
		16		MHz	
<b>Time Domain Response</b>					
rise and fall time	0.2V step	20		ns	
settling time to 0.1%	1V step	140		ns	
overshoot	2V step, $G = -1$	<1		%	
slew rate	2V step, $G = -1$	20		V/ $\mu$ s	
<b>Distortion and Noise Response</b>					
2nd harmonic distortion	$1V_{pp}, 100kHz$	85		dBc	
3rd harmonic distortion	$1V_{pp}, 100kHz$	63		dBc	
THD	$1V_{pp}, 100kHz$	62		dB	
input voltage noise	>10kHz	23		nV/ $\sqrt{Hz}$	
crosstalk	100kHz, $V_O = 0.2V_{pp}$	98		dB	
<b>DC Performance</b>					
input offset voltage		0.8	$\pm 5$	mV	2
average drift		11		$\mu$ V/ $^{\circ}C$	
input bias current		0.4	1.3	$\mu$ A	2
average drift		1		nA/ $^{\circ}C$	
input offset current		8	130	nA	2
power supply rejection ratio	DC	60	56	dB	2
open loop gain		65	56	dB	2
quiescent current		185	245	$\mu$ A	2
<b>Input Characteristics</b>					
input resistance		>10		M $\Omega$	
input capacitance		1.5		pF	
input common mode voltage range		-0.3 to 1.5		V	
common mode rejection ratio	DC, $V_{cm} = 0V$ to $V_s - 1.5$	92	65	dB	2
<b>Output Characteristics</b>					
output voltage swing	$R_L = 10k\Omega$ to $V_s/2$ $R_L = 2k\Omega$ to $V_s/2$	0.06 to 2.62 0.08 to 2.6	0.2 to 2.4	V	2
linear output current		$\pm 8$		mA	
short circuit output current		$\pm 12.5$		mA	
power supply operating range		2.7	2.5 to 5.5	V	

Min/max ratings are based on product characterization and simulation. Individual parameters are tested as noted. Outgoing quality levels are determined from tested parameters.

### NOTES:

- 1) For  $G = +1$ ,  $R_f = 0$ .
- 2) 100% tested at +25°C.

## Absolute Maximum Ratings

supply voltage	0 to +6V
maximum junction temperature	+175°C
storage temperature range	-65°C to +150°C
lead temperature (10 sec)	+260°C
operating temperature range (recommended)	-40°C to +85°C
input voltage range	+ $V_s$ +0.5V; - $V_s$ -0.5V
internal power dissipation	see power derating curves

## Package Thermal Resistance

Package	$\theta_{JA}$
8 lead SOIC	152°C/W
8 lead MSOP	206°C/W

## KM4211 Electrical Characteristics ( $V_s = +2.7V$ , $G = 2$ , $R_L = 2k\Omega$ to $V_s/2$ , $R_f = 2.5k\Omega$ ; unless noted)

PARAMETERS	CONDITIONS	TYP	MIN & MAX	UNITS	NOTES
Case Temperature		+25°C	+25°C		
<b>Frequency Domain Response</b>					
-3dB bandwidth	$G = +1, V_O = 0.05V_{pp}$	35		MHz	1
full power bandwidth	$G = +2, V_O < 0.2V_{pp}$	18		MHz	
gain bandwidth product	$G = -1, V_O = 2V_{pp}$	8		MHz	
		20		MHz	
<b>Time Domain Response</b>					
rise and fall time	0.2V step	18		ns	
settling time to 0.1%	2V step	140		ns	
overshoot	2V step, $G = -1$	<1		%	
slew rate	2V step, $G = -1$	27		V/ $\mu$ s	
<b>Distortion and Noise Response</b>					
2nd harmonic distortion	$2V_{pp}, 100kHz$	78		dBc	
3rd harmonic distortion	$2V_{pp}, 100kHz$	66		dBc	
THD	$2V_{pp}, 100kHz$	65		dB	
input voltage noise	>10kHz	21		nV/ $\sqrt{Hz}$	
crosstalk	100kHz, $V_O = 0.2V_{pp}$	98		dB	
<b>DC Performance</b>					
input offset voltage		-1.5		mV	
average drift		20		$\mu$ V/ $^{\circ}C$	
input bias current		0.4		$\mu$ A	
average drift		1		nA/ $^{\circ}C$	
input offset current		7		nA	
power supply rejection ratio	DC	60		dB	
open loop gain		62		dB	
quiescent current		208		$\mu$ A	
<b>Input Characteristics</b>					
input resistance		>10		M $\Omega$	
input capacitance		1.35		pF	
input common mode voltage range		-0.3 to 3.8		V	
common mode rejection ratio	DC, $V_{cm} = 0V$ to $V_s - 1.5$	85		dB	
<b>Output Characteristics</b>					
output voltage swing	$R_L = 10k\Omega$ to $V_s/2$	0.08 to 4.88		V	
	$R_L = 2k\Omega$ to $V_s/2$	0.1 to 4.8		V	
linear output current		$\pm 8.5$		mA	
short circuit output current		$\pm 13$		mA	
power supply operating range		5	2.5 to 5.5	V	

Min/max ratings are based on product characterization and simulation. Individual parameters are tested as noted. Outgoing quality levels are determined from tested parameters.

### NOTES:

1) For  $G = +1$ ,  $R_f = 0$ .

**KM4211 Performance Characteristics** ( $V_S = +5V$ ,  $G = 2$ ,  $R_L = 2k\Omega$  to  $V_S/2$ ,  $R_f = 2.5k\Omega$ ; unless noted)

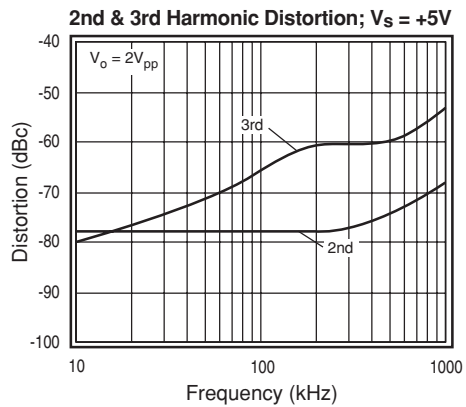
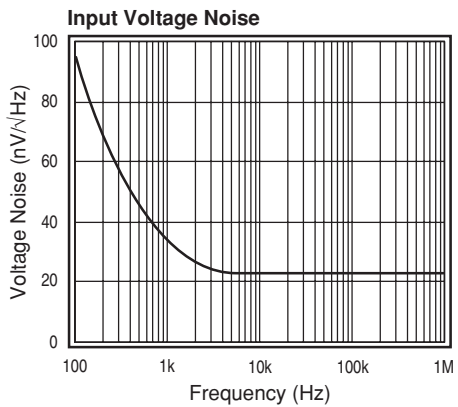
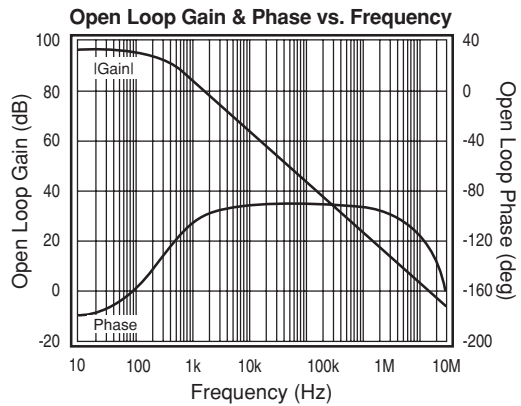
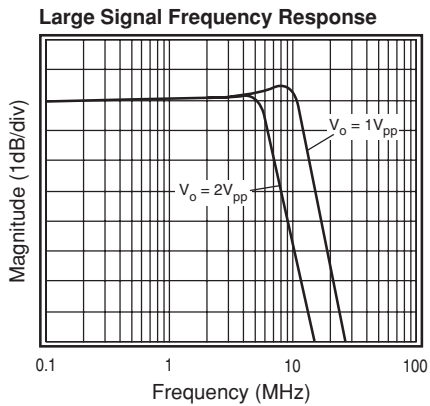
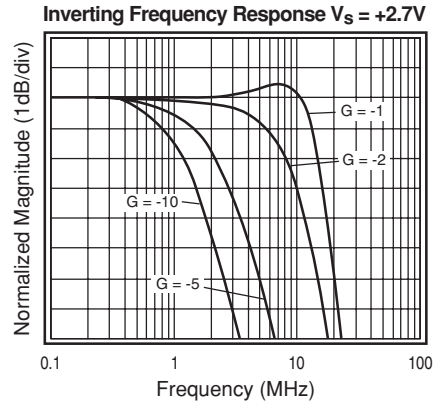
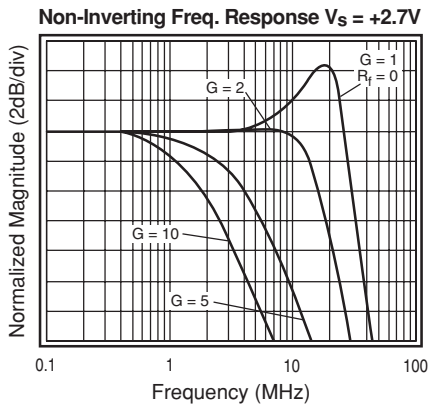
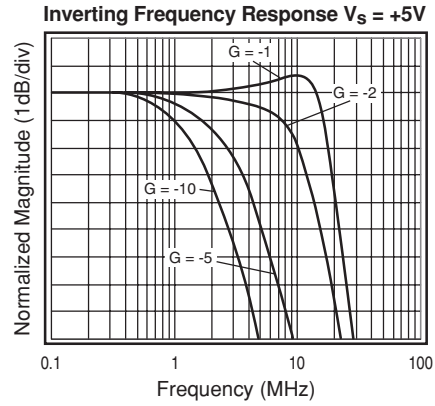
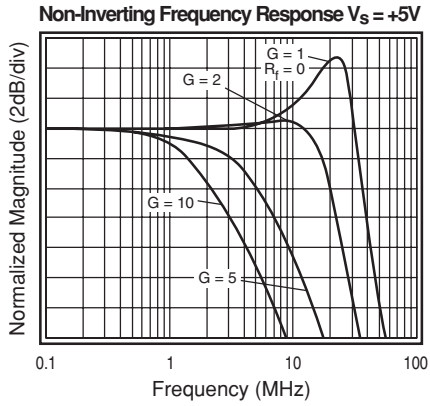

**KM4211 Performance Characteristics** ( $V_s = +5V$ ,  $G = 2$ ,  $R_L = 2k\Omega$  to  $V_s/2$ ,  $R_f = 2.5k\Omega$ ; unless noted)

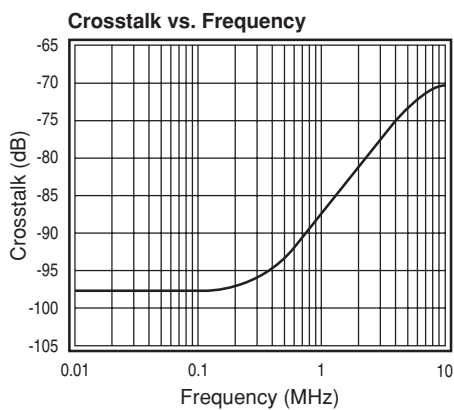
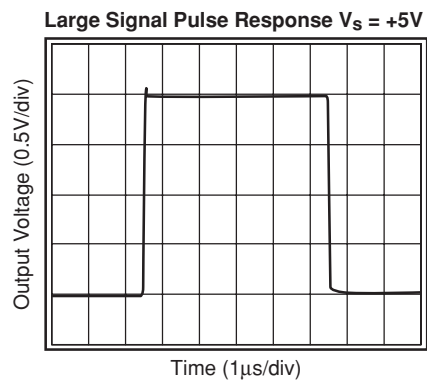
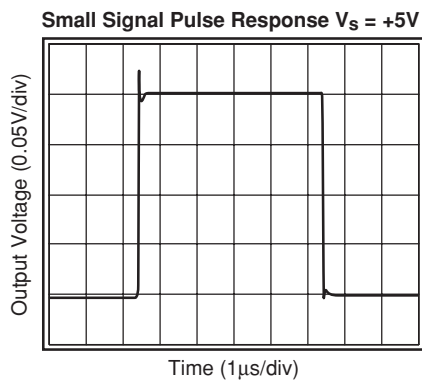
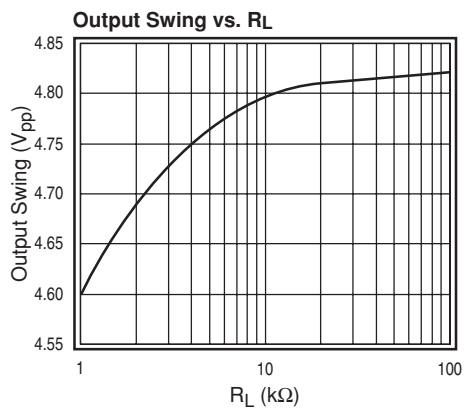
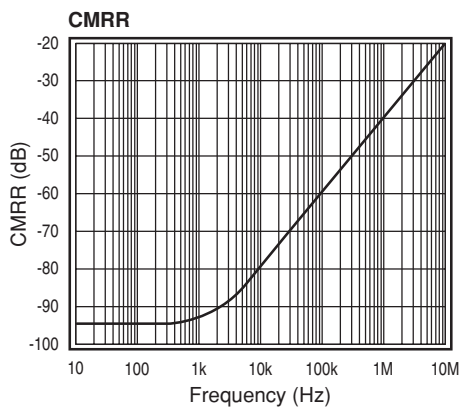
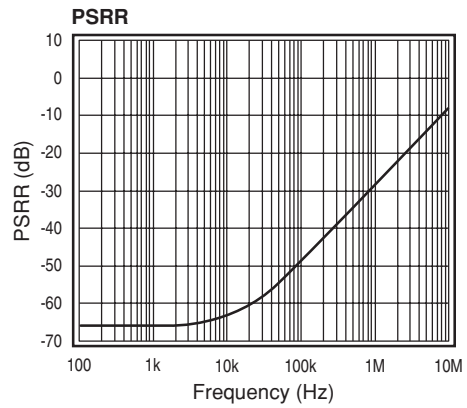
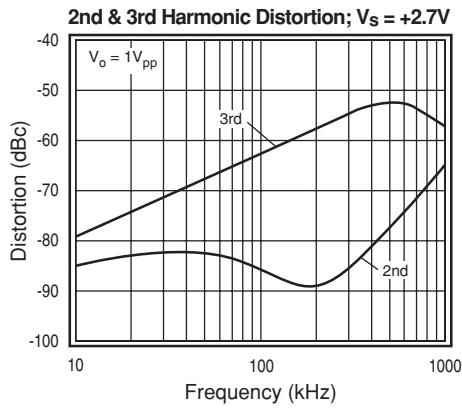

**General Description**

The KM4211 is a single supply, general purpose, voltage-feedback amplifier fabricated on a complementary bipolar process. The KM4211 offers 35MHz unity gain bandwidth, 27V/ $\mu$ s slew rate, and only 208 $\mu$ A supply current. It features a rail-to-rail output stage and is unity gain stable.

The design utilizes a patent pending topology that provides increased slew rate performance. The common mode input range extends to 300mV below ground and to 1.2V below  $V_s$ . Exceeding these values will not cause phase reversal. However, if the input voltage exceeds the rails by more than 0.5V, the input ESD devices will begin to conduct. The output will stay at the rail during this overdrive condition.

The design uses a Darlington output stage. The output stage is short circuit protected and offers "soft" saturation protection that improves recovery time.

The typical circuit schematic is shown in Figure 1.

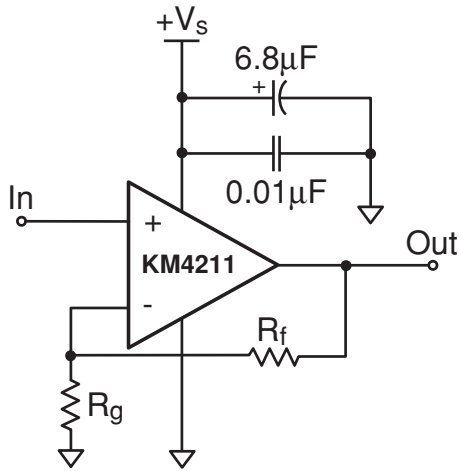

**Figure 1: Typical Configuration**

**Enable/Disable Function (KM4211)**

The KM4211 offers an active-low disable pin that can be used to lower its supply current. Leave the pin floating to enable the part. Pull the disable pin to the negative supply (which is ground in a single supply application) to disable the output. During the disable condition, the nominal supply current will drop to below 40 $\mu$ A and the output will be at high impedance with about 2pF capacitance.

**Power Dissipation**

The maximum internal power dissipation allowed is directly related to the maximum junction temperature. If the maximum junction temperature exceeds 150°C, some reliability degradation will occur. If the maximum junction temperature exceeds 175°C for an extended time, device failure may occur.

The KM4211 is short circuit protected. However, this may not guarantee that the maximum junction temperature (+150°C) is not exceeded under all conditions. Follow the maximum power derating curves shown in Figure 2 to ensure proper operation.

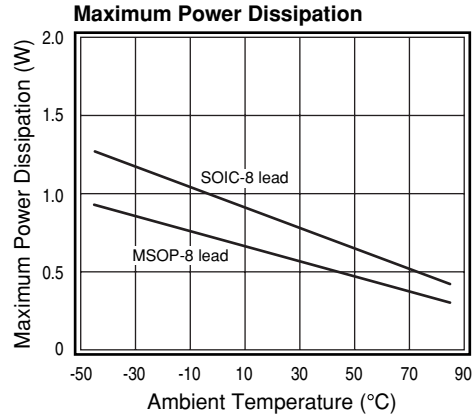

**Figure 2: Power Derating Curves**

**Overdrive Recovery**

For an amplifier, an overdrive condition occurs when the output and/or input ranges are exceeded. The recovery time varies based on whether the input or output is overdriven and by how much the ranges are exceeded. The KM4211 will typically recover in less than 20ns from an overdrive condition. Figure 3 shows the KM4211 in an overdriven condition.

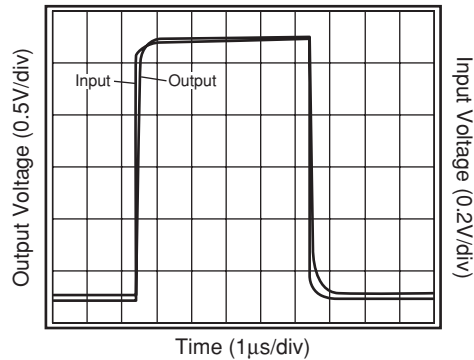

**Figure 3: Overdrive Recovery**

**Driving Capacitive Loads**

A small series resistance ( $R_s$ ) at the output of the amplifier, illustrated in Figure 4, will improve stability and settling performance.

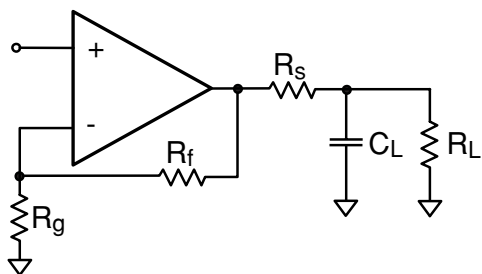

Figure 4: Typical Topology for driving a capacitive load

**Layout Considerations**

General layout and supply bypassing play major roles in high frequency performance. Fairchild has evaluation boards to use as a guide for high frequency layout and to aid in device testing and characterization. Follow the steps below as a basis for high frequency layout:

- Include 6.8μF and 0.01μF ceramic capacitors
- Place the 6.8μF capacitor within 0.75 inches of the power pin
- Place the 0.01μF capacitor within 0.1 inches of the power pin
- Remove the ground plane under and around the part, especially near the input and output pins to reduce parasitic capacitance
- Minimize all trace lengths to reduce series inductances

Refer to the evaluation board layouts shown in Figure 6 for more information.

When evaluating only one channel, complete the following on the unused channel

1. Ground the non-inverting input
2. Short the output to the inverting input

**Evaluation Board Information**

The following evaluation boards are available to aid in the testing and layout of this device:

Eval Board	Description	Products
KEB006	Dual Channel, Dual Supply 8 lead SOIC	KM4211IC8
KEB010	Dual Channel, Dual Supply 8 lead MSOP	KM4211IM8

Evaluation board schematics and layouts are shown in Figure 5 and Figure 6.

The KEB006 evaluation board is built for dual supply operation. Follow these steps to use the board in a single supply application:

1. Short -Vs to ground
2. Use C3 and C4, if the -Vs pin of the KM4111 or KM4121 is not directly connected to the ground plane.

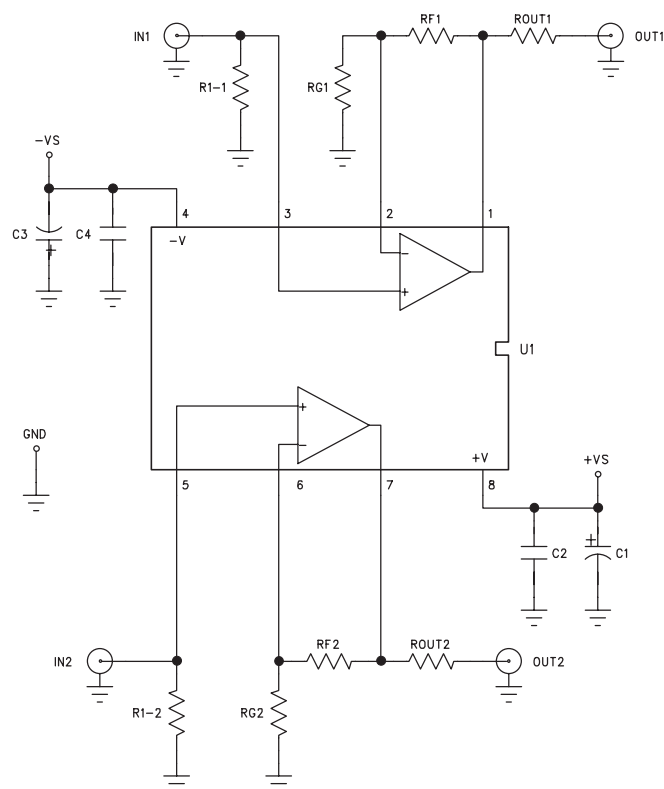

Figure 5: Evaluation Board Schematic

KM4211 Evaluation Board Layout

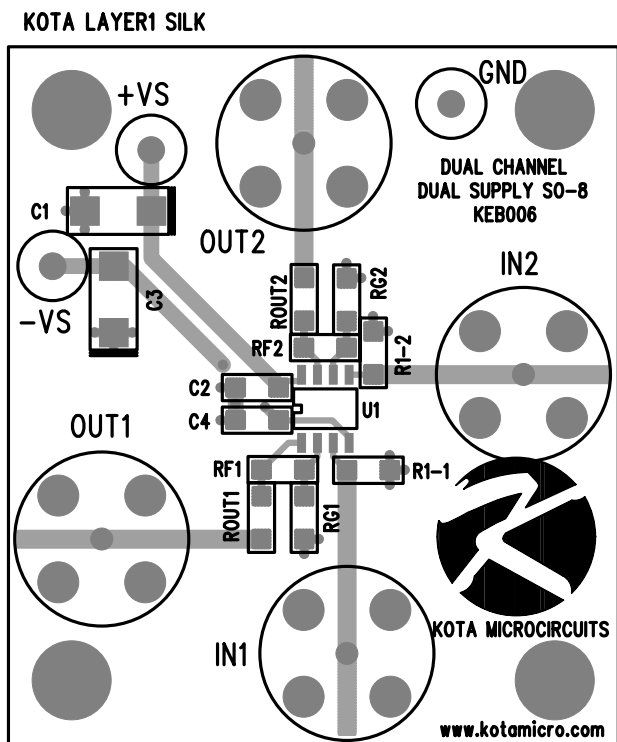

Figure 6a: KEB006 (top side)

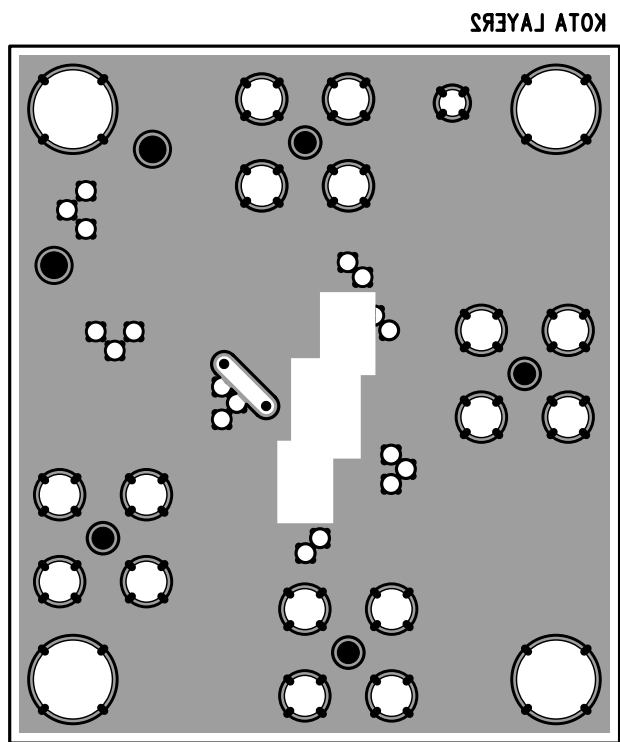

Figure 6b: KEB006 (bottom side)

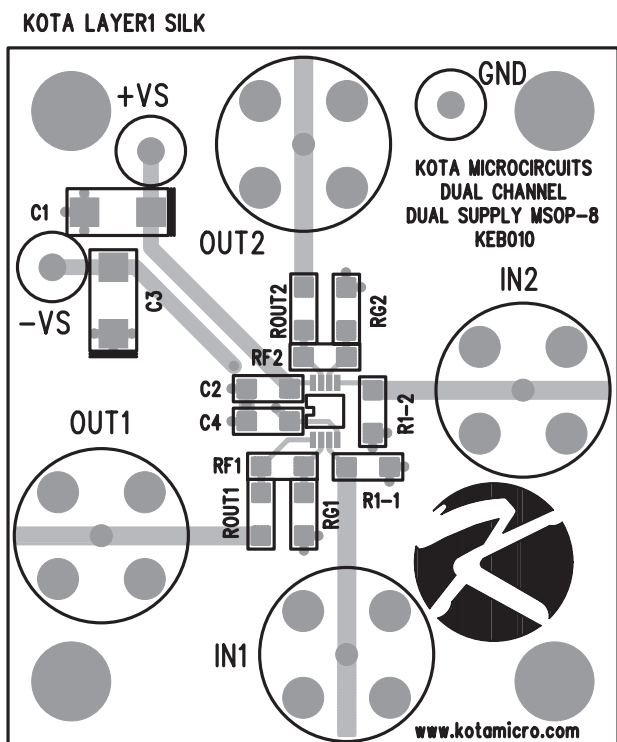

Figure 6c: KEB010 (top side)

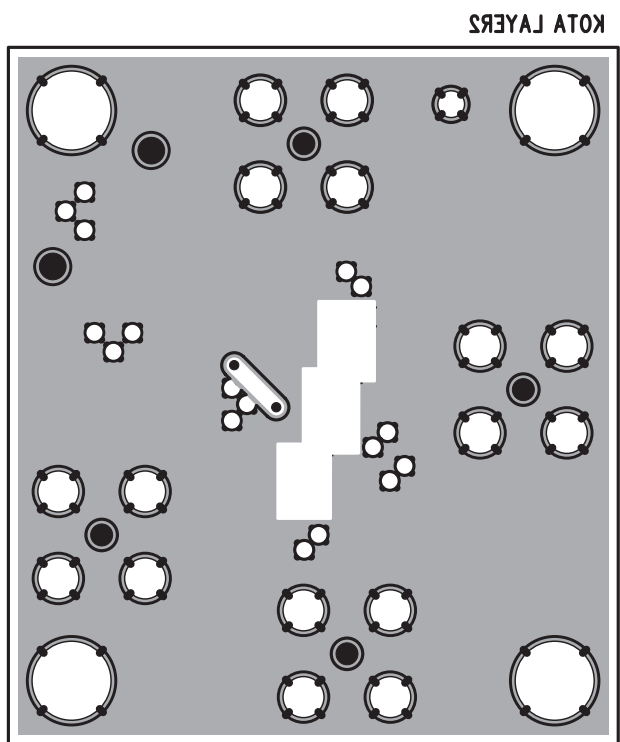
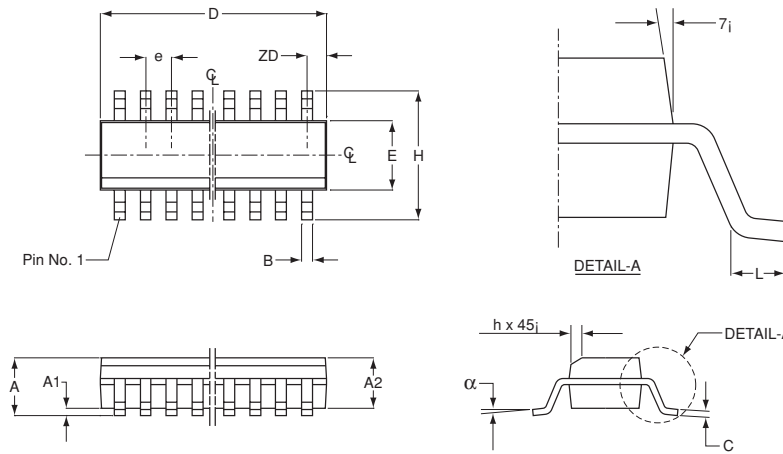

Figure 6d: KEB010 (bottom side)



# KM4211 Package Dimensions

## SOIC



SOIC-8		
SYMBOL	MIN	MAX
A1	0.10	0.25
B	0.36	0.46
C	0.19	0.25
D	4.80	4.98
E	3.81	3.99
e	1.27 BSC	
H	5.80	6.20
h	0.25	0.50
L	0.41	1.27
A	1.52	1.72
	0°	8°
ZD	0.53 ref	
A2	1.37	1.57

**NOTE:**

- All dimensions are in millimeters.
- Lead coplanarity should be 0 to 0.10mm (.004") max.
- Package surface finishing:
  - Top: matte (charmillies #18-30).
  - All sides: matte (charmillies #18-30).
  - Bottom: smooth or matte (charmillies #18-30).
- All dimensions excluding mold flashes and end flash from the package body shall not exceed 0.152mm (.006) per side(d).

## MSOP

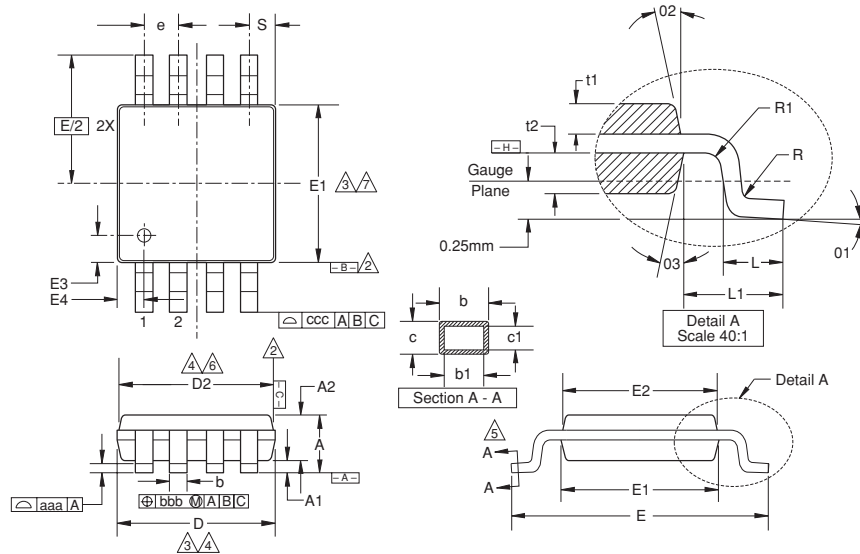

MSOP-8		
SYMBOL	MIN	MAX
A	1.10	-
A1	0.10	±0.05
A2	0.86	±0.08
D	3.00	±0.10
D2	2.95	±0.10
E	4.90	±0.15
E1	3.00	±0.10
E2	2.95	±0.10
E3	0.51	±0.13
E4	0.51	±0.13
R	0.15	+0.15/-0.06
R1	0.15	+0.15/-0.06
t1	0.31	±0.08
t2	0.41	±0.08
b	0.33	+0.07/-0.08
b1	0.30	±0.05
c	0.18	±0.05
c1	0.15	+0.03/-0.02
01	3.0°	±3.0°
02	12.0°	±3.0°
03	12.0°	±3.0°
L	0.55	±0.15
L1	0.95 BSC	-
aaa	0.10	-
bbb	0.08	-
ccc	0.25	-
e	0.65 BSC	-
S	0.525 BSC	-

**NOTE:**

- All dimensions are in millimeters (angle in degrees), unless otherwise specified.
- Datums  $\square B \square$  and  $\square C \square$  to be determined at datum plane  $\square H \square$ .
- Dimensions "D" and "E1" are to be determined at datum  $\square H \square$ .
- Dimensions "D2" and "E2" are for top package and dimensions "D" and "E1" are for bottom package.
- Cross sections A - A to be determined at 0.13 to 0.25mm from the leadtip.
- Dimension "D" and "D2" does not include mold flash, protrusion or gate burrs.
- Dimension "E1" and "E2" does not include interlead flash or protrusion.

## Ordering Information

Model	Part Number	Package	Container	Pack Qty
KM4211	KM4211IC8	SOIC-8	Rail	95
KM4211	KM4211IC8TR3	SOIC-8	Reel	2500
KM4211	KM4211IM8	MSOP-8	Rail	50
KM4211	KM4211IM8TR3	MSOP-8	Reel	4000

Temperature range for all parts: -40°C to +85°C

### DISCLAIMER

FAIRCHILD SEMICONDUCTOR RESERVES THE RIGHT TO MAKE CHANGES WITHOUT FURTHER NOTICES TO ANY PRODUCTS HEREIN TO IMPROVE RELIABILITY, FUNCTION OR DESIGN. FAIRCHILD DOES NOT ASSUME ANY LIABILITY ARISING OUT OF THE APPLICATION OR USE OF ANY PRODUCT OR CIRCUIT DESCRIBED HEREIN; NEITHER DOES IT CONVEY ANY LICENSE UNDER ITS PATENT RIGHTS, NOR THE RIGHTS OF OTHERS.

### LIFE SUPPORT POLICY

FAIRCHILD'S PRODUCTS ARE NOT AUTHORIZED FOR USE AS CRITICAL COMPONENTS IN LIFE SUPPORT DEVICES OR SYSTEMS WITHOUT THE EXPRESS WRITTEN APPROVAL OF THE PRESIDENT OF FAIRCHILD SEMICONDUCTOR CORPORATION. As used herein:

1. Life support devices or systems are devices or systems which, (a) are intended for surgical implant into the body, or (b) support or sustain life, and (c) whose failure to perform when properly used in accordance with instructions for use provided in the labeling, can be reasonably expected to result in a significant injury of the user.
2. A critical component in any component of a life support device or system whose failure to perform can be reasonably expected to cause the failure of the life support device or system, or to affect its safety or effectiveness.