

Half Controlled Single Phase Rectifier Bridge with Freewheeling Diode

$I_{dAVM} = 40 \text{ A}$
 $V_{RRM} = 800-1600 \text{ V}$

| V_{RSM} V_{DSM} V | V_{RRM} V_{DRM} V | Type |
|-----------------------------|-----------------------------|--------------|
| 900 | 800 | VHF 36-08io5 |
| 1300 | 1200 | VHF 36-12io5 |
| 1500 | 1400 | VHF 36-14io5 |
| 1700 | 1600 | VHF 36-16io5 |

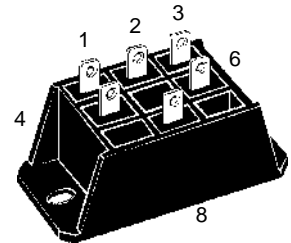
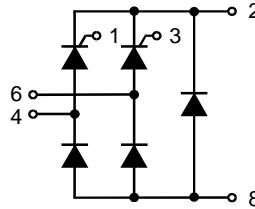

| Symbol | Test Conditions | Maximum Ratings |
|-------------------------|--|---|
| I_{dAV} | $T_K = 85^\circ\text{C}$, module | 36 A |
| I_{dAVM} ① | module | 40 A |
| I_{FRMS} , I_{TRMS} | per leg | 28 A |
| I_{FSM} , I_{TSM} | $T_{VJ} = 45^\circ\text{C}$; $V_R = 0 \text{ V}$ | $t = 10 \text{ ms}$ (50 Hz), sine 320 A $t = 8.3 \text{ ms}$ (60 Hz), sine 350 A |
| | $T_{VJ} = T_{VJM}$ $V_R = 0 \text{ V}$ | $t = 10 \text{ ms}$ (50 Hz), sine 280 A $t = 8.3 \text{ ms}$ (60 Hz), sine 310 A |
| I^2t | $T_{VJ} = 45^\circ\text{C}$ $V_R = 0 \text{ V}$ | $t = 10 \text{ ms}$ (50 Hz), sine 500 A ² s $t = 8.3 \text{ ms}$ (60 Hz), sine 520 A ² s |
| | $T_{VJ} = T_{VJM}$ $V_R = 0 \text{ V}$ | $t = 10 \text{ ms}$ (50 Hz), sine 390 A ² s $t = 8.3 \text{ ms}$ (60 Hz), sine 400 A ² s |
| $(di/dt)_{cr}$ | $T_{VJ} = 125^\circ\text{C}$ $f = 50 \text{ Hz}$, $t_p = 200 \mu\text{s}$ $V_D = 2/3 V_{DRM}$ $I_G = 0.3 \text{ A}$, $di_G/dt = 0.3 \text{ A}/\mu\text{s}$ | repetitive, $I_T = 50 \text{ A}$ 150 A/ μs |
| | | non repetitive, $I_T = 1/2 \cdot I_{dAV}$ 500 A/ μs |
| $(dv/dt)_{cr}$ | $T_{VJ} = T_{VJM}$; $V_{DR} = 2/3 V_{DRM}$ $R_{GK} = \infty$; method 1 (linear voltage rise) | 1000 V/ μs |
| V_{RGM} | | 10 V |
| P_{GM} | $T_{VJ} = T_{VJM}$ $I_T = I_{TAVM}$ | $t_p = 30 \mu\text{s}$ $\leq 10 \text{ W}$ |
| | | $t_p = 500 \mu\text{s}$ $\leq 5 \text{ W}$ |
| | | $t_p = 10 \text{ ms}$ $\leq 1 \text{ W}$ |
| P_{GAVM} | | 0.5 W |
| T_{VJ} | | -40...+125 °C |
| T_{VJM} | | 125 °C |
| T_{stg} | | -40...+125 °C |
| V_{ISOL} | 50/60 Hz, RMS | $t = 1 \text{ min}$ 3000 V~ $t = 1 \text{ s}$ 3600 V~ |
| | $I_{ISOL} \leq 1 \text{ mA}$ | |
| M_d | Mounting torque | (M5) 2-2.5 Nm (10-32 UNF) 18-22 lb.in. |
| | | 50 g |

Features

- Package with DCB ceramic base plate
- Isolation voltage 3600 V~
- Planar passivated chips
- ¼" fast-on terminals
- UL registered E 72873

Applications

- Supply for DC power equipment
- DC motor control

Advantages

- Easy to mount with two screws
- Space and weight savings
- Improved temperature and power cycling

Dimensions in mm (1 mm = 0.0394")

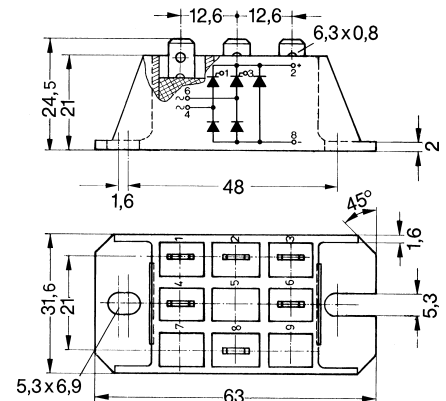

Data according to IEC 60747 and refer to a single thyristor/diode unless otherwise stated.

① for resistive load

IXYS reserves the right to change limits, test conditions and dimensions.

| Symbol | Test Conditions | Characteristic Values |
|------------|--|---|
| I_R, I_D | $V_R = V_{RRM}; V_D = V_{DRM}$ $T_{VJ} = T_{VJM}$ $T_{VJ} = 25^\circ\text{C}$ | ≤ 5 mA ≤ 0.3 mA |
| V_T, V_F | $I_T, I_F = 45$ A; $T_{VJ} = 25^\circ\text{C}$ | ≤ 1.45 V |
| V_{T0} | For power-loss calculations only ($T_{VJ} = 125^\circ\text{C}$) | 0.85 V |
| r_T | | 13 m Ω |
| V_{GT} | $V_D = 6$ V; $T_{VJ} = 25^\circ\text{C}$ $T_{VJ} = -40^\circ\text{C}$ | ≤ 1.0 V ≤ 1.2 V |
| I_{GT} | $V_D = 6$ V; $T_{VJ} = 25^\circ\text{C}$ $T_{VJ} = -40^\circ\text{C}$ $T_{VJ} = 125^\circ\text{C}$ | ≤ 65 mA ≤ 80 mA ≤ 50 mA |
| V_{GD} | $T_{VJ} = T_{VJM}; V_D = 2/3 V_{DRM}$ | ≤ 0.2 V |
| I_{GD} | $T_{VJ} = T_{VJM}; V_D = 2/3 V_{DRM}$ | ≤ 5 mA |
| I_L | $I_G = 0.3$ A; $t_g = 30$ μs ; $di_G/dt = 0.3$ A/ μs ; $T_{VJ} = 25^\circ\text{C}$ $T_{VJ} = -40^\circ\text{C}$ $T_{VJ} = 125^\circ\text{C}$ | ≤ 150 mA ≤ 200 mA ≤ 100 mA |
| I_H | $T_{VJ} = 25^\circ\text{C}; V_D = 6$ V; $R_{GK} = \infty$ | ≤ 100 mA |
| t_{gd} | $T_{VJ} = 25^\circ\text{C}; V_D = 1/2 V_{DRM}$ $I_G = 0.3$ A; $di_G/dt = 0.3$ A/ μs | ≤ 2 μs |
| t_q | $T_{VJ} = 125^\circ\text{C}; I_T = 15$ A, $t_p = 300$ μs , $V_R = 100$ V | typ. 150 μs |
| Q_r | $di/dt = -10$ A/ μs , $dv/dt = 20$ V/ μs , $V_D = 2/3 V_{DRM}$ | 75 μC |
| R_{thJC} | per thyristor (diode); DC current | 1.15 K/W |
| | per module | 0.29 K/W |
| R_{thJK} | per thyristor (diode); DC current | 1.55 K/W |
| | per module | 0.39 K/W |
| d_s | Creeping distance on surface | 12.6 mm |
| d_A | Creepage distance in air | 6.3 mm |
| a | Max. allowable acceleration | 50 m/s ² |

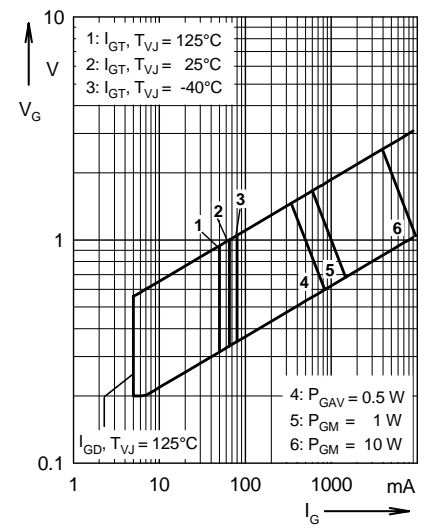
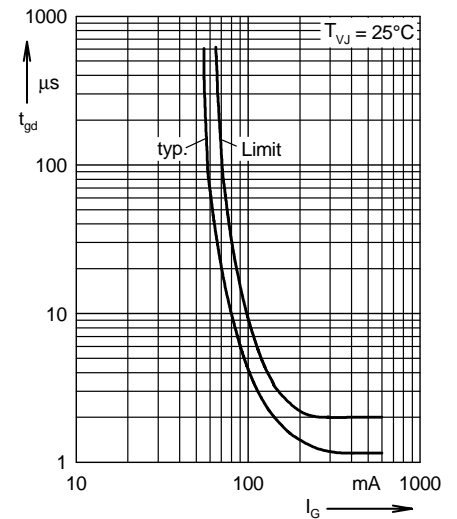

Fig. 1 Gate trigger range

 Fig. 2 Gate controlled delay time t_{gd}

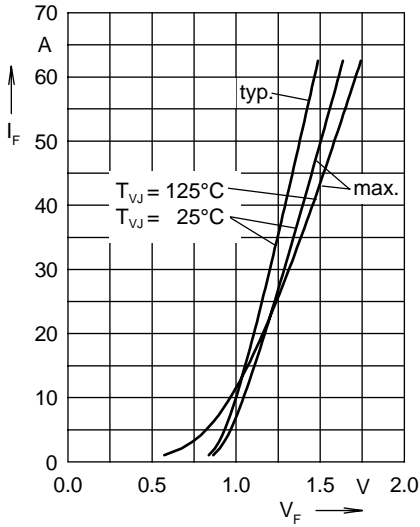

Fig. 3 Forward current versus voltage drop per diode

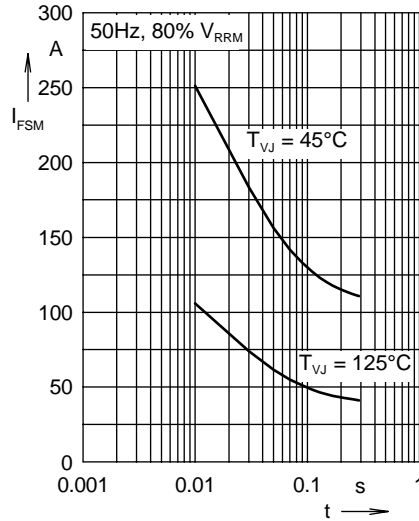

Fig. 4 Surge overload current

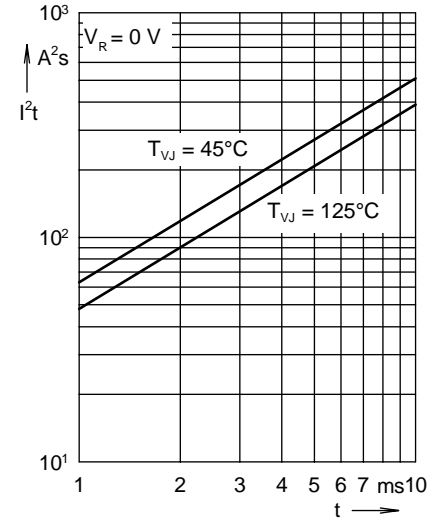

Fig. 5 I^2t versus time per diode

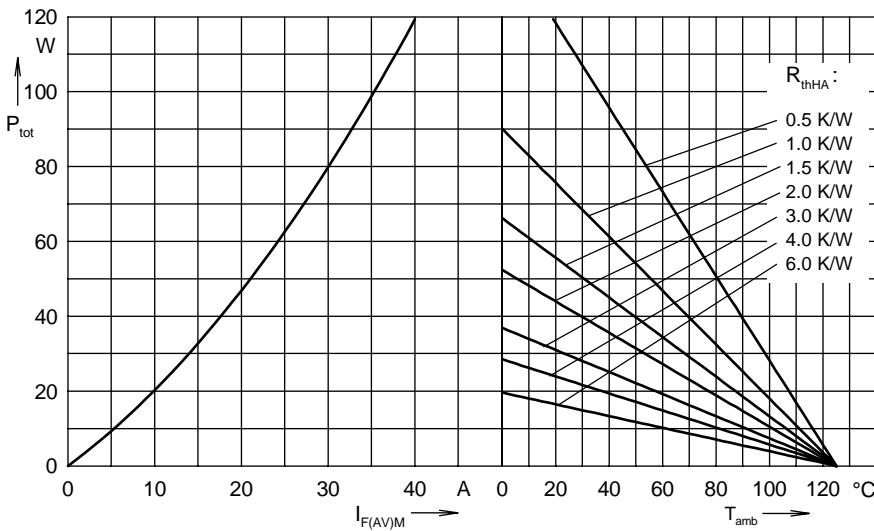

Fig. 6 Power dissipation versus direct output current and ambient temperature

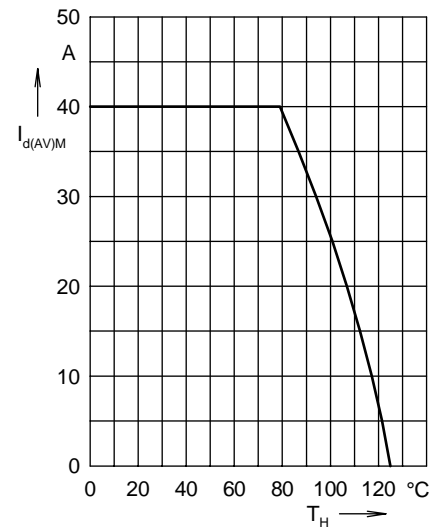

Fig. 7 Max. forward current versus heatsink temperature

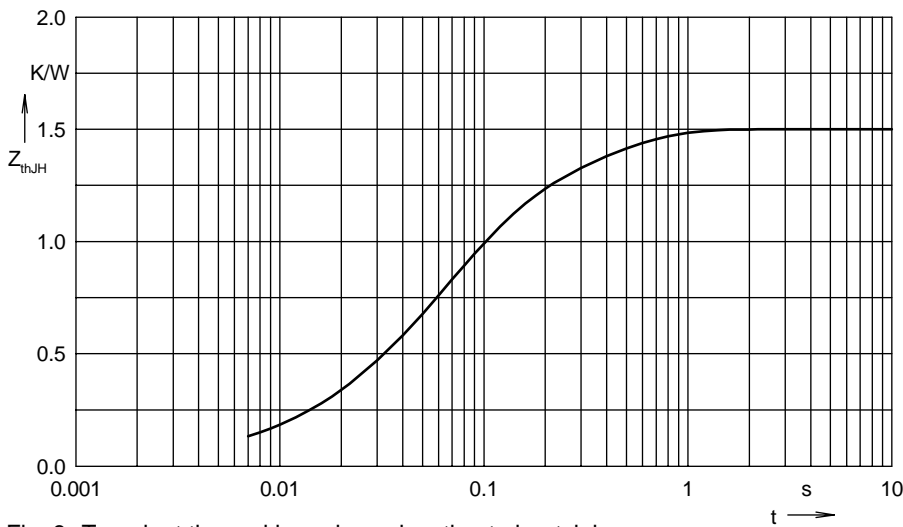

Fig. 8 Transient thermal impedance junction to heatsink

Constants for Z_{thJH} calculation:

| i | R_{thi} (K/W) | t_i (s) |
|---|-----------------|-----------|
| 1 | 0.005 | 0.008 |
| 2 | 0.2 | 0.05 |
| 3 | 0.875 | 0.06 |
| 4 | 0.47 | 0.25 |

This datasheet has been downloaded from:

www.DatasheetCatalog.com

Datasheets for electronic components.