

# PM200DVA120

FLAT-BASE TYPE  
INSULATED PACKAGE

## PM200DVA120



### FEATURE

- 1φ 200A, 1200V Current-sense IGBT for 20kHz switching
  - Monolithic gate drive & protection logic
  - Detection, protection & status indication circuits for over-current, short-circuit, over-temperature & under-voltage (P-Fo available from upper leg devices)
  - Acoustic noise-less 37kW class inverter application
  - UL Recognized
- Yellow Card No. E80276(N)  
File No. E80271

## APPLICATION

General purpose inverter, servo drives and other motor controls

## PACKAGE OUTLINES

Dimensions in mm

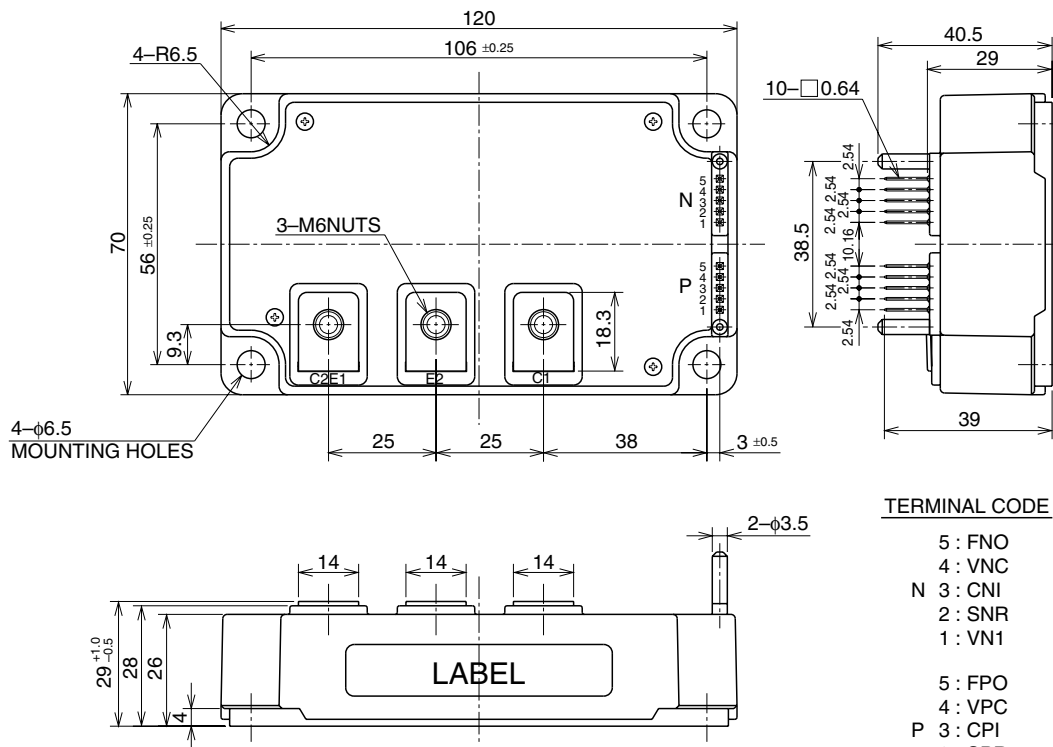

### TERMINAL CODE

- |     |       |
|-----|-------|
| 5   | : FNO |
| 4   | : VNC |
| N 3 | : CNI |
| 2   | : SNR |
| 1   | : VN1 |
|     |       |
| 5   | : FPO |
| 4   | : VPC |
| P 3 | : CPI |
| 2   | : SPR |
| 1   | : VP1 |



# PM200DVA120

FLAT-BASE TYPE  
INSULATED PACKAGE

## TOTAL SYSTEM

Symbol	Parameter	Condition	Ratings	Unit
VCC(PROT)	Supply Voltage Protected by SC	V <sub>D</sub> = 13.5 ~ 16.5V, Inverter Part, T <sub>j</sub> = 125°C Start	800	V
VCC(surge)	Supply Voltage (Surge)	Applied between : C1-E2, Surge value or without switching	1000	V
T <sub>c</sub>	Module Case Operating Temperature	(Note-1)	-20 ~ +100	°C
T <sub>stg</sub>	Storage Temperature		-40 ~ +125	°C
V <sub>iso</sub>	Isolation Voltage	60Hz, Sinusoidal, Charged part to Base, AC 1 min.	2500	V <sub>rms</sub>

(Note-1) T<sub>c</sub> measurement point is below. (3mm depth at the center of the side of base plate)

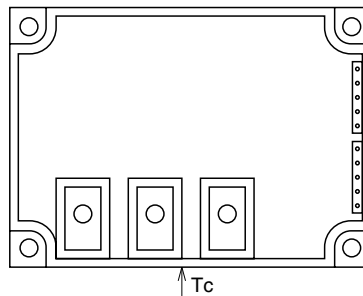

## ELECTRICAL CHARACTERISTICS (T<sub>j</sub> = 25°C, unless otherwise noted)

### INVERTER PART

Symbol	Parameter	Test Condition	Limits			Unit	
			Min.	Typ.	Max.		
V <sub>CE(sat)</sub>	Collector-Emitter Saturation Voltage	V <sub>D</sub> = 15V, I <sub>c</sub> = 200A	—	2.65	3.30	V	
		V <sub>CIN</sub> = 0V	—	2.60	3.25		
V <sub>EC</sub>	FWDI Forward Voltage	-I <sub>c</sub> = 200A, V <sub>D</sub> = 15V, V <sub>CIN</sub> = 5V	—	2.50	3.50	V	
t <sub>on</sub>	Switching Time	V <sub>D</sub> = 15V, V <sub>CIN</sub> = 0V↔5V V <sub>CC</sub> = 600V, I <sub>c</sub> = 200A T <sub>j</sub> = 125°C Inductive Load (upper and lower arm)	0.4	0.9	2.3	μs	
t <sub>tr</sub>			—	0.2	0.3		
t <sub>c(on)</sub>			—	0.4	1.0		
t <sub>off</sub>			—	2.4	3.4		
t <sub>c(off)</sub>			—	0.7	1.2		
I <sub>CES</sub>	Collector-Emitter Cutoff Current	V <sub>CE</sub> = V <sub>CES</sub> , V <sub>CIN</sub> = 15V	T <sub>j</sub> = 25°C	—	—	1	mA
			T <sub>j</sub> = 125°C	—	—	10	

### CONTROL PART

Symbol	Parameter	Test Condition	Limits			Unit	
			Min.	Typ.	Max.		
I <sub>D</sub>	Circuit Current	V <sub>D</sub> = 15V, V <sub>CIN</sub> = 5V	V <sub>N1</sub> -V <sub>NC</sub>	—	27	38	mA
			V <sub>P1</sub> -V <sub>PC</sub>	—	27	38	
V <sub>th(ON)</sub>	Input ON Threshold Voltage	Applied between : C <sub>P1</sub> -V <sub>PC</sub> , C <sub>N1</sub> -V <sub>NC</sub>	1.2	1.5	1.8	V	
V <sub>th(OFF)</sub>	Input OFF Threshold Voltage		1.7	2.0	2.3		
SC	Short Circuit Trip Level	-20 ≤ T <sub>j</sub> ≤ 125°C, V <sub>D</sub> = 15V	240	—	—	A	
t <sub>off(SC)</sub>	Short Circuit Current Delay Time	V <sub>D</sub> = 15V	—	10	—	μs	
OT	Over Temperature Protection (Lower-arms only)	Base-plate Temperature detection, V <sub>D</sub> = 15V	Trip level	111	118	125	°C
			Reset level	—	100	—	
UV	Supply Circuit Under-Voltage Protection	-20 ≤ T <sub>j</sub> ≤ 125°C	Trip level	11.5	12.0	12.5	V
			Reset level	—	12.5	—	
I <sub>FO(H)</sub>	Fault Output Current	V <sub>D</sub> = 15V, V <sub>FO</sub> = 15V	(Note-2)	—	—	0.01	mA
I <sub>FO(L)</sub>			(Note-2)	—	10	15	
t <sub>FO</sub>	Minimum Fault Output Pulse Width	V <sub>D</sub> = 15V	(Note-2)	1.0	1.8	—	ms
V <sub>SXR</sub>	SXR Terminal Output Voltage	-20 ≤ T <sub>j</sub> ≤ 125°C, R <sub>in</sub> = 6.8kΩ	4.5	5.1	5.6	V	

(Note-2) Fault output is given only when the internal SC, OT & UV protection.  
Fault output of OT protection operate by lower arm  
Fault output of OT, UV protection given pulse while over level.

**PM200DVA120****FLAT-BASE TYPE  
INSULATED PACKAGE****THERMAL RESISTANCES**

Symbol	Parameter	Test Condition	Limits			Unit
			Min.	Typ.	Max.	
R <sub>th(j-c)Q</sub>	Junction to case Thermal Resistances	Inverter IGBT part (per 1/2 module)	—	—	0.121	°C/W
R <sub>th(j-c)F</sub>		Inverter FWDi part (per 1/2 module)	—	—	0.18	
R <sub>th(c-f)</sub>	Contact Thermal Resistance	Case to fin, Thermal grease applied (per 1/2 module)	—	—	0.075	

**MECHANICAL RATINGS AND CHARACTERISTICS**

Symbol	Parameter	Test Condition	Limits			Unit
			Min.	Typ.	Max.	
—	Mounting torque	Mounting part screw : M6	3.92	4.90	5.88	N • m
—	Mounting torque	Main terminal screw : M6	3.92	4.90	5.88	N • m
—	Weight		—	510	—	g

**RECOMMENDED CONDITIONS FOR USE**

Symbol	Parameter	Test Condition	Recommended value	Unit
V <sub>CC</sub>	Supply Voltage	Applied across C1-E2 terminals	≤ 800	V
V <sub>D</sub>	Control Supply Voltage	Applied between : VP1-VPC, VN1-VNC (Note-3)	15 ± 1.5	V
V <sub>CIN(ON)</sub>	Input ON Voltage	Applied between : CPI-VPC, CNI-VNC	≤ 0.8	V
V <sub>CIN(OFF)</sub>	Input OFF Voltage		≥ 4.0	
t <sub>dead</sub>	Arm Shoot-through Blocking Time	For IPM's each input signals	≥ 3.5	μs
f <sub>PWM</sub>	PWM Input Frequency	Using Application Circuit input signal of IPM, 3φ Sinusoidal PWM VVVF inverter	≤ 20	kHz

(Note-3) With ripple satisfying the following conditions dv/dt swing ≤ ±5V/μs, Variation ≤ 2V peak to peak

# PM200DVA120

FLAT-BASE TYPE  
INSULATED PACKAGE

## PERFORMANCE CURVES

**OUTPUT CHARACTERISTICS (TYPICAL)**

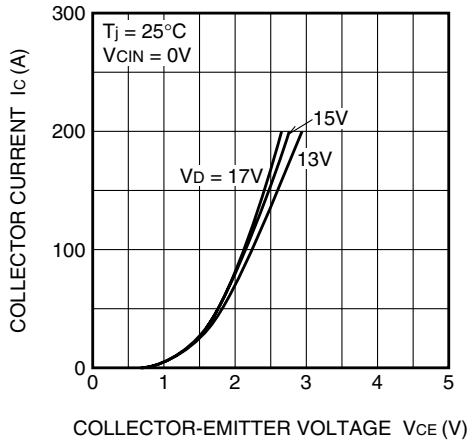

**COLLECTOR-EMITTER SATURATION VOLTAGE CHARACTERISTICS (TYPICAL)**

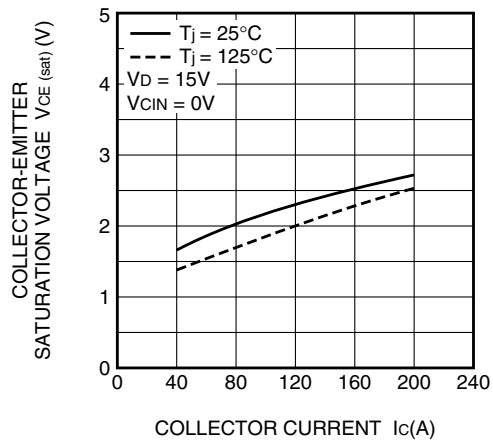

**COLLECTOR-EMITTER SATURATION VOLTAGE CHARACTERISTICS (TYPICAL)**

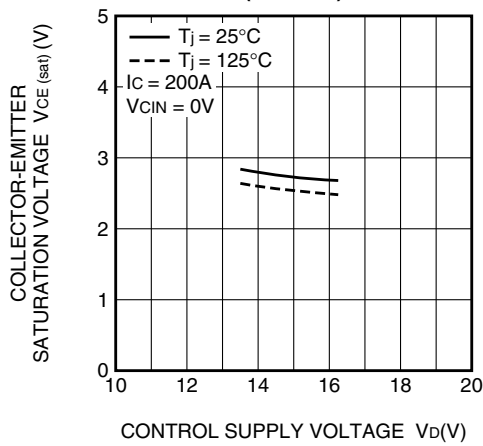

**SWITCHING CHARACTERISTICS (TYPICAL)**

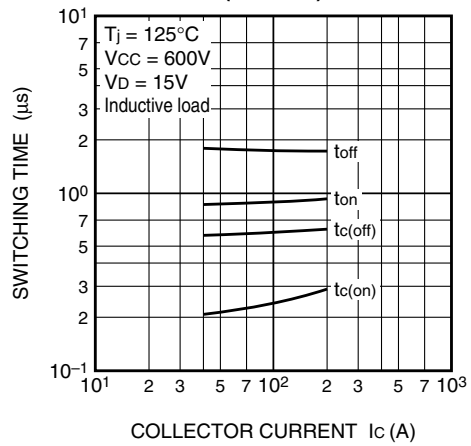

**DIODE FORWARD CHARACTERISTICS (TYPICAL)**

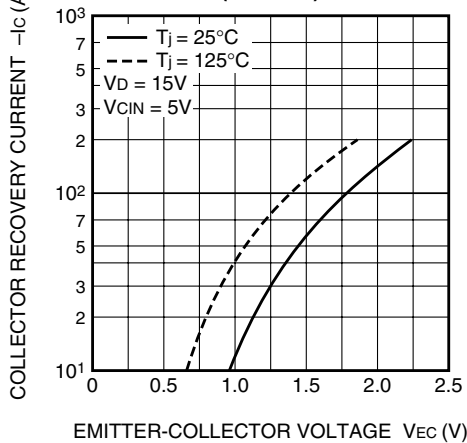

**DIODE REVERSE RECOVERY CHARACTERISTICS (TYPICAL)**

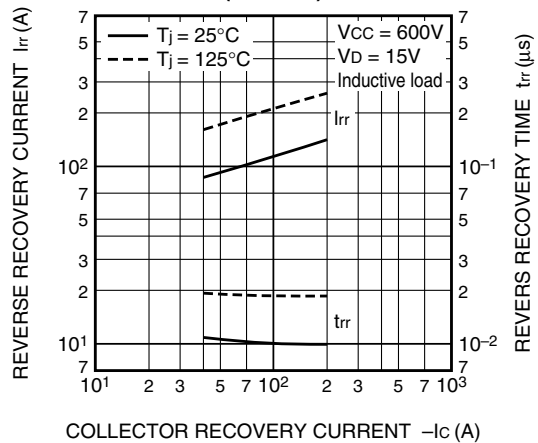

# PM200DVA120

FLAT-BASE TYPE  
INSULATED PACKAGE

