



## Wireless Temperature Sensors

### General Description

The ALTA Wireless Temperature Sensor uses a type NTC thermistor to measure temperature.

- Accurate to  $\pm 1^{\circ}\text{C}$  ( $\pm 1.8^{\circ}\text{F}$ )
- Increased accuracy by user calibration to  $\pm 0.25^{\circ}\text{C}$  ( $\pm 0.45^{\circ}\text{F}$ )

### Principle of Operation

The ALTA Wireless Temperature Sensor outputs the ambient temperature in degrees Fahrenheit. It is programmed to sleep for a user-given time interval (heartbeat) and then wakeup, send power to the NTC Thermistor and wait for it to stabilize, and convert the analog data, mathematically compute the temperature and transmit the data to the gateway. To stay within the abilities of the processor, the temperature is computed off a data table provided by the manufacturer. To reduce error, a variable resistor configuration is implemented over specified temperature ranges.

### Example Applications

- Ambient temperature monitoring
- Environmental monitoring
- Smart machines & smart structures
- HVAC operation & testing
- Data center monitoring
- Many additional applications

### Features of Monnit ALTA Sensors

- Wireless range of 1,200+ feet through 12+ walls \*
- Frequency-Hopping Spread Spectrum (FHSS)
- Improved interference immunity
- Improved power management for longer battery life \*\* (12+ years on AA batteries)
- Encrypt-RF® Security (Diffie-Hellman Key Exchange + AES-128 CBC for sensor data messages)
- Onboard data memory stores up to 512 readings per sensor:
  - 10-minute heartbeats = 3.5 days
  - 2-hour heartbeats = 42 days
- Over-the-air updates (future proof)
- Free iMonnit basic online wireless sensor monitoring and notification system to configure sensors, view data and set alerts via SMS text and email

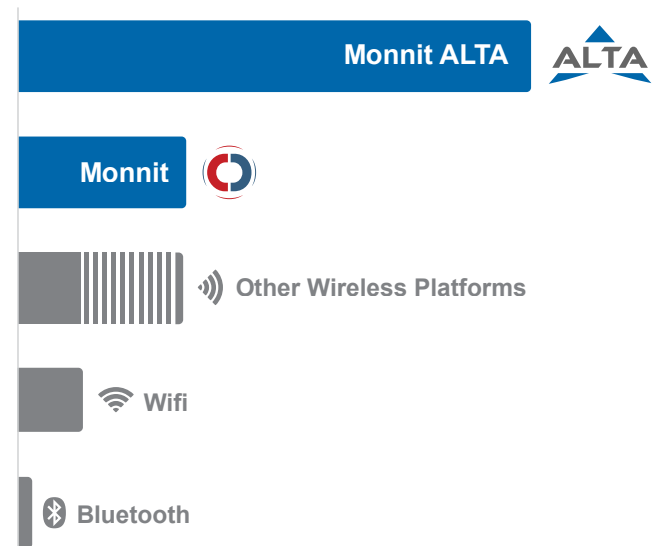

- \* Actual range may vary depending on environment.
- \*\* Battery life is determined by sensor reporting frequency and other variables. Other power options are also available.

### Wireless Range Comparison

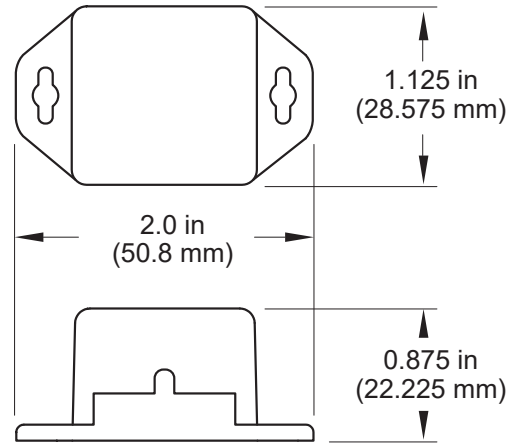



## ALTA Commercial Coin Cell Wireless Temperature Sensor | Technical Specifications

Supply voltage	2.0–3.8 VDC *
Current consumption	0.2 $\mu$ A (sleep mode), 0.7 $\mu$ A (RTC sleep), 570 $\mu$ A (MCU idle), 2.5 mA (MCU active), 5.5 mA (radio RX mode), 22.6 mA (radio TX mode)
Operating temperature range (board circuitry and coin cell)	-7°C to +60°C (20°F to +140°F) **
Optimal battery temperature range (coin cell)	+10°C to +50°C (+50°F to +122°F)
Thermistor temperature range (thermistor only)	-40°C to +125°C (-40°F to +257°F) (Limited to main-unit circuitry, -7°C to +60°C unless wire leads are being used.)
Accuracy @ 25°C	+/- 1% (1° C or 1.8° F)
User-calibrated accuracy	+/- 0.25° C ( $\pm$ 0.45° F)
Time constant @ 25°C	30 sec
Integrated memory	Up to 512 sensor messages
Wireless range	1,200+ ft non-line-of-sight
Security	Encrypt-RF® (256-bit key exchange and AES-128 CTR)
Weight	0.7 ounces
Certifications	  Industry Canada 900 MHz product; FCC ID: ZTL-G2SC1 and IC: 9794A-G2SC1. 868 and 433 MHz product tested and found to comply with: EN 300 220-2 V3.1.1 (2017-02), EN 300 220-2 V3.1.1 (2017-02) and EN 60950

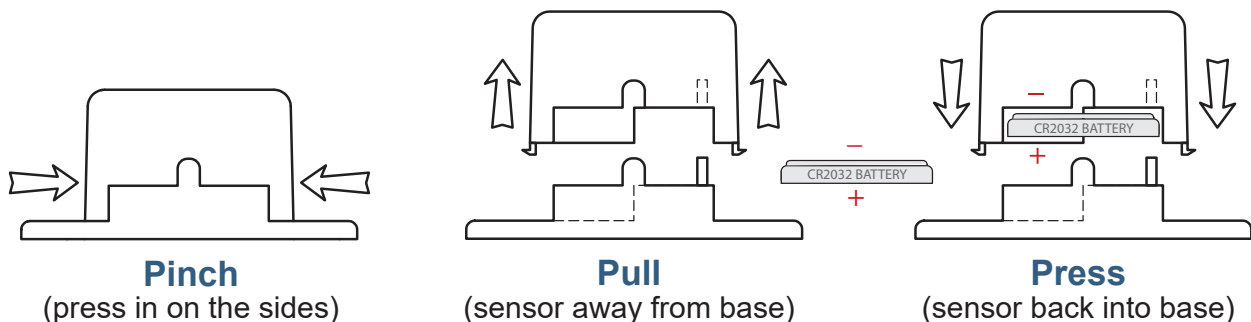

\* Hardware cannot withstand negative voltage. Please take care when connecting a power device.

## PinchPower™ Enclosures





## ALTA Commercial AA Wireless Temperature Sensor | Technical Specifications

Supply voltage	2.0–3.8 VDC (3.0–3.8 VDC using power supply) *
Current consumption	0.2 $\mu$ A (sleep mode), 0.7 $\mu$ A (RTC sleep), 570 $\mu$ A (MCU idle), 2.5 mA (MCU active), 5.5 mA (radio RX mode), 22.6 mA (radio TX mode)
Operating temperature range (board circuitry and batteries)	-18°C to 55°C (0°F to 130°F) using alkaline -40°C to 85°C (-40°F to 185°F) using lithium **
Optimal battery temperature range (AA)	+10°C to +50°C (+50°F to +122°F)
Thermistor temperature range (thermistor only)	-40°C to +125°C (-40°F to +257°F) (Limited to main-unit circuitry, -7°C to +60°C unless thermistor leads are being used.)
Accuracy @ 25°C	+/- 1% (1° C or 1.8° F)
User-calibrated accuracy	+/- 0.25° C ( $\pm$ 0.45° F)
Time constant @ 25°C	15 sec max
Integrated memory	Up to 512 sensor messages
Wireless range	1,200+ ft non-line-of-sight
Security	Encrypt-RF® (256-bit key exchange and AES-128 CTR)
Weight	3.7 ounces
Certifications	<div style="display: flex; align-items: center; gap: 10px;">   <span>Industry Canada</span> </div> 900 MHz product; FCC ID: ZTL-G2SC1 and IC: 9794A-G2SC1. 868 and 433 MHz product tested and found to comply with: EN 300 220-2 V3.1.1 (2017-02), EN 300 220-2 V3.1.1 (2017-02) and EN 60950

\* Hardware cannot withstand negative voltage. Please take care when connecting a power device.

## Power Options



The standard version of this sensor is powered by two replaceable 1.5 V AA sized batteries (included with purchase).

This sensor is also available with a line power option. The line powered version of this sensor has a barrel power connector allowing it to be powered by a standard 3.0–3.6 V power supply. The line powered version also uses two standard 1.5 V AA batteries as backup for uninterrupted operation in the event of line power outage.

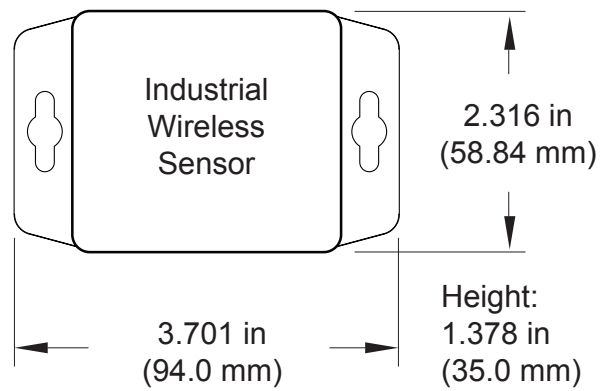
Power options must be selected at time of purchase, as the internal hardware of the sensor must be changed to support the selected power requirements.



## ALTA Industrial Wireless Temperature Sensor | Technical Specifications

Supply voltage	2.0–3.8 VDC (3.0–3.8 VDC using power supply) *	
Current consumption	0.2 $\mu$ A (sleep mode), 0.7 $\mu$ A (RTC sleep), 570 $\mu$ A (MCU idle), 2.5 mA (MCU active), 5.5 mA (radio RX mode), 22.6 mA (radio TX mode)	
Operating temperature range (board circuitry and battery)	-40°C to +85°C (-40°F to +185°F)	
Included battery	Max temperature range	-40° to +85°C (-40° to +185°F)
	Capacity	1500 mAh
Optional solar feature	Solar panel	5VDC/30mA (53mm x 30mm)
	Charging temperature range	0° to 45°C (32° to 113°F)
	Max temperature range	-20° to 60°C (-4° to 140°F)
	Included rechargeable battery	600 mAh/>2000 charge cycles (80% of initial capacity)
	Solar efficiency	Optimized for high and low-light operation **
	Charging efficiency	40% ***
	Luminous sustainability	Minimum of 250 LUX ***
Thermistor temperature range (thermistor only)	-40°C to +125°C (-40°F to +257°F) (Limited to main-unit circuitry, -40°C to +85°C)	
Accuracy @ 25°C	+/- 1% (1° C or 1.8° F)	
User-calibrated accuracy	+/- 0.25° C ( $\pm$ 0.45° F)	
Time constant @ 25°C	30 sec	
Integrated memory	Up to 512 sensor messages	
Wireless range	1,200+ ft non-line-of-sight	
Security	Encrypt-RF® (256-bit key exchange and AES-128 CTR)	
Weight	4.7 ounces	
Enclosure rating	NEMA 1, 2, 4, 4x, 12 and 13 rated, sealed and weather proof	
UL rating	UL Listed to UL508-4x specifications (File E194432)	
Certifications	<div style="display: flex; align-items: center; gap: 10px;">   <span>Industry Canada</span> </div> 900 MHz product; FCC ID: ZTL-G2SC1 and IC: 9794A-G2SC1. 868 and 433 MHz product tested and found to comply with: EN 300 220-2 V3.1.1 (2017-02), EN 300 220-2 V3.1.1 (2017-02) and EN 60950	

\* Hardware cannot withstand negative voltage. Please take care when connecting a power device.

\*\* Light present 25% of day yields 125% of operating power to support 10-minute heartbeats.

\*\*\* Solar feature's energy harvesting circuitry works indoors with low light.

## Commercial Grade Sensors

Monnit commercial grade sensors are designed for applications in ordinary environments (normal room temperature, humidity and atmospheric pressure). Do not use these sensors under the following conditions as these factors can deteriorate the product characteristics and cause failures and burnout.

- Corrosive gas or deoxidizing gas: chlorine gas, hydrogen sulfide gas, ammonia gas, sulfuric acid gas, nitric oxides gas, etc.
- Volatile or flammable gas
- Dusty conditions
- Low-pressure or high-pressure environments
- Wet or excessively humid locations
- Places with salt water, oils chemical liquids or organic solvents
- Where there are excessively strong vibrations
- Other places where similar hazardous conditions exist

Use these products within the specified temperature range. Higher temperature may cause deterioration of the characteristics or the material quality.

## Industrial Grade Sensors | Type 1, 2, 4, 4X, 12 and 13 NEMA Rated Enclosure

Monnit's Industrial sensors are enclosed in reliable, weatherproof NEMA-rated enclosures. Our NEMA-rated enclosures are constructed for both indoor or outdoor use and protect the sensor circuitry against the ingress of solid foreign objects like dust as well as the damaging effects of water (rain, sleet, snow, splashing water, and hose-directed water).

- Safe from falling dirt
- Protects against wind-blown dust
- Protects against rain, sleet, snow, splashing water, and hose-directed water
- Increased level of corrosion resistance
- Will remain undamaged by ice formation on the enclosure



For more information about our products or to place an order, please contact our sales department at 801-561-5555.

Visit us on the web at [www.monnit.com](http://www.monnit.com).

Monnit Corporation  
3400 South West Temple  
Salt Lake City, UT 84115  
801-561-5555  
[www.monnit.com](http://www.monnit.com)