



## Glass Passivated Rectifier Diode Modules

**VRRM** 800 to 1800V  
**IFAV** 200 A

### Applications

- Non-controllable rectifiers for AC/AC converters
- Line rectifiers for transistorized AC motor controllers
- Field supply for DC motors

### Features

- Blocking voltage: 800 to 1800V
- Heat transfer through aluminum oxide ceramic isolated metal baseplate
- Glass passivated chip
- UL recognized applied for file no. E360040

### Circuit

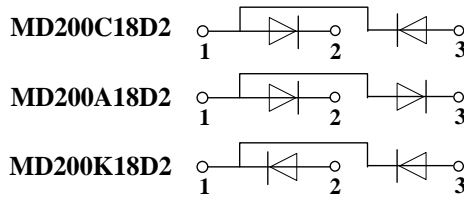

### Module Type

TYPE			VRRM	VRSM
MD200C08D2	MD200A08D2	MD200K08D2	800V	900V
MD200C12D2	MD200A12D2	MD200K12D2	1200V	1300V
MD200C16D2	MD200A16D2	MD200K16D2	1600V	1700V
MD200C18D2	MD200A18D2	MD200K18D2	1800V	1900V

### Maximum Ratings

Symbol	Conditions	Values	Units
IFAV	Single phase ,half wave 180° conduction Tc=95°C	200	A
IFSM	t=10mS Tvj =45°C	6800	A
	t=10mS Tvj =150°C	6000	A
i <sup>2</sup> t	t=10mS Tvj =45°C	231200	A <sup>2</sup> s
	t=10mS Tvj =150°C	180000	A <sup>2</sup> s
V <sub>isol</sub>	a.c.50HZ;r.m.s.;1min	3000	V
T <sub>vj</sub>		-40 to 150	°C
T <sub>stg</sub>		-40 to 125	°C
Mt	To terminals(M6)	5±15%	Nm
Ms	To heat sink(M6)	5±15%	Nm
Weight	Module (Approximately)	160	g

### Thermal Characteristics

Symbol	Conditions	Values	Units
R <sub>th(j-c)</sub>	Per diode	0.18	°C/W
R <sub>th(c-s)</sub>	Per Module	0.05	°C/W



## Electrical Characteristics

Symbol	Conditions	Values			Units
		Min.	Typ.	Max.	
$V_{FM}$	$T=25^{\circ}C$ $I_F=300A$	1	1.18	1.30	V
	$T=150^{\circ}C$ $I_F=300A$	1	1.16	1.22	V
$I_{RD}$	$T_{vj}=150^{\circ}C$ $V_{RD}=V_{RRM}$	—	—	9	mA
$r_f$	$T_J=25^{\circ}C$		1.13		m $\Omega$
	$T_J=150^{\circ}C$		1.4		m $\Omega$
$V_{fO}$	$T_J=25^{\circ}C$		0.84		V
	$T_J=150^{\circ}C$		0.74		V

## Performance Curves

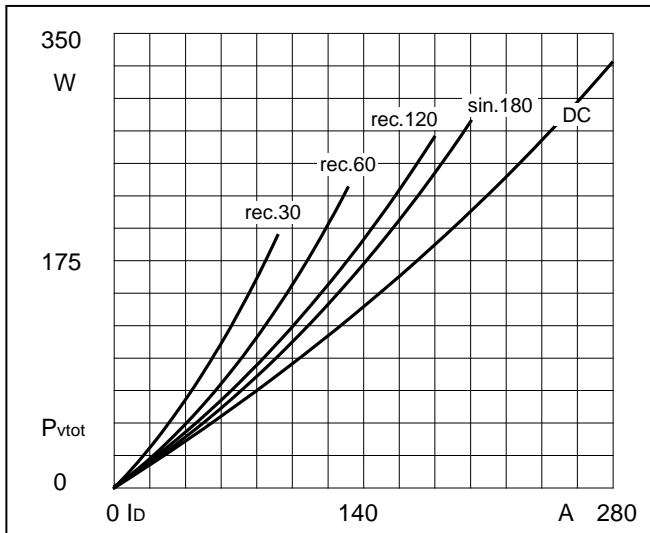

Fig1. Power dissipation

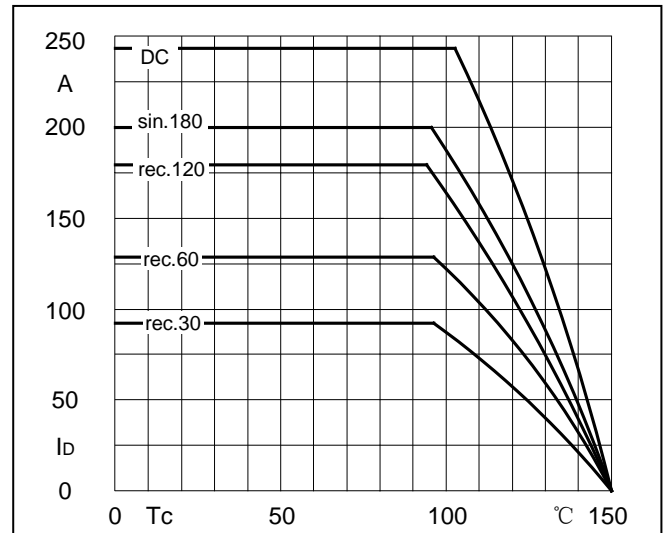

Fig2. Forward Current Derating Curve

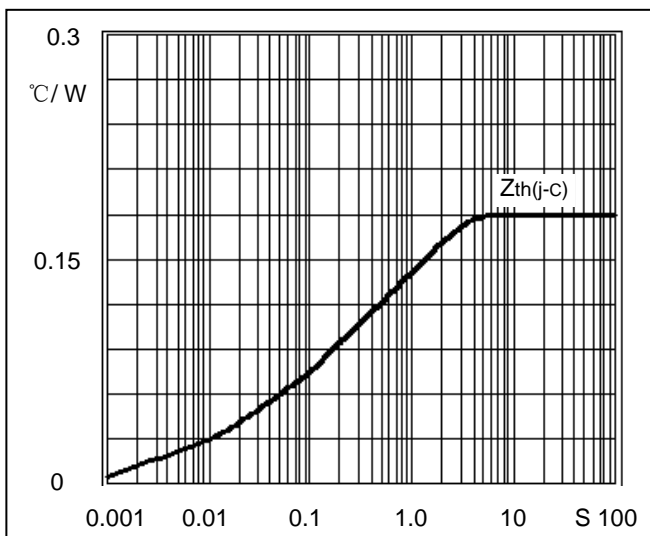

Fig3. Transient thermal impedance

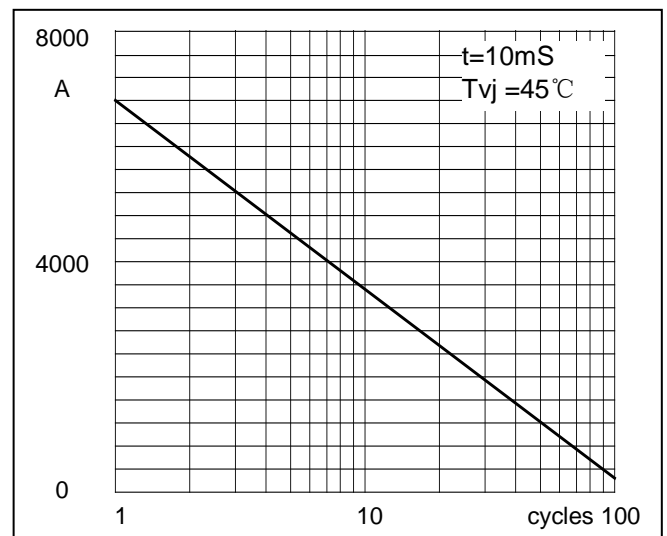

Fig4. Max Non-Repetitive Forward Surge Current

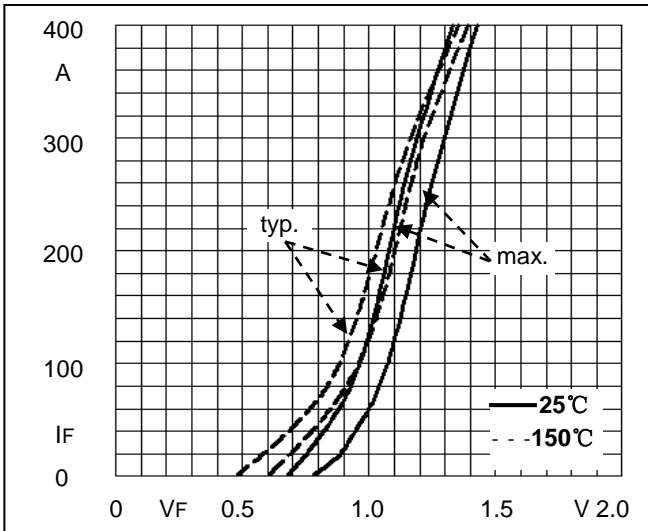
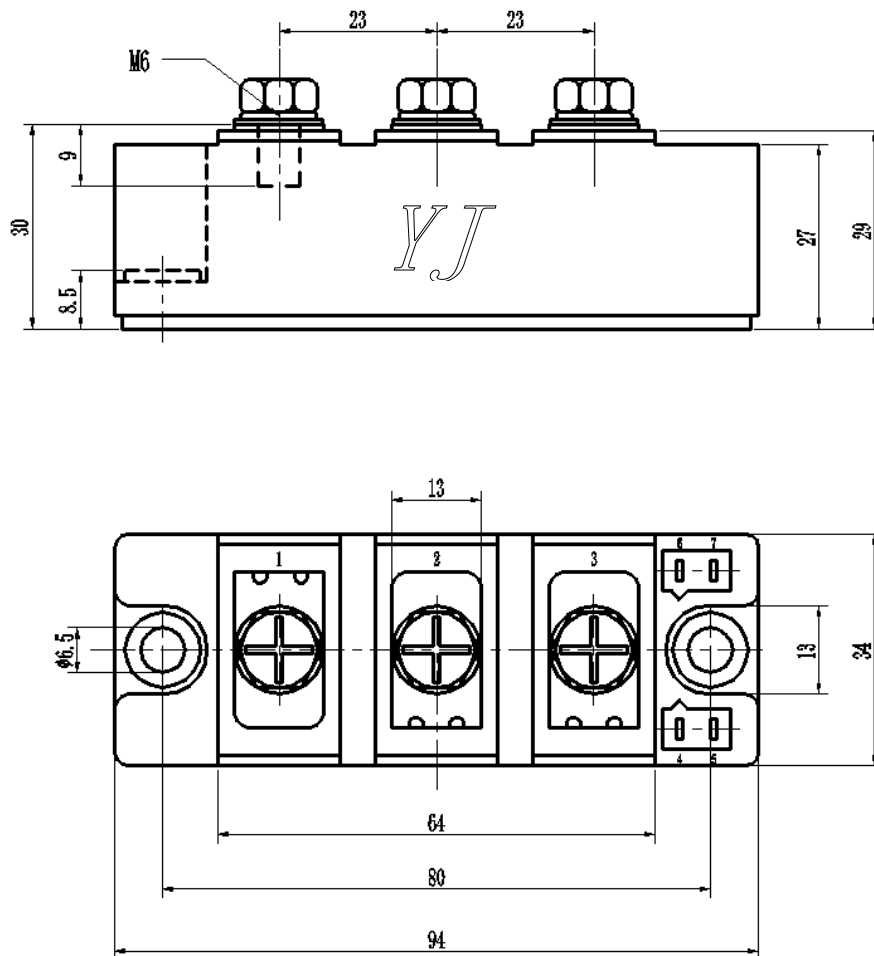

Fig5. Forward Characteristics

## Package Outline Information

CASE: D2



Dimensions in mm