

Aug.1.2022 Copyright 2022 HIROSE ELECTRIC CO., LTD. All Rights Reserved.  
 In case of consideration for using Automotive equipment / device which demand high reliability, kindly contact our sales window correspondents.

ELV. RoHS COMPLIANT

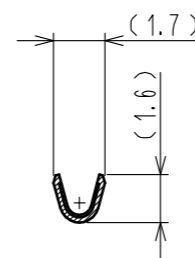

D-D

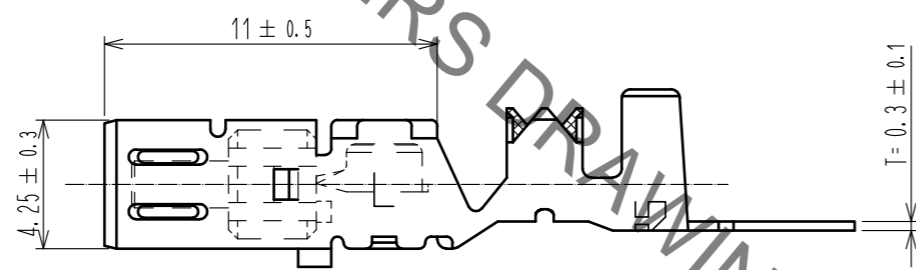
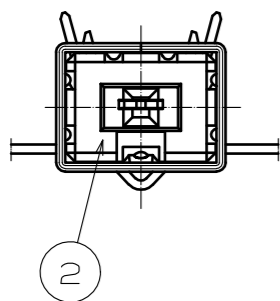
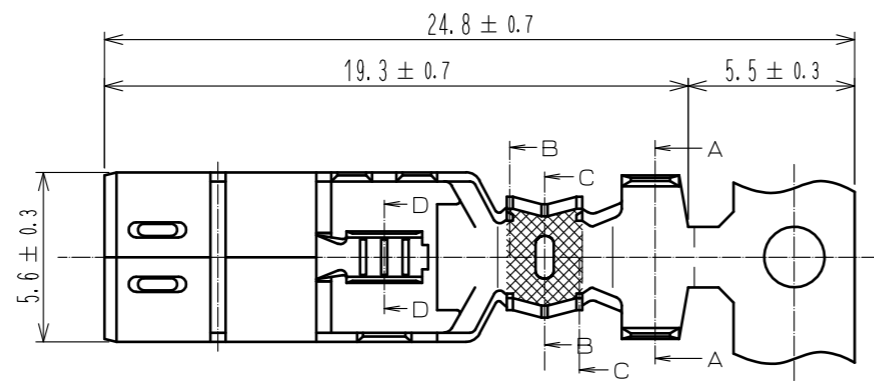
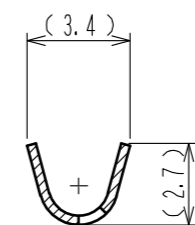

C-C

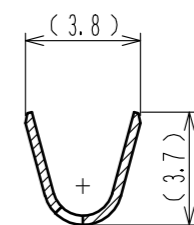

B-B

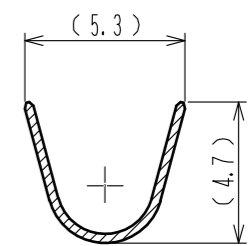

A-A

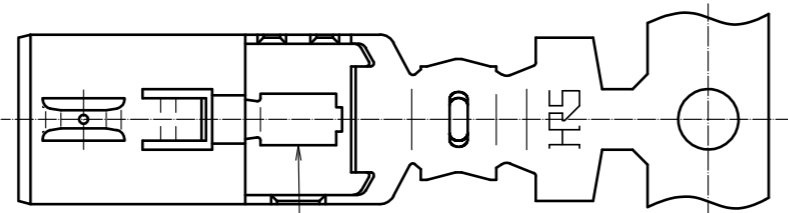

1

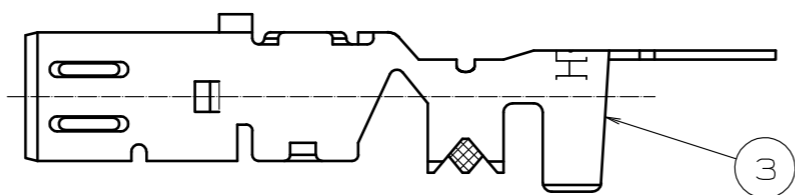

3

NOTE1. PER REEL : 3,000 CONTACTS.

2	PBT	DARK GLAY, UL94HB						
1	COPPER ALLOY	TIN PLATING	3	COPPER ALLOY	TIN PLATING			
NO.	MATERIAL	FINISH . REMARKS	NO.	MATERIAL	FINISH . REMARKS			
UNITS mm			SCALE 4 : 1	COUNT 	DESCRIPTION OF REVISIONS	DESIGNED	CHECKED	DATE
<b>HRS</b> HIROSE ELECTRIC CO., LTD.		APPROVED : KI. HIROKAWA 20200327	DRAWING NO. EDC-371703-55-00					
		CHECKED : MO. OKADA 20200327	PART NO. GT13L-2428/1.6-2.9SCF(55)					
		DESIGNED : NK. IKUTA 20200327	CODE NO. CL763-0132-0-55					
		DRAWN : YK. MITSUISHI 20200318						