

Micropower DC/DC Converter Flash Memory VPP Generator Adjustable and Fixed 5V, 12V

FEATURES

- Uses Off-the-Shelf Inductors
- Low Cost
- 8-Pin DIP or SO Package
- Fixed 5V or 12V Output or Adjustable Version
- Only Four External Components Required
- 360 μ A Standby Current
- Logic-Controlled Shutdown

APPLICATIONS

- Flash Memory VPP Generators
- 5V to 12V Converters
- 3.3V to 12V Converters
- Disk Drives
- PC Plug-In Cards
- Peripherals
- Battery-Powered Equipment

DESCRIPTION

The LT1109A is a simple step-up DC/DC converter. The 8-pin DIP or SOIC devices require only four external components to construct a complete DC/DC converter. Current drain is just 360 μ A at no load, making the device ideal for cost-sensitive applications where standby current must be kept to a minimum.

The LT1109A-12 can deliver 12V at over 150mA from a 5V supply, enough power to program four flash memory chips simultaneously. The LT1109A-5 can deliver 5V at up to 110mA from a 2V input. The devices feature a shutdown pin that turns off the oscillator when taken low. The gated-oscillator design requires no frequency compensation components. High frequency 120kHz operation permits the use of small surface mount inductors and capacitors.

TYPICAL APPLICATION

All Surface Mount
Flash Memory VPP Generator

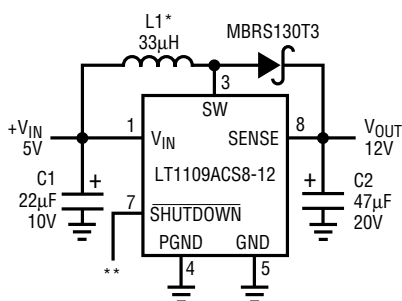

* COILTRONICS CTX33-2
SUMIDA CD54-330LC

** 1 = PROGRAM
0 = SHUTDOWN

1109A TA01

Output Current

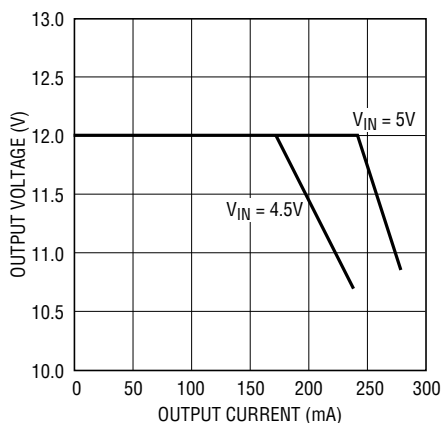

1109A TA02

Output Voltage

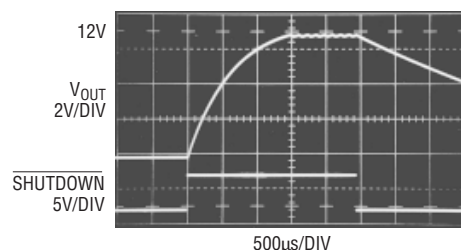

1109A TA03

LT1109A

ABSOLUTE MAXIMUM RATINGS

(Voltages Referred to GND Pin)

Supply Voltage (V_{IN})	-0.4V to 20V
SW Pin Voltage	-0.4V to 50V
Feedback Pin Voltage (LT1109A)	5.5V
Shutdown Pin Voltage	5.5V

Switch Current	2A
Maximum Power Dissipation	300mW
Operating Temperature Range	0°C to 70°C
Storage Temperature Range	-65°C to 150°C
Lead Temperature (Soldering, 10 sec)	300°C

PACKAGE/ORDER INFORMATION

TOP VIEW	ORDER PART NUMBER	TOP VIEW	ORDER PART NUMBER	S8 PART MARKING
<p>N8 PACKAGE 8-LEAD PLASTIC DIP *FIXED VERSIONS $T_{JMAX} = 90^{\circ}\text{C}$, $\theta_{JA} = 130^{\circ}\text{C/W}$</p>	LT1109ACN8 LT1109ACN8-5 LT1109ACN8-12	<p>S8 PACKAGE 8-LEAD PLASTIC SO *FIXED VERSIONS $T_{JMAX} = 90^{\circ}\text{C}$, $\theta_{JA} = 150^{\circ}\text{C/W}$</p>	LT1109ACS8 LT1109ACS8-5 LT1109ACS8-12	1109A 1109A5 1109A1

ELECTRICAL CHARACTERISTICS $T_A = 25^{\circ}\text{C}$, $V_{IN} = 3\text{V}$, unless otherwise noted.

SYMBOL	PARAMETER	CONDITIONS	MIN	TYP	MAX	UNITS	
I_Q	Quiescent Current	Switch Off	●	360	500	μA	
V_{IN}	Input Voltage		●	2	9	V	
	Comparator Trip Point Voltage	LT1109A	●	1.20	1.25	1.30	V
V_{OUT}	Output Sense Voltage	LT1109A-5; $2\text{V} \leq V_{IN} \leq 5\text{V}$ LT1109A-12; $2\text{V} \leq V_{IN} \leq 12\text{V}$	●	4.75	5.00	5.25	V
	Comparator Hysteresis	LT1109A	●	8	12.5	mV	
	Output Voltage Ripple	LT1109A-5 LT1109A-12	●	25	50	mV	
			●	60	120	mV	
f_{OSC}	Oscillator Frequency		●	105	120	135	kHz
			●	95	155	kHz	
t_{ON}	Switch On Time		●	4.1	5.5	6.9	μs
			●	3.8	7.4	μs	
DC	Duty Cycle	Full Load	●	60	68	77	%
V_{CESAT}	Switch Saturation Voltage	$V_{IN} = 3\text{V}$, $I_{SW} = 650\text{mA}$ $V_{IN} = 5\text{V}$, $I_{SW} = 1\text{A}$	●	0.5	0.65	V	
	Switch Leakage Current	$V_{SW} = 12\text{V}$		1	10	μA	
V_{IH}	$\overline{\text{SHUTDOWN}}$ Pin High		●	2.0		V	
V_{IL}	$\overline{\text{SHUTDOWN}}$ Pin Low		●		0.8	V	
I_{IH}	$\overline{\text{SHUTDOWN}}$ Pin Input Current	$V_{\overline{\text{SHUTDOWN}}} \geq 2.0\text{V}$	●		10	μA	
I_L	$\overline{\text{SHUTDOWN}}$ Pin Input Current	$0\text{V} \leq V_{\overline{\text{SHUTDOWN}}} \leq 0.8\text{V}$	●		20	μA	

The ● denotes specifications which apply over the full operating temperature range.

TYPICAL PERFORMANCE CHARACTERISTICS

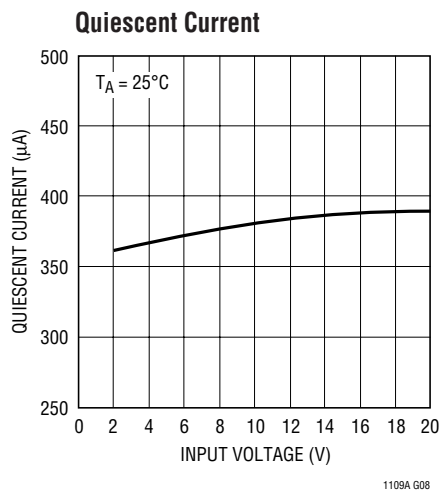
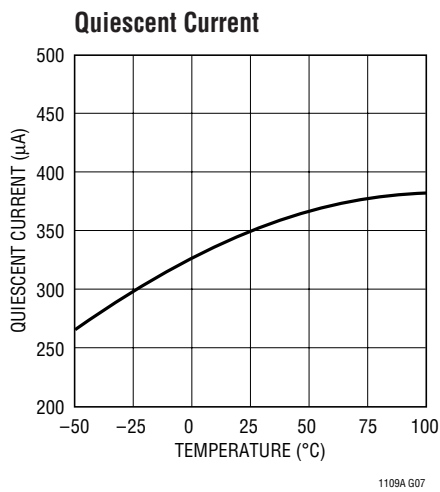
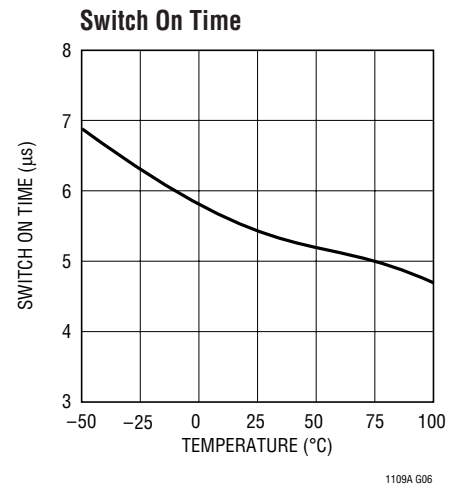
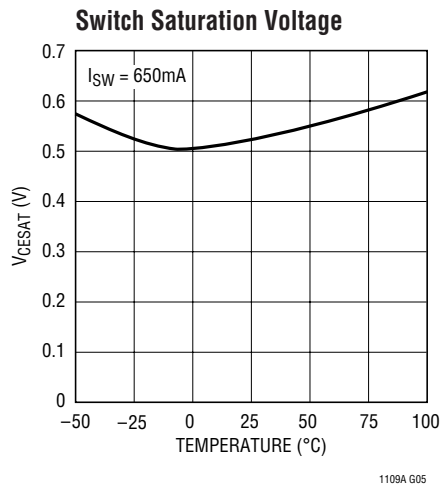
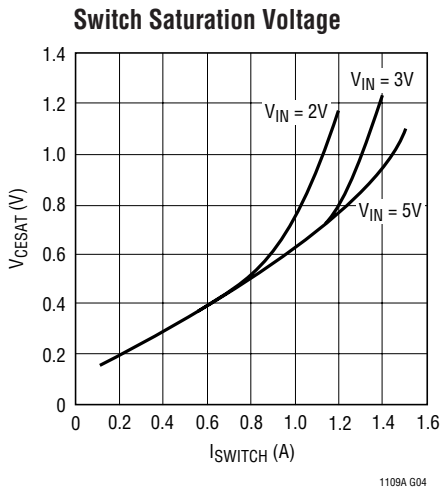
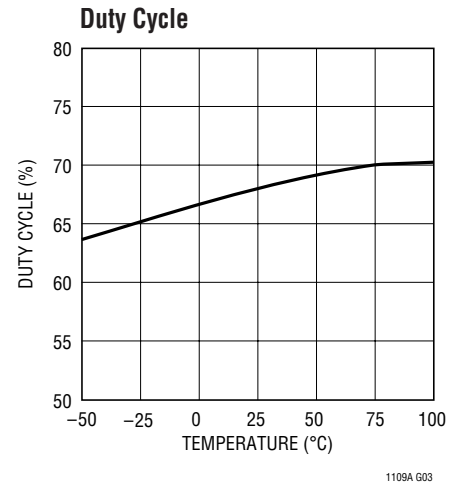
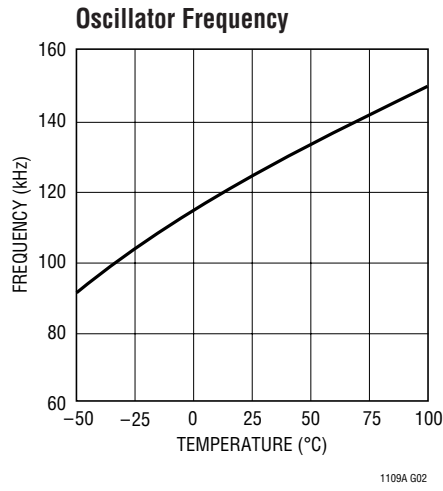
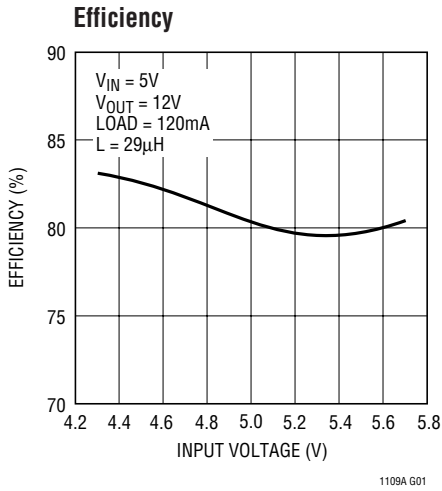

TYPICAL PERFORMANCE CHARACTERISTICS

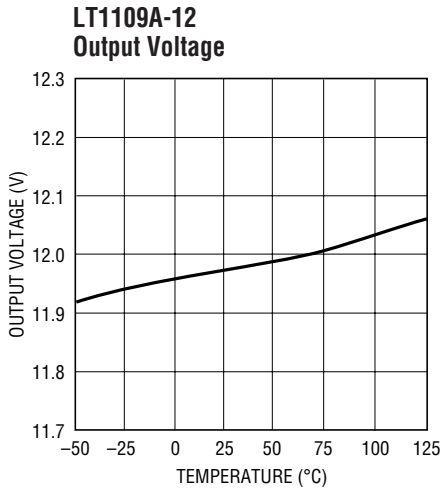

1109A G09

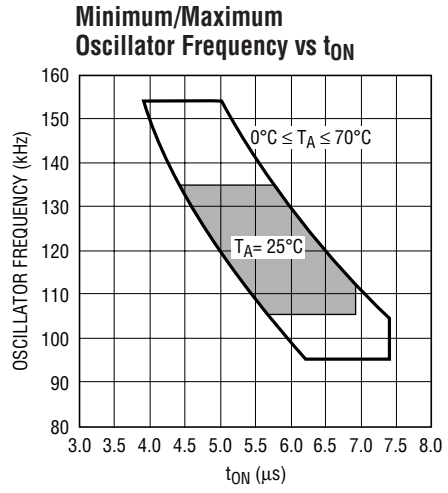

1109A G10

BLOCK DIAGRAMS

LT1109A-5, LT1109A-12

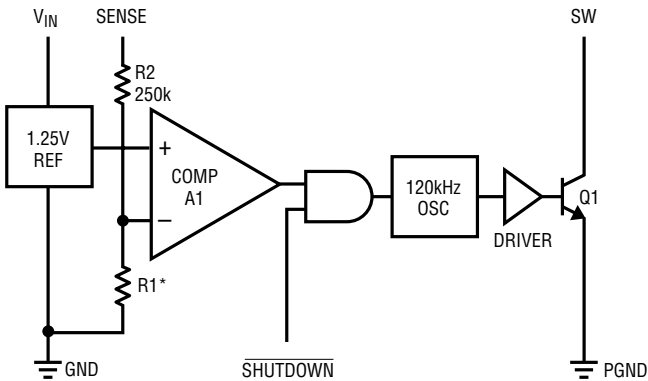

*LT1109A-5: R1 = 83k
 LT1109A-12: R1 = 29k

LT1109A (Adjustable)

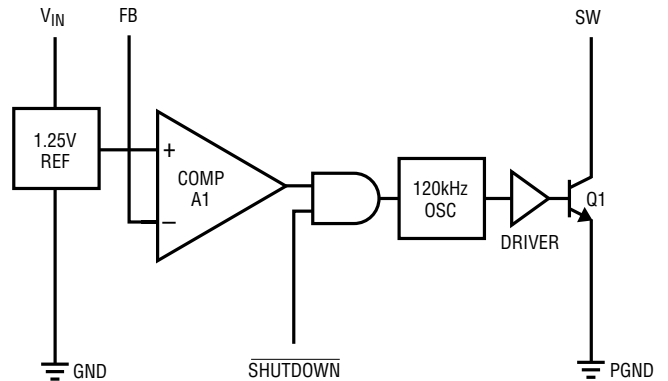

1109A BD

OPERATION

The LT1109A is a micropower step-up DC/DC converter. It uses Burst Mode™ operation to achieve micropower operation yet still deliver more than 2W of output power from a 5V supply. Circuit operation can be best understood by referring to the LT1109A block diagram. With **SHUTDOWN** high, comparator A1 compares the feedback (FB) pin voltage with the 1.25V reference signal. When FB

drops below 1.25V, A1 switches on the 120kHz oscillator. The driver amplifier boosts the signal level to drive the output NPN power switch. When the FB voltage is sufficient to trip A1, the oscillator is turned off. A low signal on the **shutdown pin** gates off the oscillator, overriding A1. With **SHUTDOWN** low, quiescent current remains at 360µA.

Burst Mode™ is a trademark of Linear Technology Corporation

APPLICATIONS INFORMATION

Inductor Selection

A DC/DC converter operates by storing energy as magnetic flux in an inductor core, and then switching this energy into the load. To operate as an efficient energy transfer element, the inductor must fulfill three requirements: inductance value, saturation current and DC resistance. A fourth requirement is physical size. The inductors recommended with the LT1109A circuits are small, surface-mountable and are designed for switch-mode applications. Avoid using RF chokes or air core units since they have very low peak current ratings. The LT1109A works best in situations where the input voltage does not vary much since the device has no internal switch current limit function. For situations where the input voltage varies, such as battery inputs, the LT1107 or LT1111 is suggested instead.

Capacitor Selection

The output capacitor should be chosen on the basis of its equivalent series resistance (ESR) and capacitance value. Low ESR tantalum surface-mountable capacitors such as those made by AVX are well-suited for DC/DC converter applications. Inexpensive aluminum electrolytics may have excessive ESR, resulting in high output ripple. These should be avoided.

Diode Selection

Speed, forward drop, and leakage current are the three main considerations in selecting a diode for LT1109A converters. General purpose rectifiers such as the 1N4001

are *unsuitable* for use in *any* switching regulator application. Although they are rated at 1A, the switching time of a 1N4001 is in the 10µs to 50µs range. At best, efficiency will be severely compromised if this diode is used; at worst, the circuit may not work at all. The 1N5818 is an ideal choice for LT1109A circuits. Surface-mountable versions, such as the MBR130T3, are available as well.

Table 1. Inductor Manufacturers

MANUFACTURER	PART NUMBERS
Coiltronics International 984 S.W. 13th Court Pompano Beach, FL 33069 305-781-8900	Surface Mount OCTA-PAC™ Series
Sumida Electric Co., Ltd. 637 E. Golf Road, Suite 209 Arlington Heights, IL 60005 708-956-0666	CD54 CD105 Surface Mount

OCTA-PAC™ is a trademark of Coiltronics International

Table 2. Capacitor Manufacturers

MANUFACTURER	PART NUMBERS
AVX Myrtle Beach, SC 29578 803-946-0690	TPS Series
Philips Components 2001 W. Blue Heron Blvd. P.O. Box 10330 Riviera Beach, FL 33404 407-881-3200	49MC Series
Sanyo Video Components 1201 Sanyo Avenue San Diego, CA 92073 619-661-6322	OS-CON Series

TYPICAL APPLICATIONS

3.3V Powered Flash Memory VPP Generator

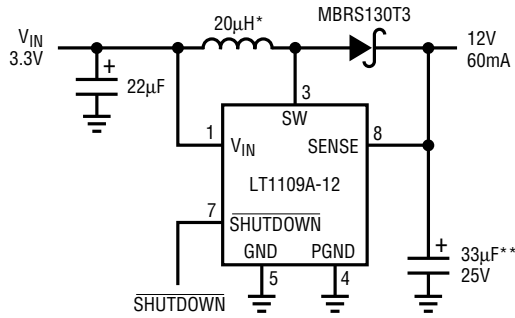

* COILTRONICS CTX20-1
SUMIDA CD54-220LC

** AVX TPS SERIES

1109A TA04

2V Powered Flash Memory VPP Generator

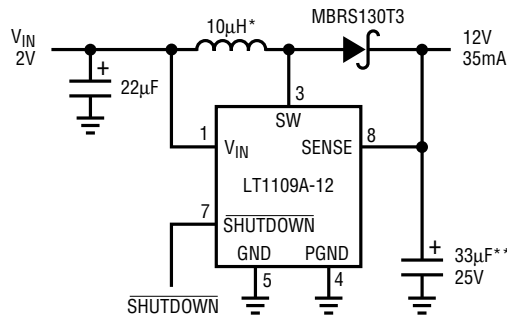

* COILTRONICS CTX10-1
SUMIDA CD54-100LC

** AVX TPS SERIES

1109A TA05

TYPICAL APPLICATIONS

2V to 5V Converter

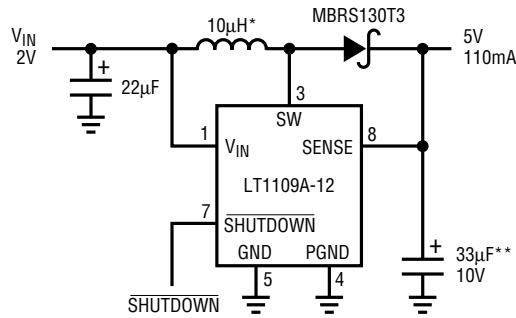

* COILTRONICS CTX10-1
SUMIDA CD54-100LC

** AVX TPS SERIES

1109A TA06

5V to 12V Converter with Shutdown to 0V at Output

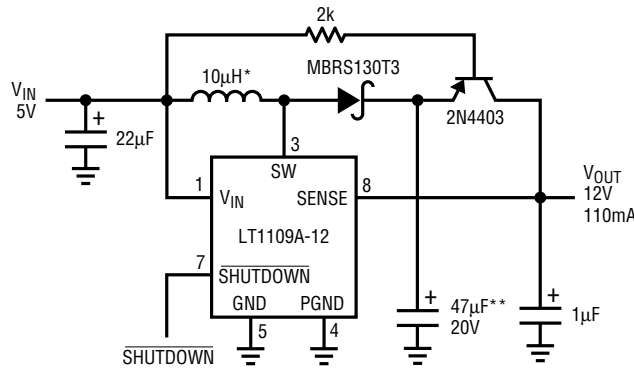

* COILTRONICS CTX33-2
SUMIDA CD54-330LC

** AVX TPS SERIES

1109A TA07

PACKAGE DESCRIPTION Dimensions are in inches (millimeters) unless otherwise noted.

**N8 Package
8-Lead Plastic DIP**

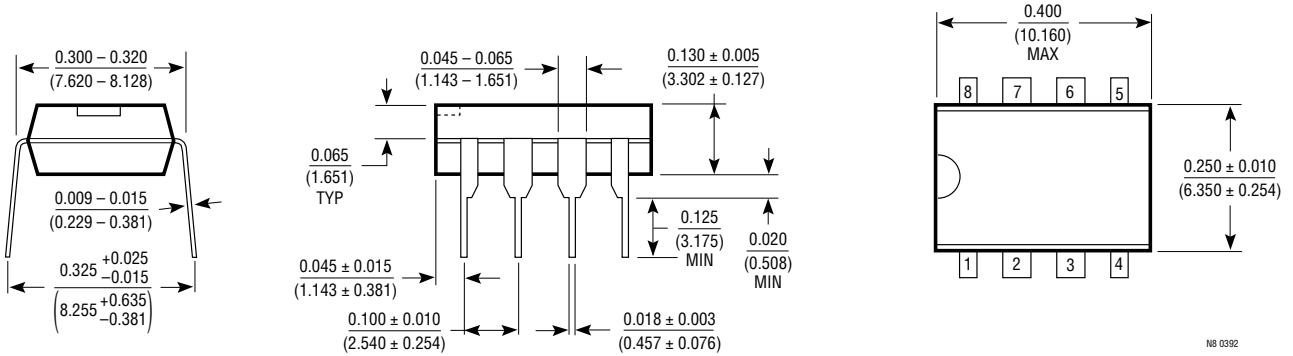

**S8 Package
8-Lead Plastic SOIC**

