

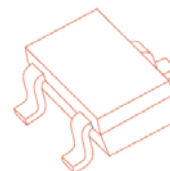

## SOT-323 Plastic-Encapsulate Transistors

**MMST2222A** TRANSISTOR ( NPN )

SOT-323



- 1. BASE
- 2. EMITTER
- 3. COLLECTOR

### FEATURES

- Epitaxial planar die construction
- Complementary PNP Type available(MMST2907A)

MARKING: K3P

MAXIMUM RATINGS (T<sub>a</sub>=25°C unless otherwise noted)

Symbol	Parameter	Value	Unit
V <sub>CB0</sub>	Collector-Base Voltage	75	V
V <sub>CEO</sub>	Collector-Emitter Voltage	40	V
V <sub>EBO</sub>	Emitter-Base Voltage	6	V
I <sub>C</sub>	Collector Current -Continuous	600	mA
P <sub>C</sub>	Collector Dissipation	200	mW
T <sub>J</sub>	Junction Temperature	150	°C
T <sub>stg</sub>	Storage Temperature	-55~+150	°C

### ELECTRICAL CHARACTERISTICS (T<sub>a</sub>=25°C unless otherwise specified)

Parameter	Symbol	Test conditions	Min	Typ	Max	Unit
Collector-base breakdown voltage	V <sub>(BR)CBO</sub>	I <sub>C</sub> = 10μA, I <sub>E</sub> =0	75			V
Collector-emitter breakdown voltage	V <sub>(BR)CEO</sub>	I <sub>C</sub> = 10mA, I <sub>B</sub> =0	40			V
Emitter-base breakdown voltage	V <sub>(BR)EBO</sub>	I <sub>E</sub> =10μA, I <sub>C</sub> =0	6			V
Collector cut-off current	I <sub>CBO</sub>	V <sub>CB</sub> =70 V, I <sub>E</sub> =0			100	nA
Collector cut-off current	I <sub>CEO</sub>	V <sub>CE</sub> =35V, I <sub>B</sub> =0			100	nA
Emitter cut-off current	I <sub>EBO</sub>	V <sub>EB</sub> = 3V, I <sub>C</sub> =0			100	nA
DC current gain	h <sub>FE(1)</sub>	V <sub>CE</sub> =10V, I <sub>C</sub> =0.1mA	35			
	h <sub>FE(2)</sub>	V <sub>CE</sub> =10V, I <sub>C</sub> = 1mA	50			
	h <sub>FE(3)</sub>	V <sub>CE</sub> =10V, I <sub>C</sub> = 10mA	75			
	h <sub>FE(4)</sub>	V <sub>CE</sub> =10V, I <sub>C</sub> = 150mA	100		300	
	h <sub>FE(5)</sub>	V <sub>CE</sub> =10V, I <sub>C</sub> = 500mA	40			
	h <sub>FE(6)</sub>	V <sub>CE</sub> =1V, I <sub>C</sub> = 150mA	35			
Collector-emitter saturation voltage	V <sub>CE(sat)</sub>	I <sub>C</sub> =500 mA, I <sub>B</sub> = 50mA I <sub>C</sub> =150 mA, I <sub>B</sub> =15mA			1 0.3	V
Base-emitter saturation voltage	V <sub>BE(sat)</sub>	I <sub>C</sub> =500 mA, I <sub>B</sub> = 50mA I <sub>C</sub> =150 mA, I <sub>B</sub> =15mA			2.0 1.2	V
Transition frequency	f <sub>T</sub>	V <sub>CE</sub> =20V, I <sub>C</sub> = 20mA f=100MHz	300			MHz
Output Capacitance	C <sub>ob</sub>	V <sub>CB</sub> =10V, I <sub>E</sub> = 0, f=1MHz			8	pF
Delay time	t <sub>d</sub>	V <sub>CC</sub> =30V, V <sub>BE(off)</sub> =-0.5V			10	ns
Rise time	t <sub>r</sub>	I <sub>C</sub> =150mA, I <sub>B1</sub> = 15mA			25	ns
Storage time	t <sub>s</sub>	V <sub>CC</sub> =30V, I <sub>C</sub> =150mA			225	ns
Fall time	t <sub>f</sub>	I <sub>B1</sub> =-I <sub>B2</sub> =15mA			60	ns

# Typical Characteristics

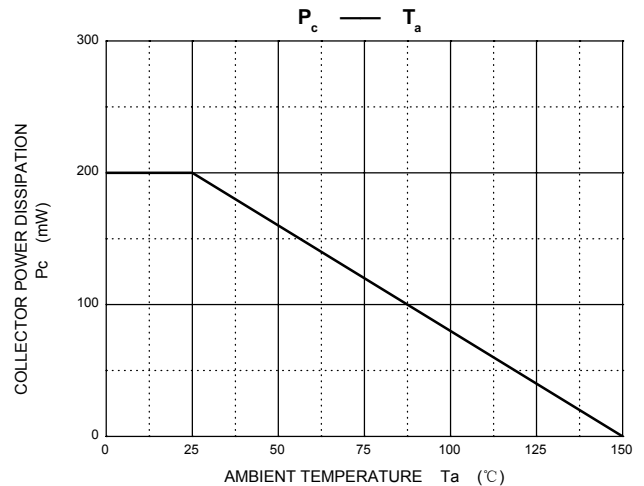
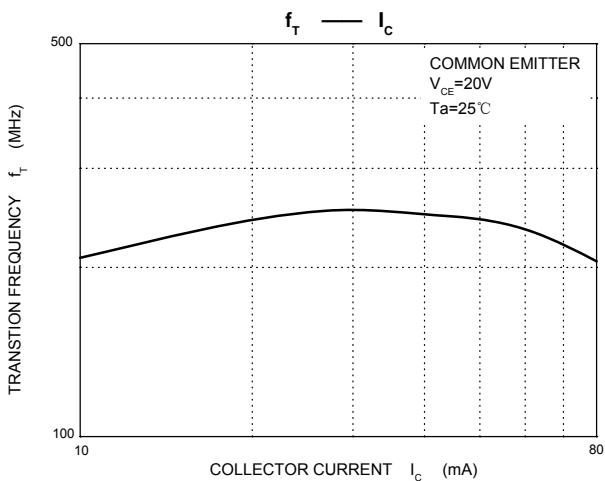
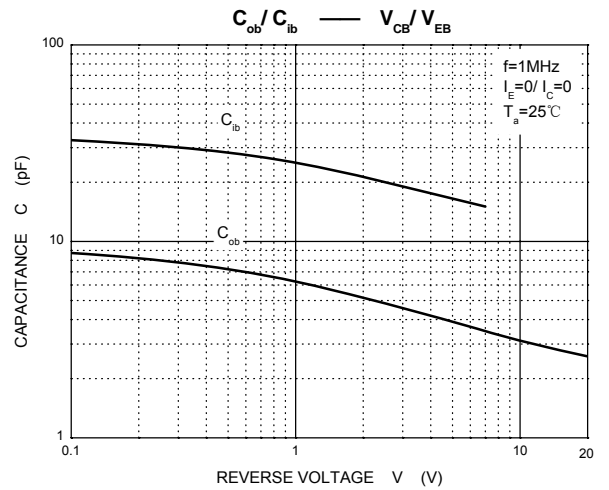
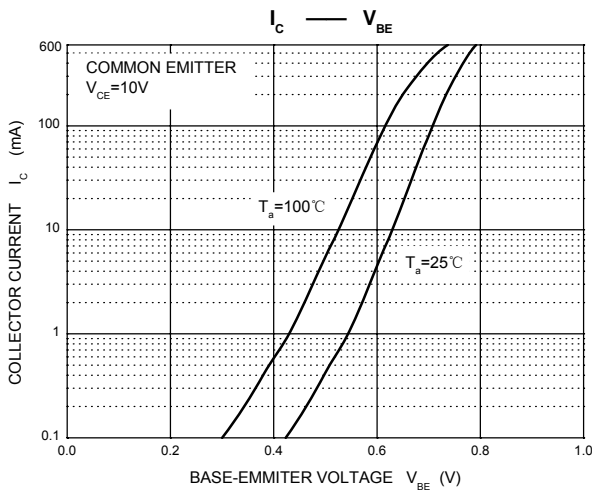
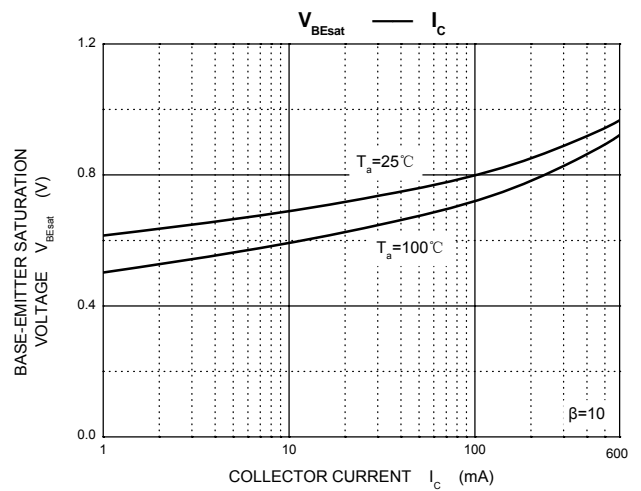
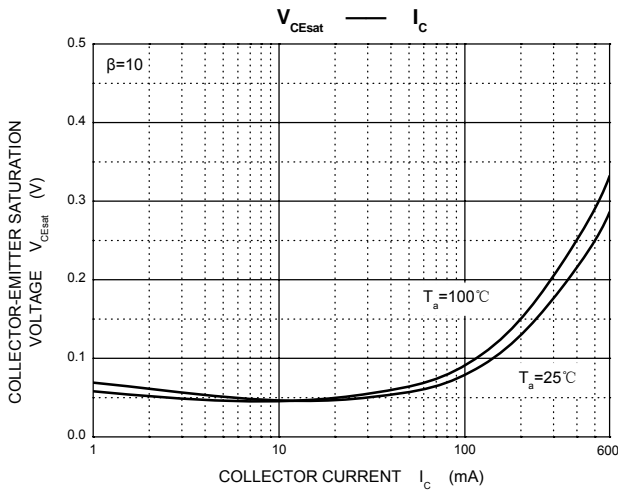
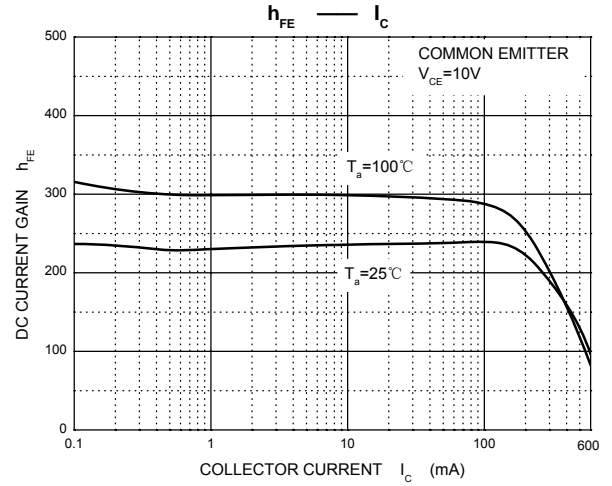
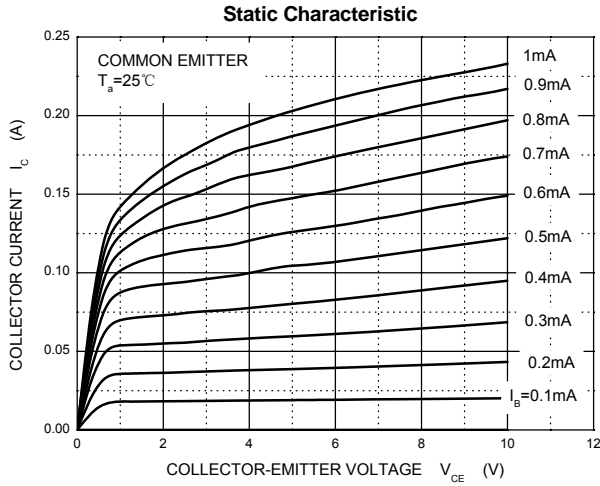

## SOT-323 Package Outline Dimensions



Symbol	Dimensions In Millimeters		Dimensions In Inches	
	Min	Max	Min	Max
A	0.900	1.100	0.035	0.043
A1	0.000	0.100	0.000	0.004
A2	0.900	1.000	0.035	0.039
b	0.200	0.400	0.008	0.016
c	0.080	0.150	0.003	0.006
D	2.000	2.200	0.079	0.087
E	1.150	1.350	0.045	0.053
E1	2.150	2.450	0.085	0.096
e	0.650 TYP		0.026 TYP	
e1	1.200	1.400	0.047	0.055
L	0.525 REF		0.021 REF	
L1	0.260	0.460	0.010	0.018
$\theta$	0°	8°	0°	8°

## SOT-323 Suggested Pad Layout



Note:

1. Controlling dimension: in millimeters.
2. General tolerance:  $\pm 0.05$ mm.
3. The pad layout is for reference purposes only.

### NOTICE

JCET reserve the right to make modifications, enhancements, improvements, corrections or other changes without further notice to any product herein. JCET does not assume any liability arising out of the application or use of any product described herein.

# SOT-323 Tape and Reel

## SOT-323 Embossed Carrier Tape

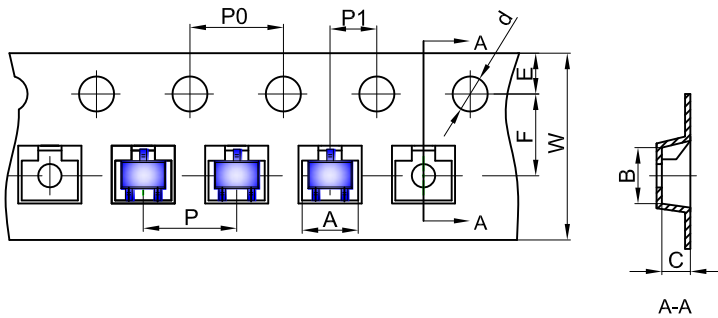

### Packaging Description:

SOT-323 parts are shipped in tape. The carrier tape is made from a dissipative (carbon filled) polycarbonate resin. The cover tape is a multilayer film (Heat Activated Adhesive in nature) primarily composed of polyester film, adhesive layer, sealant, and anti-static sprayed agent. These reeled parts in standard option are shipped with 3,000 units per 7" or 17.8cm diameter reel. The reels are clear in color and is made of polystyrene plastic (anti-static coated).

Dimensions are in millimeter										
Pkg type	A	B	C	d	E	F	P0	P	P1	W
SOT-323	2.25	2.55	1.19	Ø1.55	1.75	3.50	4.00	4.00	2.00	8.00

## SOT-323 Tape Leader and Trailer

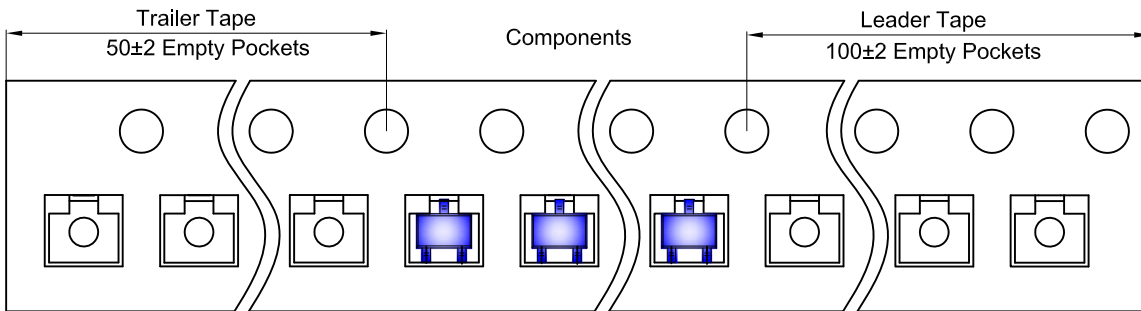

## SOT-323 Reel

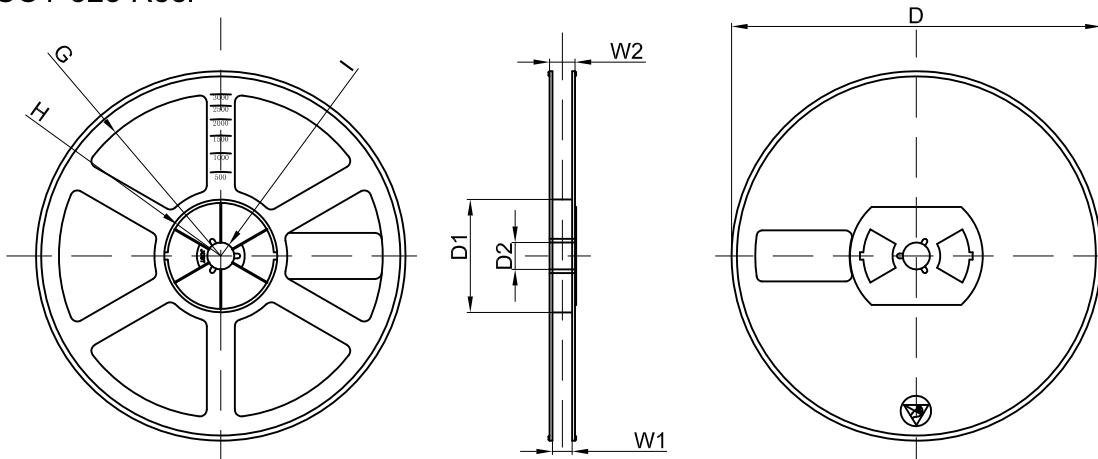

Dimensions are in millimeter								
Reel Option	D	D1	D2	G	H	I	W1	W2
7" Dia	Ø178.00	54.40	13.00	R78.00	R25.60	R6.50	9.50	12.30

REEL	Reel Size	Box	Box Size(mm)	Carton	Carton Size(mm)	G.W.(kg)
3000 pcs	7 inch	45,000 pcs	203×203×195	180,000 pcs	438×438×220	