

Description

The AP3407/A is a 1.4MHz fixed frequency, current mode, PWM synchronous buck (step-down) DC-DC converter, capable of driving a 1.2A load with high efficiency, excellent line and load regulation. The device integrates synchronous P-channel and N-channel power MOSFET switches with low on-resistance. It is ideal for powering portable equipment that runs from a single Li-ion battery.

A standard series of inductors are available from several different manufacturers optimized for use with the AP3407/A. This feature greatly simplifies the design of switch-mode power supplies.

The AP3407/A is available in SOT-23-5.

Features

- Input Voltage Range: 2.5V to 5.5V
- Output Voltage: 0.6V to V_{IN}
- ADJ Output
- Fixed 1.4MHz Frequency
- High Efficiency up to 95%
- Output Current: 1.2A
- Current Mode Control
- 100% Duty Cycle in Dropout
- Built-in Over Current Protection
- Built-in Short Circuit Protection
- Built-in Thermal Shutdown Protection
- Built-in UVLO Function
- Built-in Soft-start
- **Totally Lead-Free & Fully RoHS Compliant (Notes 1 & 2)**
- **Halogen and Antimony Free. "Green" Device (Note 3)**

- Notes:
1. No purposely added lead. Fully EU Directive 2002/95/EC (RoHS) & 2011/65/EU (RoHS 2) compliant.
 2. See http://www.diodes.com/quality/lead_free.html for more information about Diodes Incorporated's definitions of Halogen- and Antimony-free, "Green" and Lead-free.
 3. Halogen- and Antimony-free "Green" products are defined as those which contain <900ppm bromine, <900ppm chlorine (<1500ppm total Br + Cl) and <1000ppm antimony compounds.

Pin Assignments

(Top View)

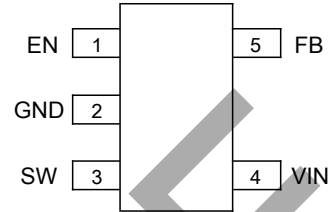

SOT-23-5 for AP3407

(Top View)

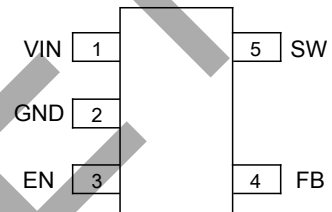

SOT-23-5 for AP3407A

Applications

- Datacom
- Portable Device
- Smart Phone

Typical Applications Circuit

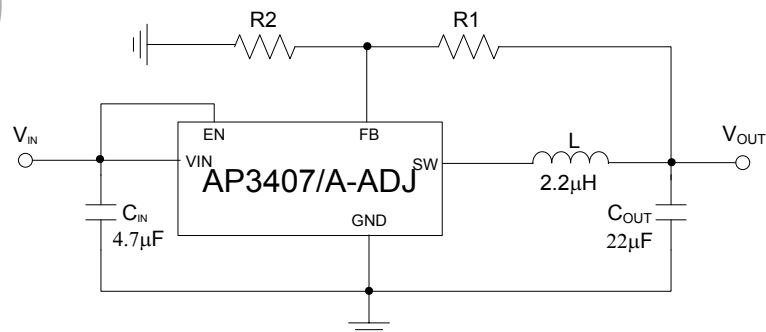

Pin Descriptions

Pin Number		Pin Name	Function
AP3407	AP3407A		
1	3	EN	Control input pin. Forcing this pin above 1.5V enables the IC. Forcing this pin below 0.4V shuts down the IC. When the IC is in shutdown mode, all functions are disabled to decrease the supply current below 1.2A
2	2	GND	Ground pin
3	5	SW	Power switch output pin. Inductor connection to drain of the internal PFET and NFET switches
4	1	VIN	Supply input pin. Bypass to GND with a 4.7µF or greater ceramic capacitor
5	4	FB	This is the feedback pin of the device. Connect this pin directly to the output if the fixed output voltage version is used. For the adjustable version an external resistor divider is connected to this pin.

Functional Block Diagram

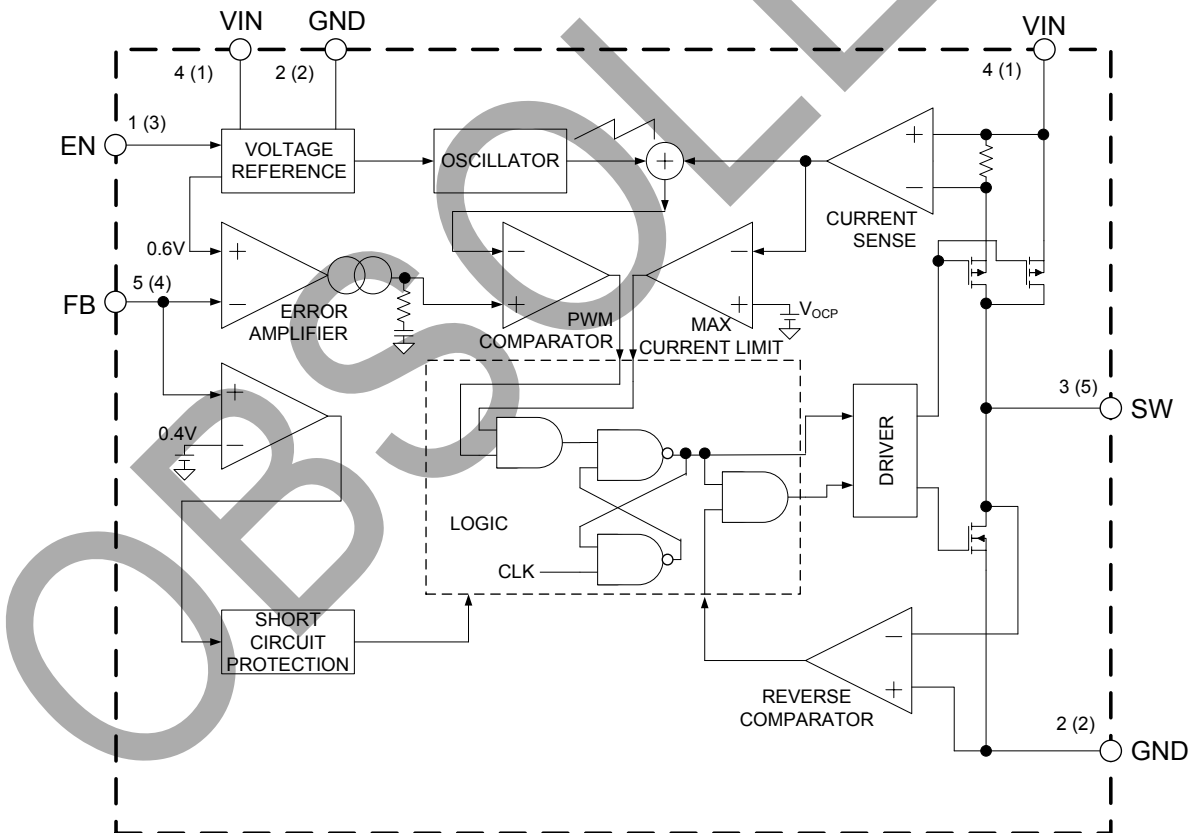

A (B)
A for AP3407
B for AP3407A

OBSOLETE - PART DISCONTINUED

Absolute Maximum Ratings (Note 4)

Symbol	Parameter	Rating	Unit
V _{IN}	Input Voltage	-0.3 to 6.0	V
V _{FB}	Feedback Voltage	-0.3 to V _{IN} +0.3	V
V _{EN}	EN Pin Voltage	-0.3 to V _{IN} +0.3	V
V _{SW}	SW Pin Voltage	-0.3 to V _{IN} +0.3 (Note 6)	V
θ _{JA}	Thermal Resistance (Junction to Ambient)	265	°C/W
θ _{JC}	Thermal Resistance (Junction to Case)	60	°C/W
P _D	Power Dissipation	0.377	W
T _J	Operating Junction Temperature (Note 5)	+150	°C
T _{STG}	Storage Temperature	-65 to +150	°C
T _{LEAD}	Lead Temperature (Soldering, 10sec)	+260	°C

- Notes:
- Stresses greater than those listed under "Absolute Maximum Ratings" may cause permanent damage to the device. These are stress ratings only, and functional operation of the device at these or any other conditions beyond those indicated under "Recommended Operating Conditions" is not implied. Exposure to "Absolute Maximum Ratings" for extended periods may affect device reliability.
 - The junction temperature rise is given by $T_{RISING} = P_D \cdot \theta_{JA}$, where P_D is the power dissipated by regulator, θ_{JA} is the thermal resistance from junction of the die to the ambient temperature; The junction temperature, T_J is given by $T_J = T_A + T_R$, where T_A is the ambient temperature.
 - DC voltage rating, for short period of spike voltage, the minimum voltage rating is -1V, in 20nS.

Recommended Operating Conditions

Symbol	Parameter	Min	Max	Unit
V _{IN}	Input Voltage	2.5	5.5	V
I _{OUT (MAX)}	Maximum Output Current	1.2	–	A
T _A	Operating Ambient Temperature	-40	+85	°C

OBSELETE – PART DISCONTINUED

Electrical Characteristics (@ $V_{IN} = V_{DD} = V_{PVDD} = 3.3V$, $T_A = +25^{\circ}C$, unless otherwise specified.)

Symbol	Parameters	Conditions	Min	Typ	Max	Unit
V_{IN}	Input Voltage	–	2.5	–	5.5	V
I_Q	Quiescent Current	$V_{FB} = 0.65V$	–	62	100	μA
I_{STBY}	Shutdown Supply Current	$V_{EN} = GND$	–	0.1	1	μA
V_{REF}	Reference Voltage	For Adjustable Output Voltage	0.588	0.6	0.612	V
I_{FB}	Feedback Bias Current	$V_{FB} = V_{IN}$	-0.1	–	0.1	μA
ΔV_{OUT}	Output Voltage Accuracy	–	-2	–	2	%
$R_{DS(ON)_P}$	PMOSFET R_{ON}	$I_{SW} = 200mA$	–	0.28	–	Ω
$R_{DS(ON)_N}$	NMOSFET R_{ON}	$I_{SW} = -200mA$	–	0.25	–	Ω
I_{LIM}	Switch Current Limit	$V_{FB} = 0.55V$	1.5	2.0	–	A
V_H	EN Pin Threshold	–	1.5	–	–	V
V_L		–	–	–	0.4	
V_{UVLO}	UVLO Threshold	V_{DD} Rising	–	2.3	–	V
V_{HYS}	UVLO Hysteresis	–	–	0.2	–	
f_{OSC}	Oscillator Frequency	–	1.12	1.40	1.68	MHz
D_{MAX}	Max. Duty Cycle	$V_{FB} = 0V$	100	–	–	%
D_{MIN}	Min. Duty Cycle	$V_{FB} = 6.5V$	–	–	0	
–	N-MOS SW Leakage Current	$V_{IN} = 3.3V$, $V_{SW} = 3.3V$	–	0.1	–	μA
t	Soft-start Time	–	–	1	–	ms
T_{OTSD}	Thermal Shutdown	–	–	+160	–	$^{\circ}C$
T_{HYS}	Thermal Shutdown Hysteresis	–	–	+20	–	$^{\circ}C$

OBSCLETE – PART DISCONTINUED

Performance Characteristics

Efficiency vs. Output Current

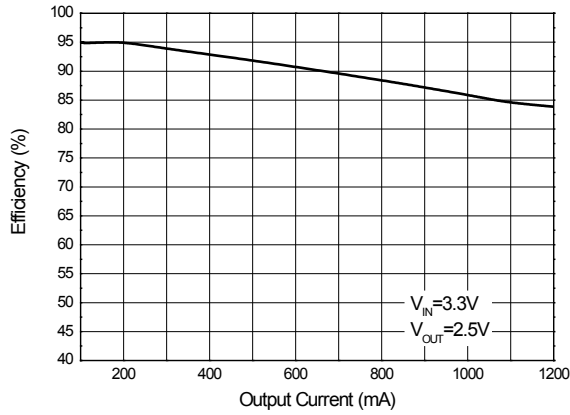

Efficiency vs. Input Voltage

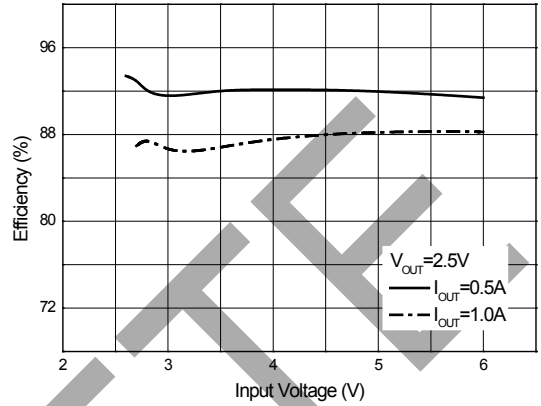

Output Voltage vs. Output Current

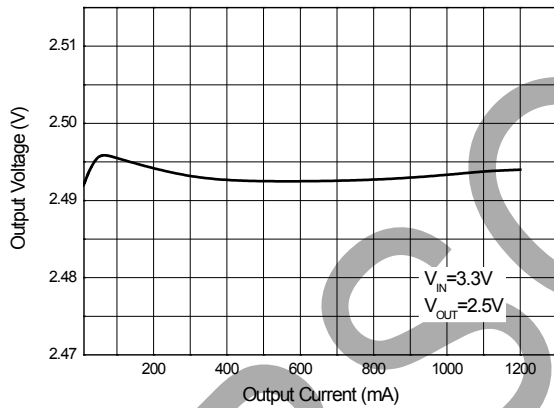

Frequency vs. Input Voltage

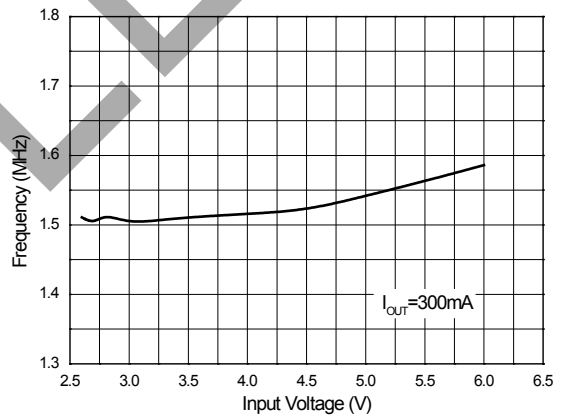

Frequency vs. Temperature

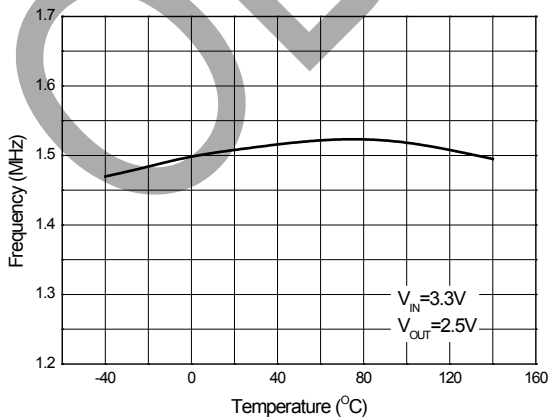

Feedback Voltage vs. Temperature

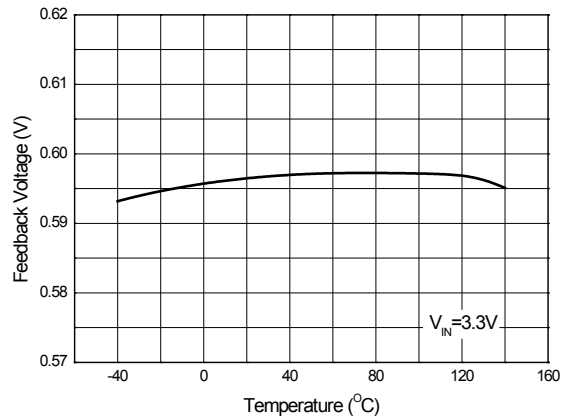

OBSOLETE - PART DISCONTINUED

Performance Characteristics (Cont.)

OCP Current Limit vs. Temperature

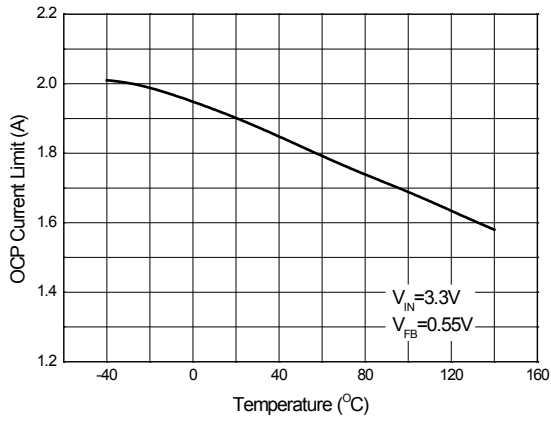

$R_{DS(ON)_{UP}}$ vs. Temperature

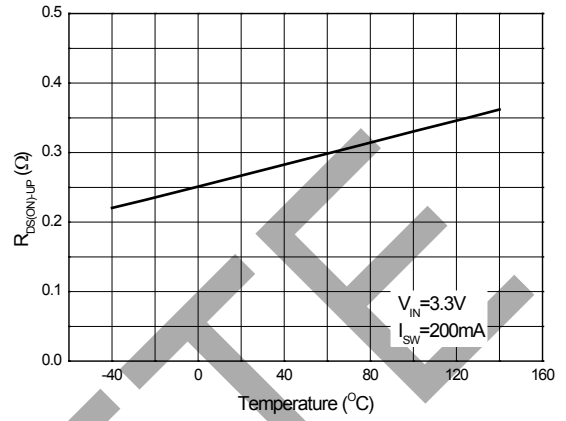

$R_{DS(ON)_{LOW}}$ vs. Temperature

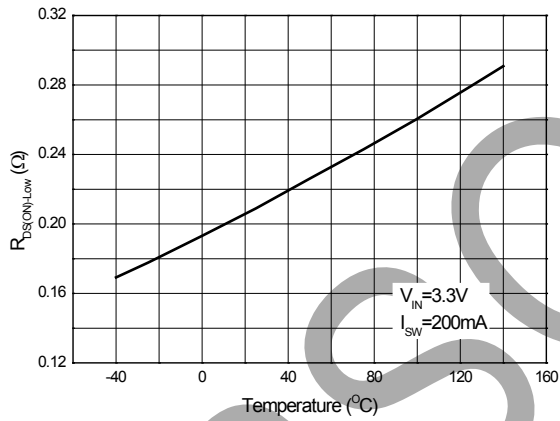

OBSOLETE - PART DISCONTINUED

OBSOLETE

Ordering Information

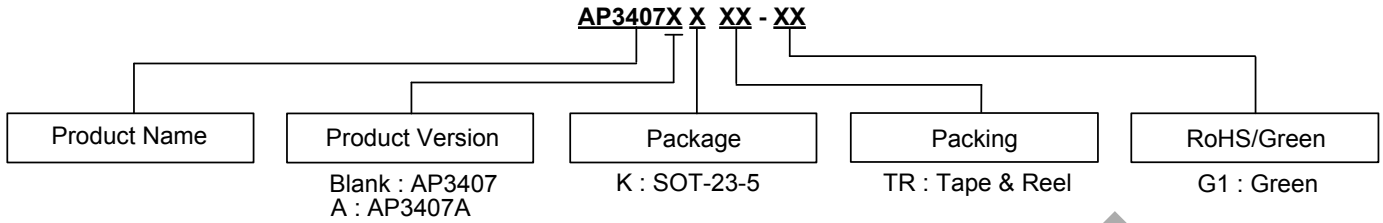

Package	Temperature Range	Part Number	Marking ID	Packing
SOT-23-5	-40 to +85°C	AP3407KTR-G1	GJA	3000/Tape & Reel
		AP3407AKTR-G1	GJB	3000/Tape & Reel

Marking Information

SOT-23-5

(Top View)

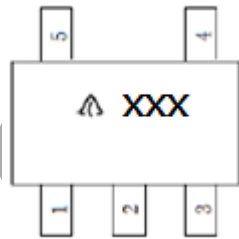

First Line: Logo and Marking ID
(See Ordering Information)

OBSOLETE - PART DISCONTINUED

OBSOLETE

Package Outline Dimensions (All dimensions in mm(inch).)

(1) Package Type: SOT-23-5

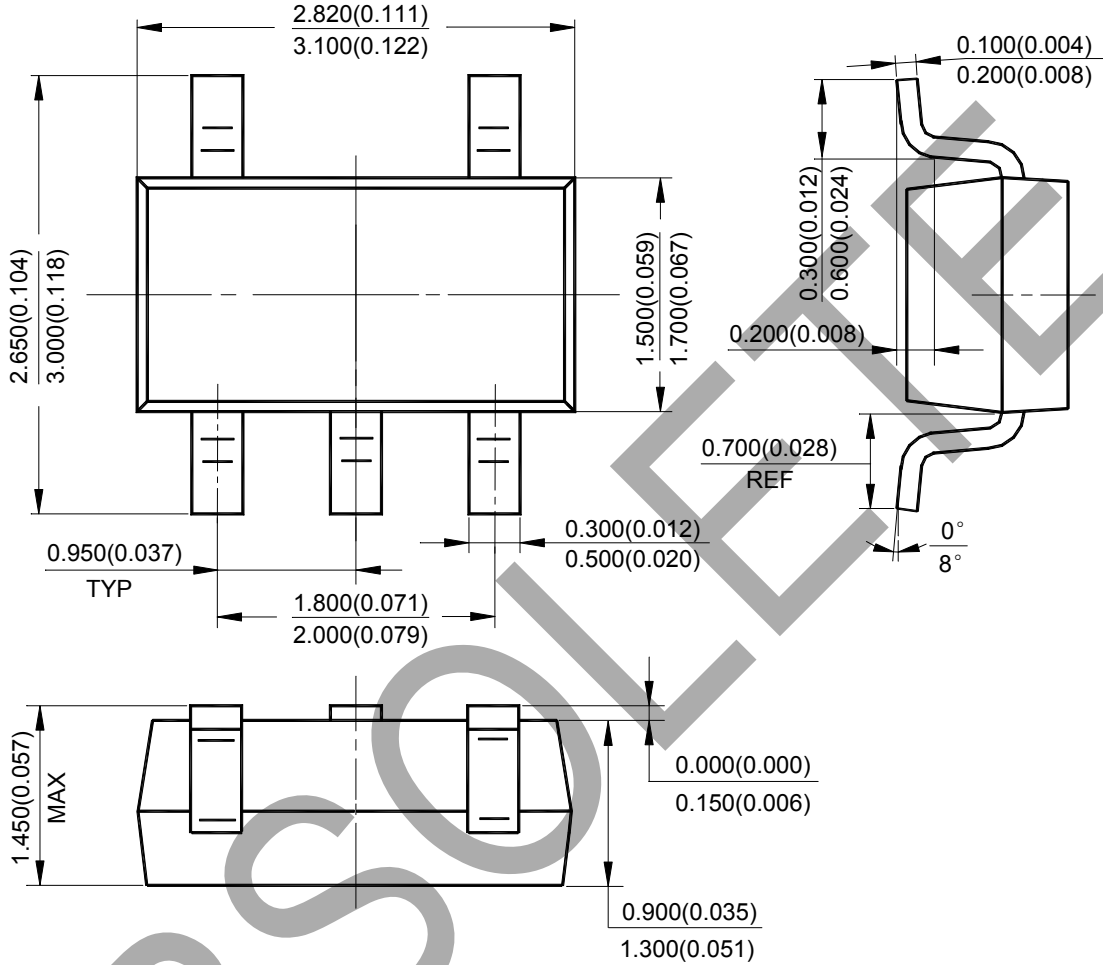

OBSOLETE - PART DISCONTINUED

OBSOLETE

Suggested Pad Layout

(1) Package Type: SOT-23-5

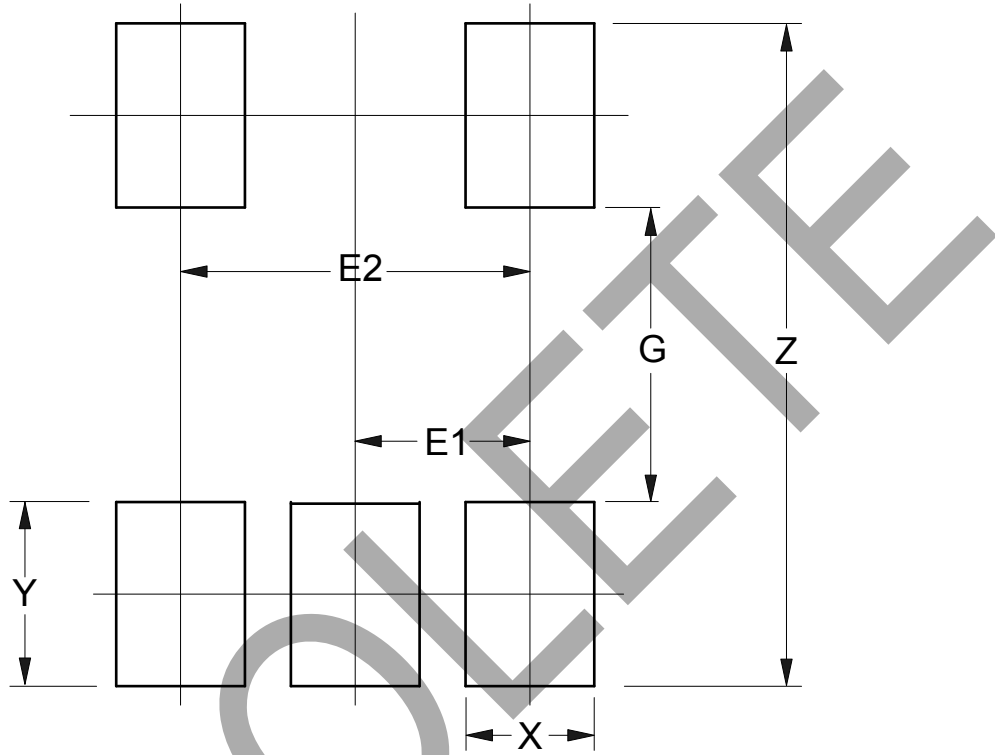

Dimensions	Z (mm)/(inch)	G (mm)/(inch)	X (mm)/(inch)	Y (mm)/(inch)	E1 (mm)/(inch)	E2 (mm)/(inch)
Value	3.600/0.142	1.600/0.063	0.700/0.028	1.000/0.039	0.950/0.037	1.900/0.075

OBSOLETE - PART DISCONTINUED

OBSOLETE

IMPORTANT NOTICE

1. DIODES INCORPORATED AND ITS SUBSIDIARIES ("DIODES") MAKE NO WARRANTY OF ANY KIND, EXPRESS OR IMPLIED, WITH REGARDS TO ANY INFORMATION CONTAINED IN THIS DOCUMENT, INCLUDING, BUT NOT LIMITED TO, THE IMPLIED WARRANTIES OF MERCHANTABILITY, FITNESS FOR A PARTICULAR PURPOSE OR NON-INFRINGEMENT OF THIRD PARTY INTELLECTUAL PROPERTY RIGHTS (AND THEIR EQUIVALENTS UNDER THE LAWS OF ANY JURISDICTION).
2. The Information contained herein is for informational purpose only and is provided only to illustrate the operation of Diodes products described herein and application examples. Diodes does not assume any liability arising out of the application or use of this document or any product described herein. This document is intended for skilled and technically trained engineering customers and users who design with Diodes products. Diodes products may be used to facilitate safety-related applications; however, in all instances customers and users are responsible for (a) selecting the appropriate Diodes products for their applications, (b) evaluating the suitability of the Diodes products for their intended applications, (c) ensuring their applications, which incorporate Diodes products, comply the applicable legal and regulatory requirements as well as safety and functional-safety related standards, and (d) ensuring they design with appropriate safeguards (including testing, validation, quality control techniques, redundancy, malfunction prevention, and appropriate treatment for aging degradation) to minimize the risks associated with their applications.
3. Diodes assumes no liability for any application-related information, support, assistance or feedback that may be provided by Diodes from time to time. Any customer or user of this document or products described herein will assume all risks and liabilities associated with such use, and will hold Diodes and all companies whose products are represented herein or on Diodes' websites, harmless against all damages and liabilities.
4. Products described herein may be covered by one or more United States, international or foreign patents and pending patent applications. Product names and markings noted herein may also be covered by one or more United States, international or foreign trademarks and trademark applications. Diodes does not convey any license under any of its intellectual property rights or the rights of any third parties (including third parties whose products and services may be described in this document or on Diodes' website) under this document.
5. Diodes products are provided subject to Diodes' Standard Terms and Conditions of Sale (<https://www.diodes.com/about/company/terms-and-conditions/terms-and-conditions-of-sales/>) or other applicable terms. This document does not alter or expand the applicable warranties provided by Diodes. Diodes does not warrant or accept any liability whatsoever in respect of any products purchased through unauthorized sales channel.
6. Diodes products and technology may not be used for or incorporated into any products or systems whose manufacture, use or sale is prohibited under any applicable laws and regulations. Should customers or users use Diodes products in contravention of any applicable laws or regulations, or for any unintended or unauthorized application, customers and users will (a) be solely responsible for any damages, losses or penalties arising in connection therewith or as a result thereof, and (b) indemnify and hold Diodes and its representatives and agents harmless against any and all claims, damages, expenses, and attorney fees arising out of, directly or indirectly, any claim relating to any noncompliance with the applicable laws and regulations, as well as any unintended or unauthorized application.
7. While efforts have been made to ensure the information contained in this document is accurate, complete and current, it may contain technical inaccuracies, omissions and typographical errors. Diodes does not warrant that information contained in this document is error-free and Diodes is under no obligation to update or otherwise correct this information. Notwithstanding the foregoing, Diodes reserves the right to make modifications, enhancements, improvements, corrections or other changes without further notice to this document and any product described herein. This document is written in English but may be translated into multiple languages for reference. Only the English version of this document is the final and determinative format released by Diodes.
8. Any unauthorized copying, modification, distribution, transmission, display or other use of this document (or any portion hereof) is prohibited. Diodes assumes no responsibility for any losses incurred by the customers or users or any third parties arising from any such unauthorized use.

Copyright © 2021 Diodes Incorporated

www.diodes.com

OBSOLETE - PART DISCONTINUED