

750 mA μ Cap Low Voltage, Low Dropout Regulator

Features

- Fixed and Adjustable Output Voltages to 1.24V
- 280 mV Typical Dropout at 750 mA
 - Ideal for 3.0V to 2.5V Conversion
 - Ideal for 2.5V to 1.8V or 1.65V Conversion
- Stable with Ceramic Capacitor
- 750 mA Minimum Guaranteed Output Current
- 1% Initial Accuracy
- Low Ground Current
- Current Limiting and Thermal Shutdown
- Reversed-Leakage Protection
- Fast Transient Response
- Low Profile Power MSOP-8 Package

Applications

- Fiber Optic Modules
- LDO Linear Regulator for PC Add-In Cards
- PowerPC Power Supplies
- High-Efficiency Linear Power Supplies
- SMPS Post Regulator
- Multimedia and PC Processor Supplies
- Battery Chargers
- Low-Voltage Microcontrollers and Digital Logic

General Description

The MIC3775 is a 750 mA low dropout linear voltage regulators that provides low voltage, high current output from an extremely small package. Utilizing Microchip's proprietary Super β PNP pass element, the MIC3775 offers extremely low dropout (typically 280 mV at 750 mA) and low ground current (typically 7.5 mA at 750 mA).

The MIC3775 is ideal for PC add-in cards that need to convert from standard 5V to 3.3V or 3.0V, 3.3V to 2.5V, or 2.5V to 1.8V or 1.65V. A guaranteed maximum dropout voltage of 500 mV over all operating conditions allows the MIC3775 to provide 2.5V from a supply as low as 3.0V and 1.8V or 1.5V from a supply as low as 2.25V.

The MIC3775 is fully protected with overcurrent limiting, thermal shutdown, and reversed-leakage protection. Fixed and adjustable output voltage options are available with an operating temperature range of -40°C to $+125^{\circ}\text{C}$.

Package Types

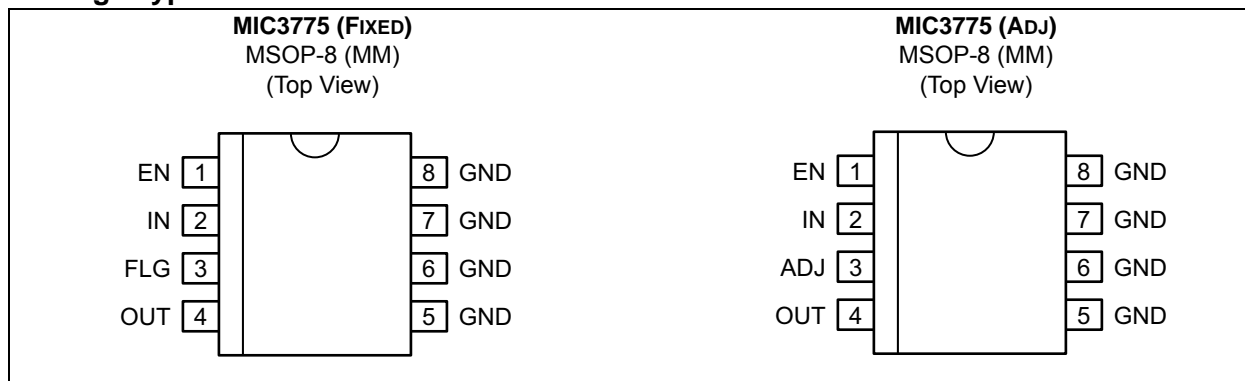

MIC3775

Typical Application Circuit

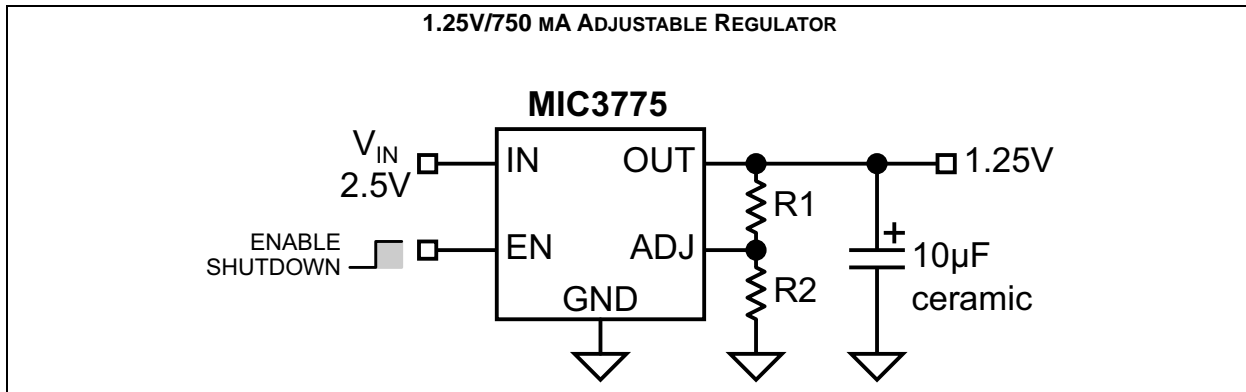

Functional Block Diagrams

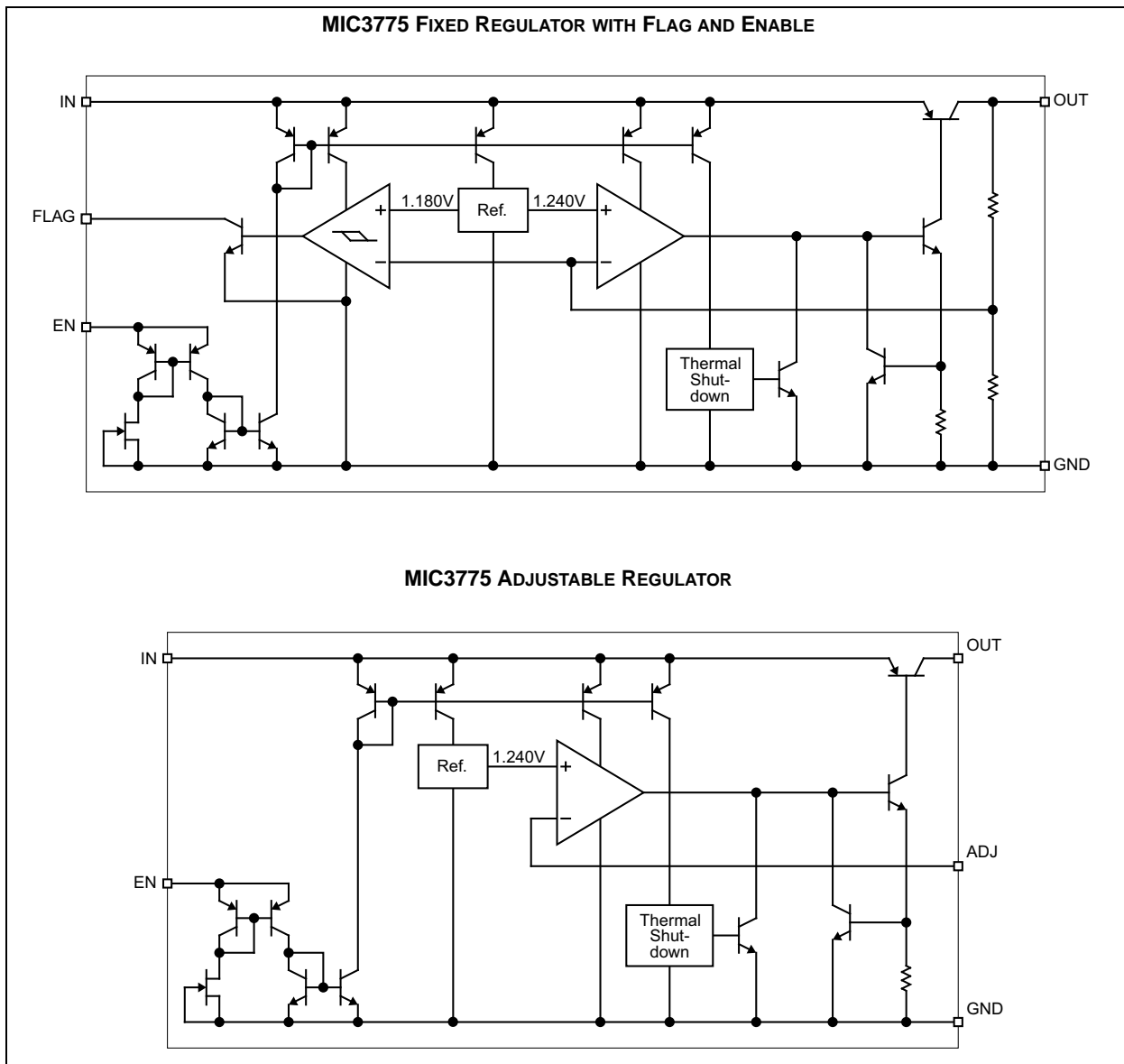

1.0 ELECTRICAL CHARACTERISTICS

Absolute Maximum Ratings †

Supply Voltage (V_{IN})	+6.5V
Enable Voltage (V_{EN})	+6.5V
Lead Temperature (Soldering, 5 sec.)	+260°C
Storage Temperature (T_S)	-65°C to +150°C
ESD Rating	Note 1

Operating Ratings ††

Supply Voltage (V_{IN})	+2.25V to +6V
Enable Voltage (V_{EN})	0V to +6V
Maximum Power Dissipation ($P_{D(MAX)}$)	Note 2
Junction Temperature (T_J)	-40°C to +125°C
Package Thermal Resistance (MSOP-8, θ_{JA})	80°C/W

† **Notice:** Stresses above those listed under “Absolute Maximum Ratings” may cause permanent damage to the device. This is a stress rating only and functional operation of the device at those or any other conditions above those indicated in the operational sections of this specification is not intended. Exposure to maximum rating conditions for extended periods may affect device reliability.

†† **Notice:** The device is not guaranteed to function outside its operating ratings.

Note 1: Devices are ESD sensitive. Handling precautions are recommended. Human body model, 1.5 k Ω in series with 100 pF.

2: $P_{D(MAX)} = (T_{J(MAX)} - T_A) \div \theta_{JA}$, where θ_{JA} depends upon the printed circuit layout. See “Applications Information.”

ELECTRICAL CHARACTERISTICS

Electrical Characteristics: $V_{IN} = V_{OUT} + 1V$; $V_{EN} = 2.25V$; $T_J = +25^\circ C$, **bold** values indicate $-40^\circ C \leq T_J \leq +125^\circ C$, unless noted. Note 1

Parameter	Sym.	Min.	Typ.	Max.	Units	Conditions
Output Voltage	V_{OUT}	-1	—	1	%	10 mA
		-2	—	2		$10 \text{ mA} \leq I_{OUT} \leq 750 \text{ mA}$, $V_{OUT} + 1V \leq V_{IN} \leq 6V$
Line Regulation	$\frac{\Delta V_{OUT}}{V_{OUT}}$	—	0.06	0.5	%	$I_{OUT} = 10 \text{ mA}$, $V_{OUT} + 1V \leq V_{IN} \leq 6V$
Load Regulation	$\frac{\Delta V_{OUT}}{V_{OUT}}$	—	0.2	1	%	$V_{IN} = V_{OUT} + 1V$, $10 \text{ mA} \leq I_{OUT} \leq 750 \text{ mA}$
Output Voltage Temp. Coefficient	$\frac{\Delta V_{OUT}}{\Delta T}$	—	40	—	ppm/°C	Note 2
Dropout Voltage (Note 3)	V_{DO}	—	125	200	mV	$I_{OUT} = 100 \text{ mA}$
		—	—	250		$I_{OUT} = 500 \text{ mA}$
		—	210	—		$I_{OUT} = 750 \text{ mA}$
		—	280	500		

Note 1: Specification for packaged product only.

2: Output voltage temperature coefficient is $\frac{\Delta V_{OUT(WORSTCASE)}}{(T_{J(MAX)} - T_{J(MIN)})}$ where $T_{J(MAX)}$ is +125°C and $T_{J(MIN)}$ is -40°C.

3: $V_{DO} = V_{IN} - V_{OUT}$ when V_{OUT} decreases to 98% of its nominal output voltage with $V_{IN} = V_{OUT} + 1V$. For output voltages below 1.75V, dropout voltage is the input-to-output voltage differential with the minimum input voltage being 2.25V. Minimum input operating voltage is 2.25V.

4: I_{GND} is the quiescent current. $I_{IN} = I_{GND} + I_{OUT}$.

MIC3775

ELECTRICAL CHARACTERISTICS (CONTINUED)

Electrical Characteristics: $V_{IN} = V_{OUT} + 1V$; $V_{EN} = 2.25V$; $T_J = +25^\circ C$, **bold** values indicate $-40^\circ C \leq T_J \leq +125^\circ C$, unless noted. [Note 1](#)

Parameter	Sym.	Min.	Typ.	Max.	Units	Conditions
Ground Current (Note 4)	I_{GND}	—	700	—	μA	$I_{OUT} = 100\text{ mA}$, $V_{IN} = V_{OUT} + 1V$
		—	3.7	—	mA	$I_{OUT} = 500\text{ mA}$, $V_{IN} = V_{OUT} + 1V$
		—	7.5	15		$I_{OUT} = 750\text{ mA}$, $V_{IN} = V_{OUT} + 1V$
Current Limit	$I_{OUT(LIM)}$	—	1.6	2.5	A	$V_{OUT} = 0V$, $V_{IN} = V_{OUT} + 1V$
Enable Input						
Enable Input Voltage	V_{EN}	—	—	0.8	V	Logic low (off)
		2.25	—	—		Logic high (on)
Enable Input Current	I_{EN}	1	10	30	μA	$V_{EN} = 2.25V$
		—	—	2		$V_{EN} = 0.8V$
		—	—	4		
Flag Output						
Output Leakage Current	$I_{FLG(LEAK)}$	—	0.01	1	μA	$V_{OH} = 6V$
		—	—	2		
Output Low Voltage	$V_{FLG(DO)}$	—	250	500	mV	$V_{IN} = 2.250V$, $I_{OL} = 250\ \mu A$
Low Threshold	V_{FLG}	93	—	—	%	% of V_{OUT}
High Threshold		—	—	99.2		% of V_{OUT}
Hysteresis		—	1	—		—
Adjustable Output Only						
Reference Voltage	V_{REF}	1.227	1.240	1.252	V	—
		1.215	—	1.265		
Adjust Pin Bias Current	—	—	40	80	nA	—
		—	—	120		

Note 1: Specification for packaged product only.

- Output voltage temperature coefficient is $\Delta V_{OUT(WORSTCASE)} \div (T_{J(MAX)} - T_{J(MIN)})$ where $T_{J(MAX)}$ is $+125^\circ C$ and $T_{J(MIN)}$ is $-40^\circ C$.
- $V_{DO} = V_{IN} - V_{OUT}$ when V_{OUT} decreases to 98% of its nominal output voltage with $V_{IN} = V_{OUT} + 1V$. For output voltages below 1.75V, dropout voltage is the input-to-output voltage differential with the minimum input voltage being 2.25V. Minimum input operating voltage is 2.25V.
- I_{GND} is the quiescent current. $I_{IN} = I_{GND} + I_{OUT}$.

TEMPERATURE SPECIFICATIONS

Parameters	Sym.	Min.	Typ.	Max.	Units	Conditions
Temperature Ranges						
Maximum Junction Temperature Range	T_J	-40	—	+125	°C	—
Storage Temperature Range	T_S	-65	—	+150	°C	—
Lead Temperature	—	—	—	+260	°C	Soldering, 5 sec.
Package Thermal Resistances						
Thermal Resistance, MSOP 8-Ld	θ_{JA}	—	80	—	°C/W	—

Note 1: The maximum allowable power dissipation is a function of ambient temperature, the maximum allowable junction temperature and the thermal resistance from junction to air (i.e., T_A , T_J , θ_{JA}). Exceeding the maximum allowable power dissipation will cause the device operating junction temperature to exceed the maximum +125°C rating. Sustained junction temperatures above +125°C can impact the device reliability.

2.0 TYPICAL PERFORMANCE CURVES

Note: The graphs and tables provided following this note are a statistical summary based on a limited number of samples and are provided for informational purposes only. The performance characteristics listed herein are not tested or guaranteed. In some graphs or tables, the data presented may be outside the specified operating range (e.g., outside specified power supply range) and therefore outside the warranted range.

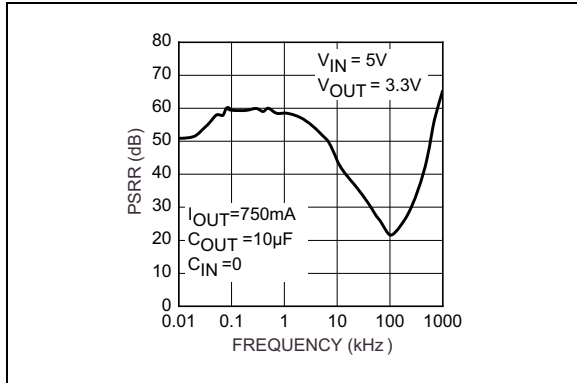

FIGURE 2-1: Power Supply Rejection Ratio.

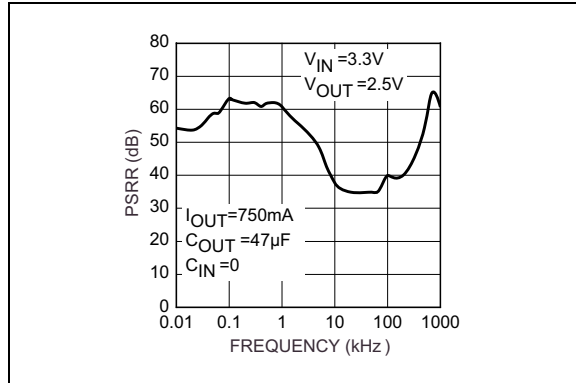

FIGURE 2-4: Power Supply Rejection Ratio.

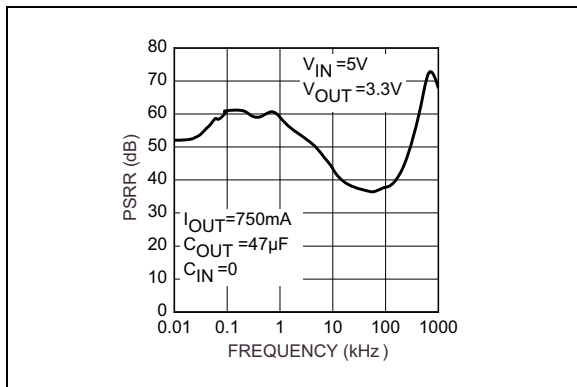

FIGURE 2-2: Power Supply Rejection Ratio.

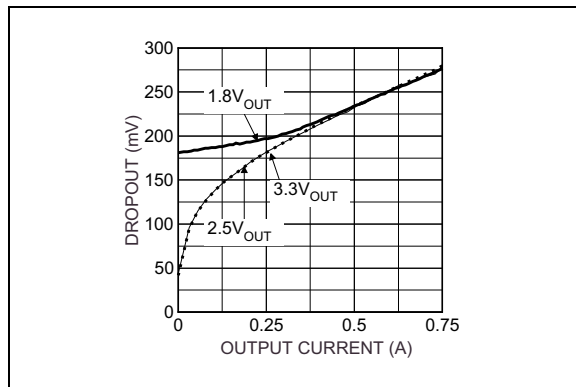

FIGURE 2-5: Dropout vs. Output Current.

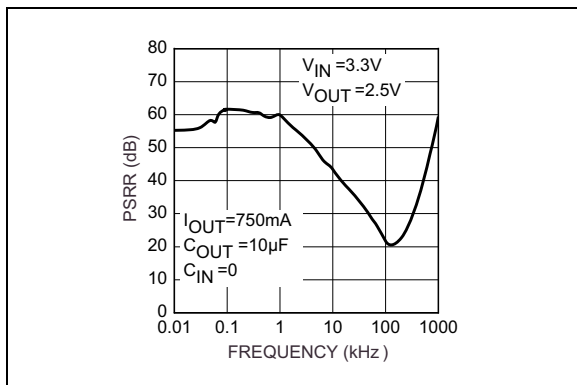

FIGURE 2-3: Power Supply Rejection Ratio.

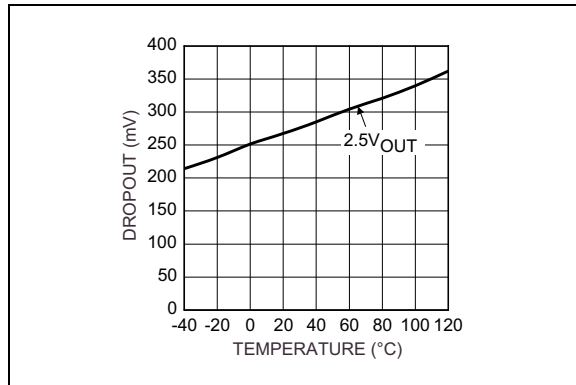

FIGURE 2-6: Dropout vs. Temperature.

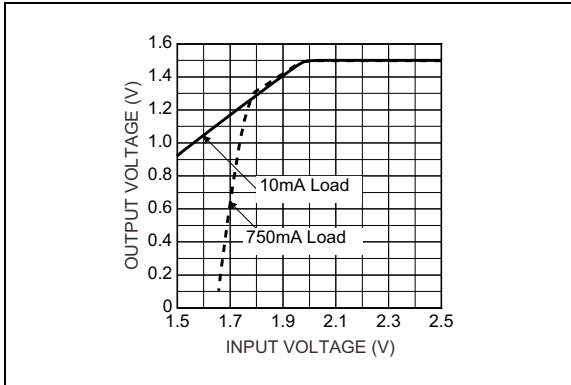

FIGURE 2-7: Dropout Characteristics (1.5V).

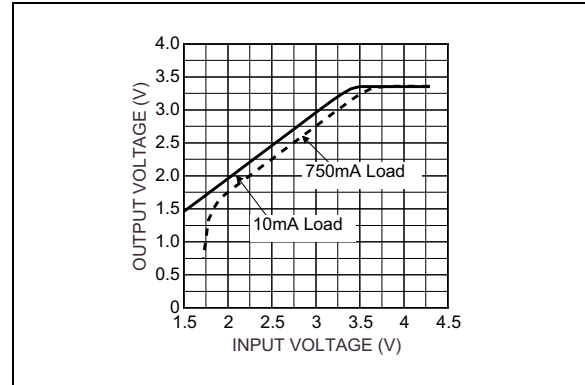

FIGURE 2-10: Dropout Characteristics (3.3V).

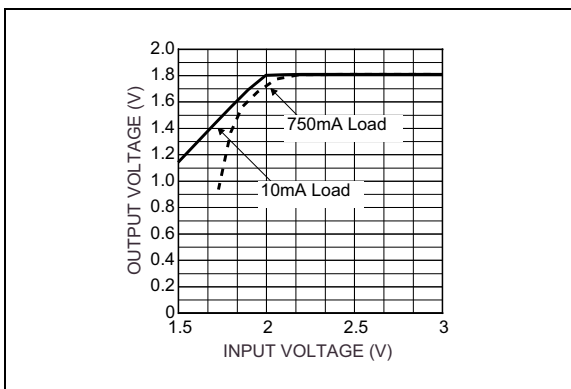

FIGURE 2-8: Dropout Characteristics (1.8V).

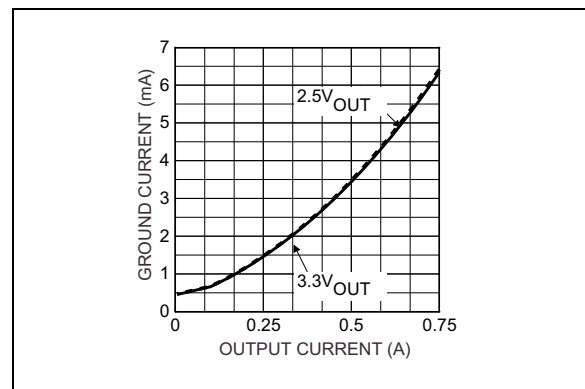

FIGURE 2-11: Ground Current vs. Output Current.

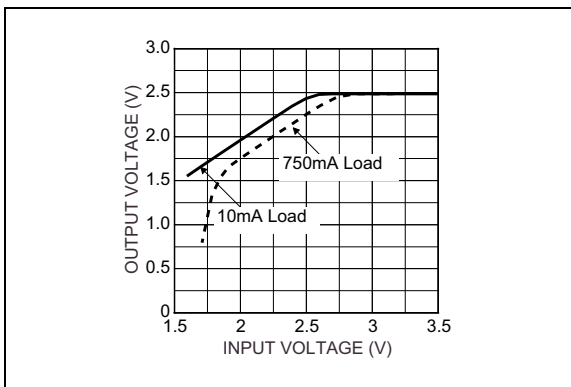

FIGURE 2-9: Dropout Characteristics (2.5V).

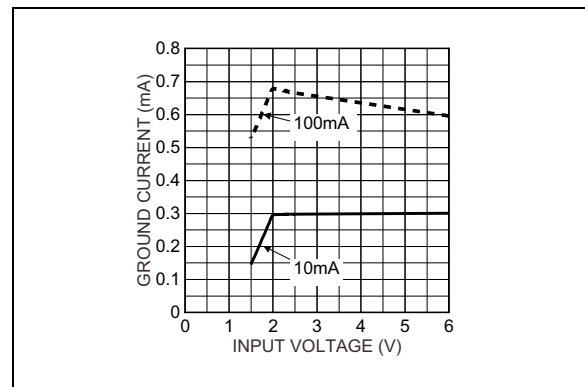

FIGURE 2-12: Ground Current vs. Supply Voltage (1.5V).

MIC3775

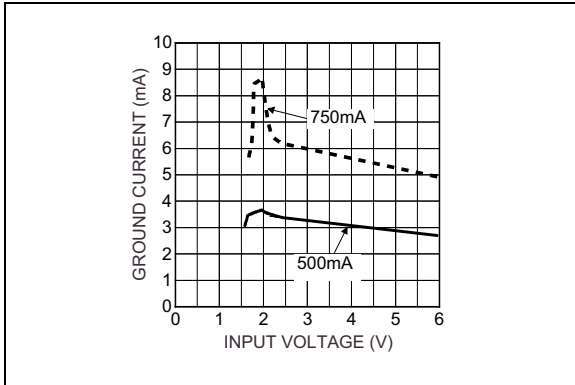

FIGURE 2-13: Ground Current vs. Supply Voltage (1.5V).

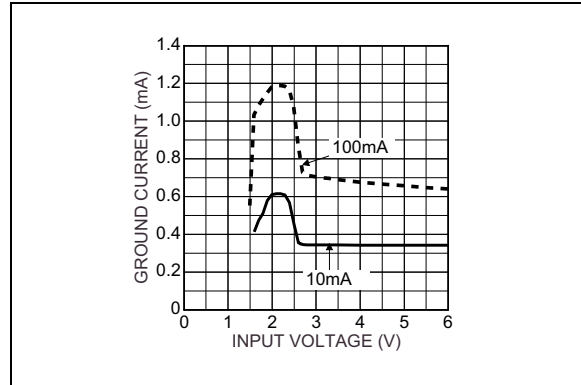

FIGURE 2-16: Ground Current vs. Supply Voltage (2.5V).

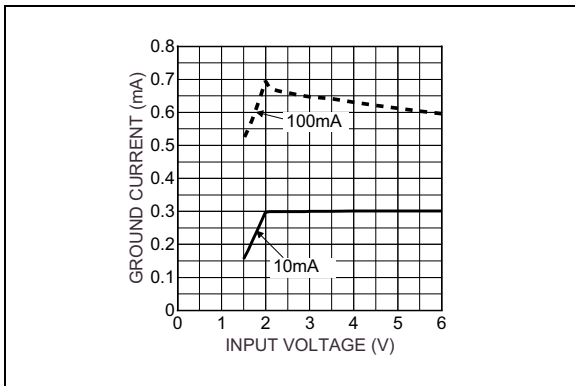

FIGURE 2-14: Ground Current vs. Supply Voltage (1.8V).

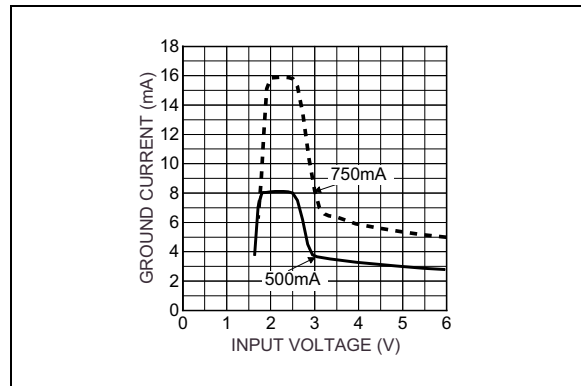

FIGURE 2-17: Ground Current vs. Supply Voltage (2.5V).

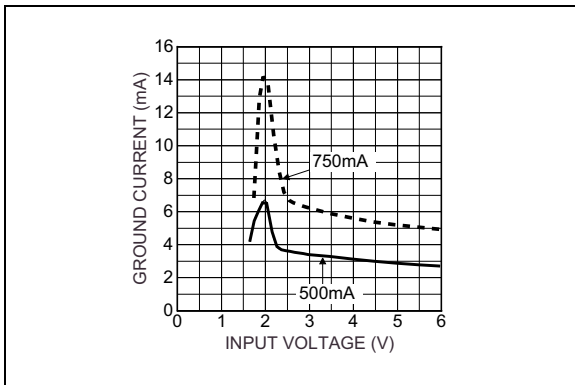

FIGURE 2-15: Ground Current vs. Supply Voltage (1.8V).

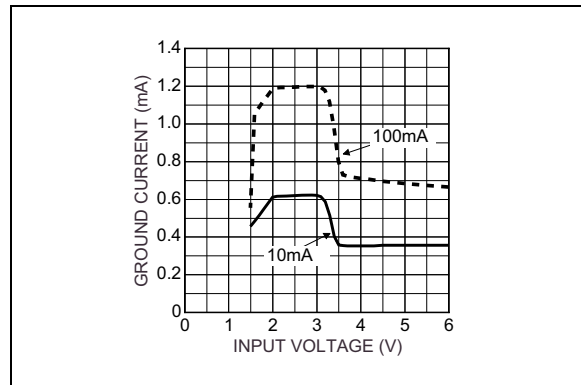

FIGURE 2-18: Ground Current vs. Supply Voltage (3.3V).

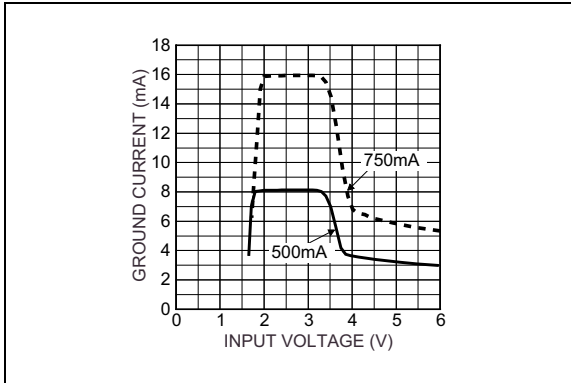

FIGURE 2-19: Ground Current vs. Supply Voltage (3.3V).

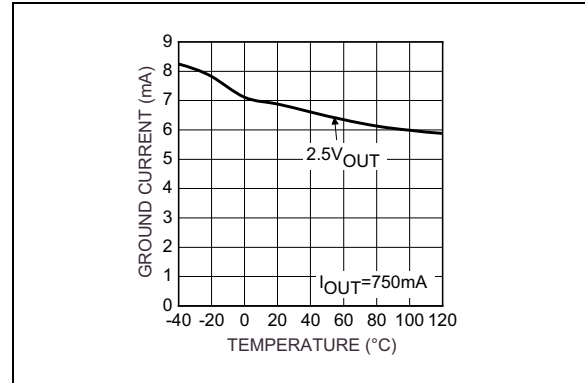

FIGURE 2-22: Ground Current vs. Temperature.

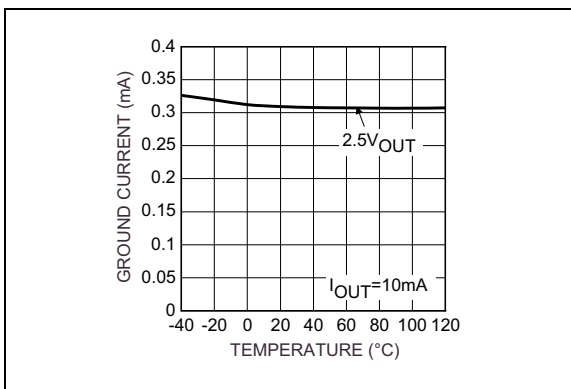

FIGURE 2-20: Ground Current vs. Temperature.

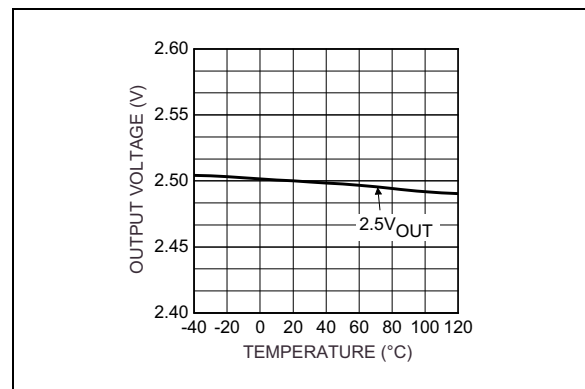

FIGURE 2-23: Output Voltage vs. Temperature.

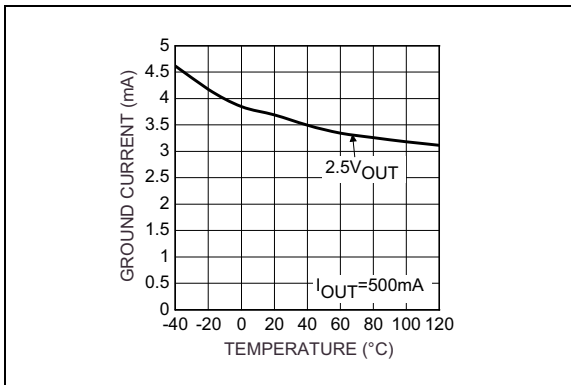

FIGURE 2-21: Ground Current vs. Temperature.

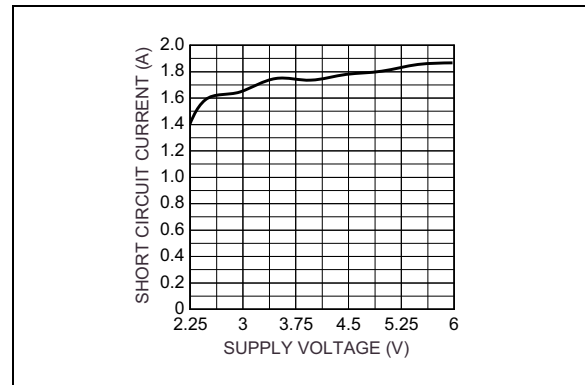

FIGURE 2-24: Short Circuit Current vs. Supply Voltage.

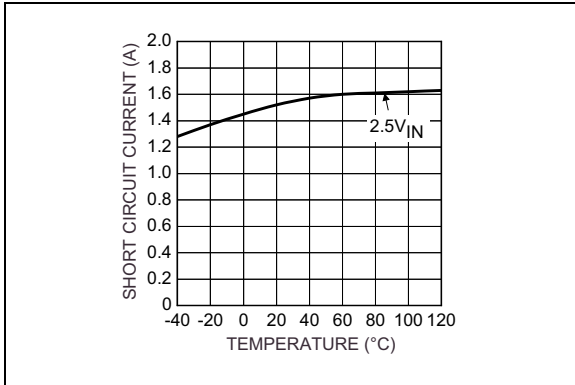

FIGURE 2-25: Short Circuit Current vs. Temperature.

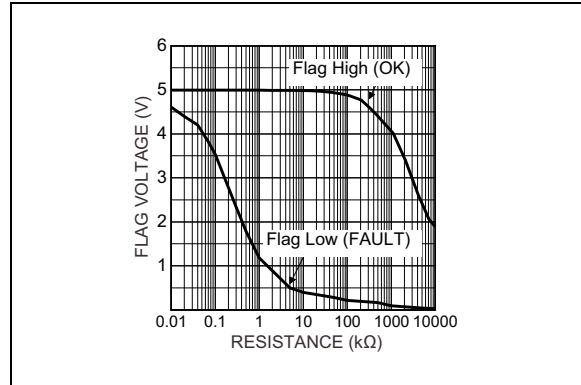

FIGURE 2-28: Error Flag Pull-Up Resistor.

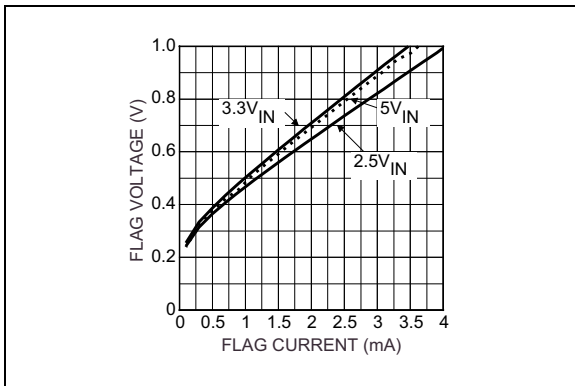

FIGURE 2-26: Flag Voltage vs. Flag Current.

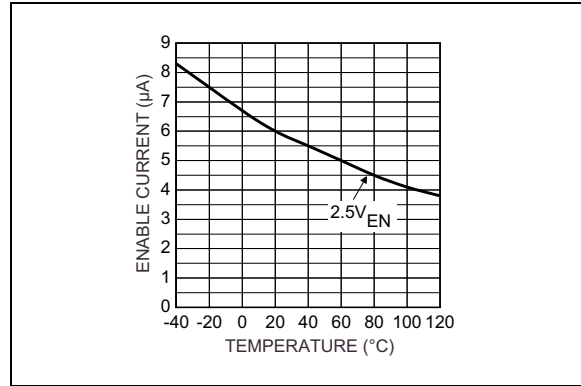

FIGURE 2-29: Enable Current vs. Temperature.

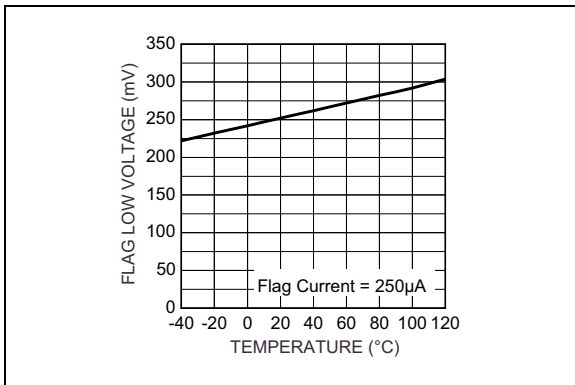

FIGURE 2-27: Flag Low Voltage vs. Temperature.

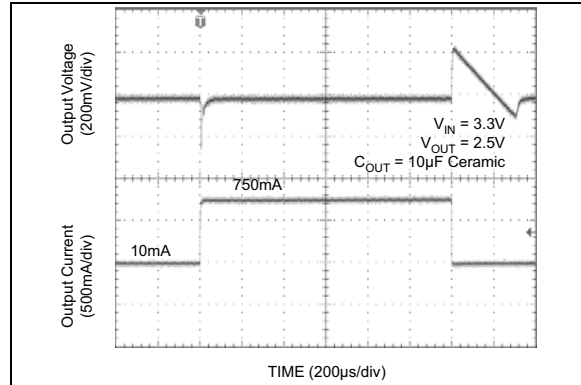

FIGURE 2-30: Load Transient Response.

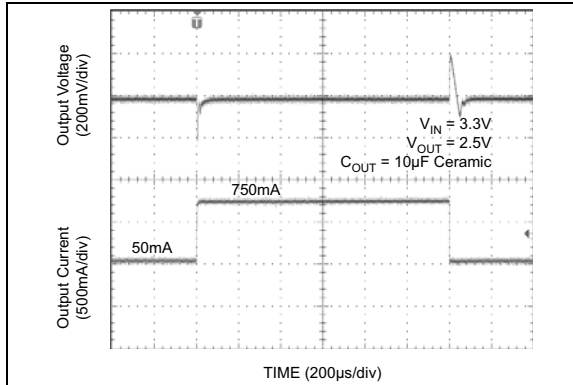

FIGURE 2-31: Load Transient Response.

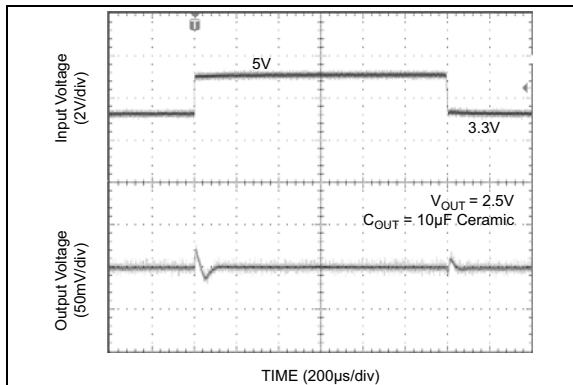

FIGURE 2-32: Line Transient Response.

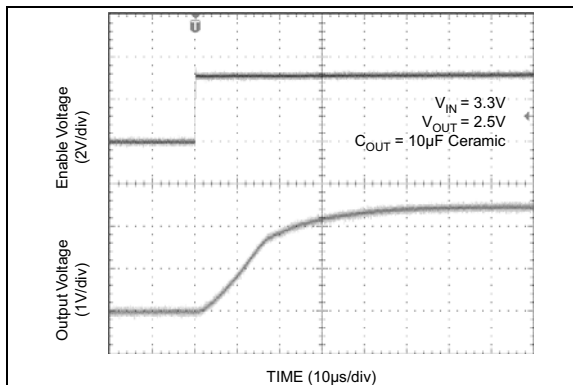

FIGURE 2-33: Enable Transient Response.

MIC3775

3.0 PIN DESCRIPTIONS

The descriptions of the pins are listed in [Table 3-1](#).

TABLE 3-1: PIN FUNCTION TABLE

Pin Number	Pin Name	Description
1	EN	Enable (Input): CMOS-compatible control input. Logic high = enable, logic low or open = shutdown. Do not leave this pin floating.
2	IN	Supply (Input).
3	FLG	Flag (Output): Open-collector error flag output. Active low = output undervoltage.
	ADJ	Adjustment Input: Feedback input. Connect to resistive voltage-divider network.
4	OUT	Regulator Output.
5 - 8	GND	Ground.

4.0 APPLICATION INFORMATION

The MIC3775 is a high-performance low-dropout voltage regulator suitable for moderate to high-current voltage regulator applications. Its 500 mV dropout voltage at full load and over temperature makes it especially valuable in battery-powered systems and as high-efficiency noise filters in post-regulator applications. Unlike older NPN-pass transistor designs, where the minimum dropout voltage is limited by the base-to-emitter voltage drop and collector-to-emitter saturation voltage, dropout performance of the PNP output of these devices is limited only by the low V_{CE} saturation voltage.

A trade-off for the low-dropout voltage is a varying base drive requirement. Microchip's SuperBeta PNP process reduces this drive requirement to only 2% of the load current.

The MIC3775 regulator is fully protected from damage due to fault conditions. Linear current limiting is provided. Output current during overload conditions is constant. Thermal shutdown disables the device when the die temperature exceeds the maximum safe operating temperature. The output structure of these regulators allows voltages in excess of the desired output voltage to be applied without reverse current flow.

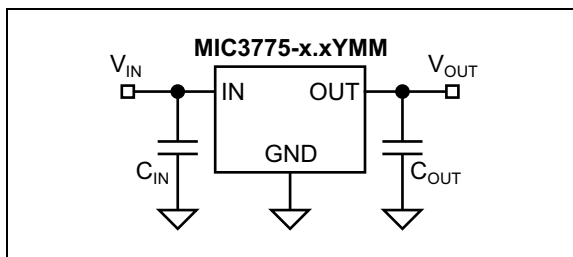

FIGURE 4-1: Capacitor Requirements.

4.1 Output Capacitor

The MIC3775 requires an output capacitor for stable operation. As a μ Cap LDO, the MIC3775 can operate with ceramic output capacitors as long as the amount of capacitance is 10 μ F or greater. For values of output capacitance lower than 10 μ F, the recommended ESR range is 200 m Ω to 2 Ω . The minimum value of output capacitance recommended for the MIC3775 is 4.7 μ F.

For 10 μ F or greater, the ESR range recommended is less than 1 Ω . Ultra-low ESR ceramic capacitors are recommended for output capacitance of 10 μ F or greater to help improve transient response and noise reduction at high frequency. X7R/X5R dielectric-type ceramic capacitors are recommended because of their temperature performance. X7R-type capacitors change capacitance by 15% over their operating temperature range and are the most stable type of ceramic capacitors. Z5U and Y5V dielectric capacitors change value by as much as 50% and 60%

respectively over their operating temperature ranges. To use a ceramic chip capacitor with Y5V dielectric, the value must be much higher than an X7R ceramic capacitor to ensure the same minimum capacitance over the equivalent operating temperature range.

4.2 Input Capacitor

An input capacitor of 1 μ F or greater is recommended when the device is more than 4 inches away from the bulk AC supply capacitance or when the supply is a battery. Small, surface mount, ceramic chip capacitors can be used for bypassing. Larger values will help to improve ripple rejection by bypassing the input to the regulator, further improving the integrity of the output voltage.

4.3 Error Flag

The MIC3775 features an error flag (FLG) that monitors the output voltage and signals an error condition when this voltage drops 5% below its expected value. The error flag is an open-collector output that pulls low under fault conditions and may sink up to 10 mA. Low output voltage signifies a number of possible problems, including an overcurrent fault (the device is in current limit) or low input voltage. The flag output is inoperative during overtemperature conditions. A pull-up resistor from FLG to either V_{IN} or V_{OUT} is required for proper operation. For information regarding the minimum and maximum values of pull-up resistance, refer to the graph in the [Typical Performance Curves](#) section of the data sheet.

4.4 Enable Input

The MIC3775 features an active-high enable input (EN) that allows on-off control of the regulator. Current drain reduces to "zero" when the device is shutdown, with only microamperes of leakage current. The EN input has TTL/CMOS compatible thresholds for simple logic interfacing. EN may be directly tied to V_{IN} and pulled up to the maximum supply voltage. Do not leave the Enable input pin floating.

4.5 Transient Response and 3.3V to 2.5V or 2.5V to 1.8V or 1.65V Conversion

The MIC3775 has excellent transient response to variations in input voltage and load current. The device has been designed to respond quickly to load current variations and input voltage variations. Large output capacitors are not required to obtain this performance. A standard 10 μ F output capacitor is all that is required. Larger values help to improve performance even further.

MIC3775

By virtue of its low dropout voltage, this device does not saturate into dropout as readily as similar NPN-based designs. When converting from 3.3V to 2.5V or 2.5V to 1.8V or 1.65V, the NPN-based regulators are already operating in dropout, with typical dropout requirements of 1.2V or greater. To convert down to 2.5V or 1.8V without operating in dropout, NPN-based regulators require an input voltage of 3.7V at the very least. The MIC3775 regulator will provide excellent performance with an input as low as 3.0V or 2.5V respectively. This gives the PNP-based regulators a distinct advantage over older, NPN-based linear regulators.

4.6 Minimum Load Current

The MIC3775 regulator is specified between finite loads. If the output current is too small, leakage currents dominate and the output voltage rises. A 10 mA minimum load current is necessary for proper regulation.

4.7 Adjustable Regulator Design

The MIC3775 allows programming the output voltage anywhere between 1.24V and the 6V maximum operating rating of the family. Two resistors are used. Resistors can be quite large, up to 1 MΩ, because of the very high input impedance and low bias current of the sense comparator.

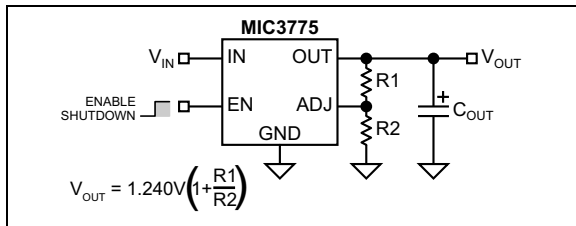

FIGURE 4-2: Adjustable Regulator with Resistors.

The resistor values are calculated by:

EQUATION 4-1:

$$R1 = R2 \left(\frac{V_{OUT}}{1.240} - 1 \right)$$

Where:
 V_{OUT} = The desired output voltage.

Figure 4-2 shows component definition. Applications with widely varying load currents may scale the resistors to draw the minimum load current required for proper operation.

4.8 Power MSOP-8 Thermal Characteristics

One of the secrets of the MIC3775's performance is its power MSOP-8 package that features half the thermal resistance of a standard MSOP-8 package. Lower thermal resistance means more output current or higher input voltage for a given package size.

Lower thermal resistance is achieved by joining the four ground leads with the die attach paddle to create a single-piece electrical and thermal conductor. This concept has been used by MOSFET manufacturers for years, proving very reliable and cost effective for the user.

Thermal resistance consists of two main elements, θ_{JC} (junction-to-case thermal resistance) and θ_{CA} (case-to-ambient thermal resistance). See Figure 4-3. θ_{JC} is the resistance from the die to the leads of the package. θ_{CA} is the resistance from the leads to the ambient air and it includes θ_{CS} (case-to-sink thermal resistance) and θ_{SA} (sink-to-ambient thermal resistance).

Using the power MSOP-8 reduces the θ_{JC} dramatically and allows the user to reduce θ_{CA} . The total thermal resistance, θ_{JA} (junction-to-ambient thermal resistance) is the limiting factor in calculating the maximum power dissipation capability of the device. Typically, the power MSOP-8 has a θ_{JA} of 80°C/W, which is significantly lower than the standard MSOP-8, which is typically 160°C/W. θ_{CA} is reduced because pins 5 through 8 can now be soldered directly to a ground plane, which significantly reduces the case-to-sink thermal resistance and sink-to-ambient thermal resistance.

Low-dropout linear regulators from Microchip are rated to a maximum junction temperature of 125°C. It is important not to exceed this maximum junction temperature during operation of the device. To prevent this maximum junction temperature from being exceeded, the appropriate ground plane heat sink must be used.

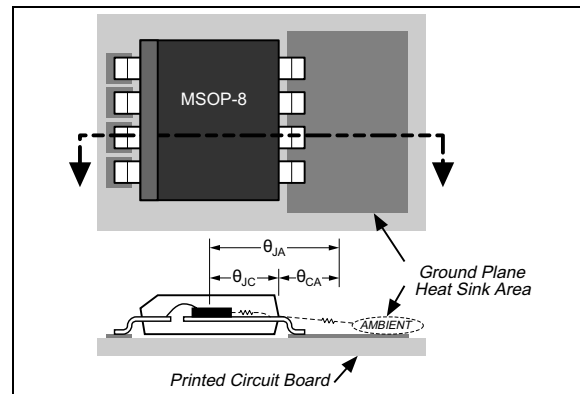

FIGURE 4-3: Thermal Resistance.

Figure 4-4 shows copper area versus power dissipation with each trace corresponding to a different temperature rise above ambient.

From these curves, the minimum area of copper necessary for the part to operate safely can be determined. The maximum allowable temperature rise must be calculated to determine operation along which curve.

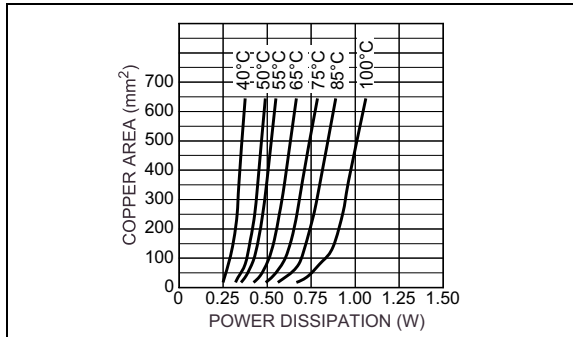

FIGURE 4-4: Copper Area vs. Power MSOP Power Dissipation (ΔT_{JA}).

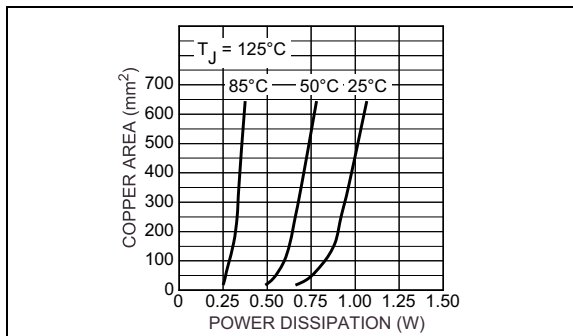

FIGURE 4-5: Copper Area vs. Power MSOP Power Dissipation (T_A).

EQUATION 4-2:

$$\Delta T = T_{J(MAX)} - T_{A(MAX)}$$

Where:

$$T_{J(MAX)} = 125^{\circ}\text{C}$$

$T_{A(MAX)}$ = The max. ambient operating temp.

For example, the maximum ambient temperature is 50°C , the ΔT is determined as follows:

EQUATION 4-3:

$$\Delta T = 125^{\circ}\text{C} - 50^{\circ}\text{C} = 75^{\circ}\text{C}$$

Using Figure 4-4, the minimum amount of required copper can be determined based on the required power dissipation. Power dissipation in a linear regulator is calculated as follows:

EQUATION 4-4:

$$P_D = (V_{IN} - V_{OUT}) \times I_{OUT} + V_{IN} \times I_{GND}$$

If using a 2.5V output device and a 3.3V input at an output current of 750 mA, then calculating power dissipation is as follows:

EQUATION 4-5:

$$P_D = (3.3\text{V} - 2.5\text{V}) \times 750\text{mA} + 3.3\text{V} \times 7.5\text{mA}$$

$$P_D = 600\text{mW} + 25\text{mW} = 625\text{mW}$$

From Figure 4-4, the minimum amount of copper required to operate this application at a ΔT of 75°C is 160mm^2 .

4.9 Quick Method

Determine the power dissipation requirements for the design along with the maximum ambient temperature at which the device will be operated. Refer to Figure 4-5, which shows safe operating curves for three different ambient temperatures: 25°C , 50°C , and 85°C . From these curves, the minimum amount of copper can be determined by knowing the maximum power dissipation required. If the maximum ambient temperature is 50°C and the power dissipation is 625 mW, the curve in Figure 4-5 shows that the required area of copper is 160mm^2 . The θ_{JA} of this package is ideally $80^{\circ}\text{C}/\text{W}$, but it will vary depending upon the availability of copper ground plane to which it is attached.

5.0 PACKAGING INFORMATION

5.1 Package Marking Information

8-Lead MSOP*
(Fixed)

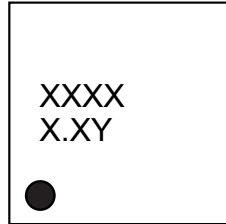

Example

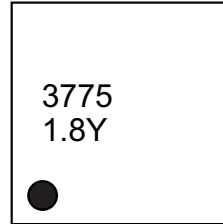

8-Lead MSOP*
(Adj.)

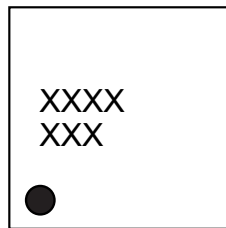

Example

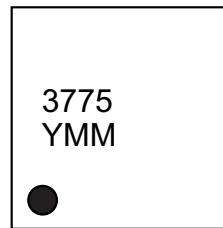

Legend:	XX...X	Product code or customer-specific information
	Y	Year code (last digit of calendar year)
	YY	Year code (last 2 digits of calendar year)
	WW	Week code (week of January 1 is week '01')
	NNN	Alphanumeric traceability code
	(e3)	Pb-free JEDEC® designator for Matte Tin (Sn)
	*	This package is Pb-free. The Pb-free JEDEC designator (e3) can be found on the outer packaging for this package.
	•, ▲, ▼	Pin one index is identified by a dot, delta up, or delta down (triangle mark).
Note:	In the event the full Microchip part number cannot be marked on one line, it will be carried over to the next line, thus limiting the number of available characters for customer-specific information. Package may or may not include the corporate logo.	
	Underbar (¯) and/or Overbar (˘) symbol may not be to scale.	

8-Lead MSOP Package Outline & Recommended Land Pattern

TITLE

8 LEAD MSOP PACKAGE OUTLINE & RECOMMENDED LAND PATTERN

DRAWING #	MSOP-8LD-PL-1	UNIT	INCH [MM]
-----------	---------------	------	-----------

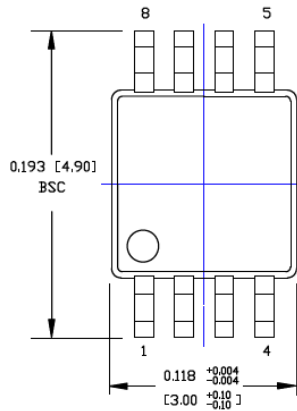

TOP VIEW

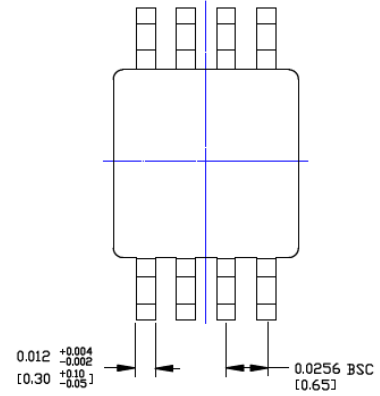

BOTTOM VIEW

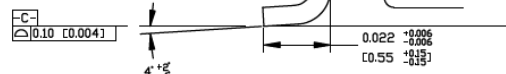

DETAIL A

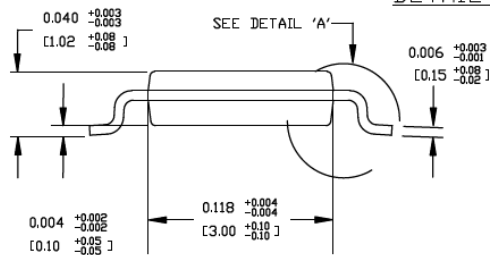

SIDE VIEW

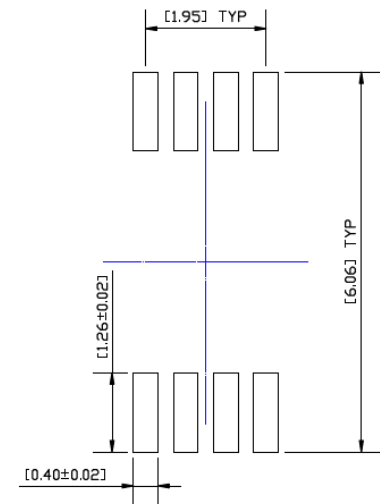

RECOMMENDED LAND PATTERN

NOTES:

1. DIMENSIONS ARE IN INCHES [MM].
2. CONTROLLING DIMENSION: MM
3. DIMENSION DOES NOT INCLUDE MOLD FLASH OR PROTRUSIONS, EITHER OF WHICH SHALL NOT EXCEED 0.008 [0.20] PER SIDE.

Note: For the most current package drawings, please see the Microchip Packaging Specification located at <http://www.microchip.com/packaging>.

MIC3775

NOTES:

APPENDIX A: REVISION HISTORY

Revision A (July 2018)

- Converted Micrel document MIC3775 to Microchip data sheet template DS20006045A.
- Minor grammatical text changes throughout.
- Typographical correction to the equation in [Figure 4-2](#).

MIC3775

NOTES:

PRODUCT IDENTIFICATION SYSTEM

To order or obtain information, e.g., on pricing or delivery, contact your local Microchip representative or sales office.

Device	-X.X	X	XX	-XX
Part No.	Output Voltage	Junction Temp. Range	Package	Media Type
Device:	MIC3775:	750 mA μ Cap Low Voltage, Low Dropout Regulator		
Output Voltage:	1.5 = 1.5V 1.65 = 1.65V 1.8 = 1.8V 2.5 = 2.5V 3.0 = 3.0V 3.3 = 3.3V <blank>= Adjustable			
Junction Temperature Range:	Y = -40°C to +125°C, RoHS-Compliant			
Package:	MM = 8-Lead MSOP			
Media Type:	<blank>= 100/Tube TR = 2,500/Reel			
Examples:				
a) MIC3775-1.5YMM-TR: MIC3775, 1.5V Output Voltage, -40°C to +125°C Temperature Range, 8-Lead MSOP, 2,500/Reel				
b) MIC3775-1.65YMM: MIC3775, 1.65V Output Voltage, -40°C to +125°C Temperature Range, 8-Lead MSOP, 100/Tube				
c) MIC3775-1.8YMM-TR: MIC3775, 1.8V Output Voltage, -40°C to +125°C Temperature Range, 8-Lead MSOP, 2,500/Reel				
d) MIC3775-2.5YMM: MIC3775, 2.5V Output Voltage, -40°C to +125°C Temperature Range, 8-Lead MSOP, 100/Tube				
e) MIC3775-3.0YMM-TR: MIC3775, 3.0V Output Voltage, -40°C to +125°C Temperature Range, 8-Lead MSOP, 2,500/Reel				
f) MIC3775-3.3YMM: MIC3775, 3.3V Output Voltage, -40°C to +125°C Temperature Range, 8-Lead MSOP, 100/Tube				
g) MIC3775YMM-TR: MIC3775, Adjustable Output Voltage, -40°C to +125°C Temperature Range, 8-Lead MSOP, 2,500/Reel				
Note 1: Tape and Reel identifier only appears in the catalog part number description. This identifier is used for ordering purposes and is not printed on the device package. Check with your Microchip Sales Office for package availability with the Tape and Reel option.				

MIC3775

NOTES:

Note the following details of the code protection feature on Microchip devices:

- Microchip products meet the specification contained in their particular Microchip Data Sheet.
- Microchip believes that its family of products is one of the most secure families of its kind on the market today, when used in the intended manner and under normal conditions.
- There are dishonest and possibly illegal methods used to breach the code protection feature. All of these methods, to our knowledge, require using the Microchip products in a manner outside the operating specifications contained in Microchip's Data Sheets. Most likely, the person doing so is engaged in theft of intellectual property.
- Microchip is willing to work with the customer who is concerned about the integrity of their code.
- Neither Microchip nor any other semiconductor manufacturer can guarantee the security of their code. Code protection does not mean that we are guaranteeing the product as “unbreakable.”

Code protection is constantly evolving. We at Microchip are committed to continuously improving the code protection features of our products. Attempts to break Microchip's code protection feature may be a violation of the Digital Millennium Copyright Act. If such acts allow unauthorized access to your software or other copyrighted work, you may have a right to sue for relief under that Act.

Information contained in this publication regarding device applications and the like is provided only for your convenience and may be superseded by updates. It is your responsibility to ensure that your application meets with your specifications. MICROCHIP MAKES NO REPRESENTATIONS OR WARRANTIES OF ANY KIND WHETHER EXPRESS OR IMPLIED, WRITTEN OR ORAL, STATUTORY OR OTHERWISE, RELATED TO THE INFORMATION, INCLUDING BUT NOT LIMITED TO ITS CONDITION, QUALITY, PERFORMANCE, MERCHANTABILITY OR FITNESS FOR PURPOSE. Microchip disclaims all liability arising from this information and its use. Use of Microchip devices in life support and/or safety applications is entirely at the buyer's risk, and the buyer agrees to defend, indemnify and hold harmless Microchip from any and all damages, claims, suits, or expenses resulting from such use. No licenses are conveyed, implicitly or otherwise, under any Microchip intellectual property rights unless otherwise stated.

Microchip received ISO/TS-16949:2009 certification for its worldwide headquarters, design and wafer fabrication facilities in Chandler and Tempe, Arizona; Gresham, Oregon and design centers in California and India. The Company's quality system processes and procedures are for its PIC® MCUs and dsPIC® DSCs, KEELOQ® code hopping devices, Serial EEPROMs, microperipherals, nonvolatile memory and analog products. In addition, Microchip's quality system for the design and manufacture of development systems is ISO 9001:2000 certified.

**QUALITY MANAGEMENT SYSTEM
CERTIFIED BY DNV
= ISO/TS 16949 =**

Trademarks

The Microchip name and logo, the Microchip logo, AnyRate, AVR, AVR logo, AVR Freaks, BitCloud, chipKIT, chipKIT logo, CryptoMemory, CryptoRF, dsPIC, FlashFlex, flexPWR, Heldo, JukeBlox, KeeLoq, Kleer, LANCheck, LINK MD, maXStylus, maXTouch, MediaLB, megaAVR, MOST, MOST logo, MPLAB, OptoLyzer, PIC, picoPower, PICSTART, PIC32 logo, Prochip Designer, QTouch, SAM-BA, SpyNIC, SST, SST Logo, SuperFlash, tinyAVR, UNI/O, and XMEGA are registered trademarks of Microchip Technology Incorporated in the U.S.A. and other countries.

ClockWorks, The Embedded Control Solutions Company, EtherSynch, Hyper Speed Control, HyperLight Load, IntellIMOS, mTouch, Precision Edge, and Quiet-Wire are registered trademarks of Microchip Technology Incorporated in the U.S.A.

Adjacent Key Suppression, AKS, Analog-for-the-Digital Age, Any Capacitor, AnyIn, AnyOut, BodyCom, CodeGuard, CryptoAuthentication, CryptoAutomotive, CryptoCompanion, CryptoController, dsPICDEM, dsPICDEM.net, Dynamic Average Matching, DAM, ECAN, EtherGREEN, In-Circuit Serial Programming, ICSP, INICnet, Inter-Chip Connectivity, JitterBlocker, KleerNet, KleerNet logo, memBrain, Mindi, MiWi, motorBench, MPASM, MPF, MPLAB Certified logo, MPLIB, MPLINK, MultiTRAK, NetDetach, Omniscient Code Generation, PICDEM, PICDEM.net, PICKit, PICtail, PowerSmart, PureSilicon, QMatrix, REAL ICE, Ripple Blocker, SAM-ICE, Serial Quad I/O, SMART-I.S., SQI, SuperSwitcher, SuperSwitcher II, Total Endurance, TSHARC, USBCheck, VariSense, ViewSpan, WiperLock, Wireless DNA, and ZENA are trademarks of Microchip Technology Incorporated in the U.S.A. and other countries.

SQTP is a service mark of Microchip Technology Incorporated in the U.S.A.

Silicon Storage Technology is a registered trademark of Microchip Technology Inc. in other countries.

GestIC is a registered trademark of Microchip Technology Germany II GmbH & Co. KG, a subsidiary of Microchip Technology Inc., in other countries.

All other trademarks mentioned herein are property of their respective companies.

© 2018, Microchip Technology Incorporated, All Rights Reserved.
ISBN: 978-1-5224-3313-2



MICROCHIP

Worldwide Sales and Service

AMERICAS

Corporate Office
2355 West Chandler Blvd.
Chandler, AZ 85224-6199
Tel: 480-792-7200
Fax: 480-792-7277
Technical Support:
<http://www.microchip.com/support>
Web Address:
www.microchip.com

Atlanta

Duluth, GA
Tel: 678-957-9614
Fax: 678-957-1455

Austin, TX

Tel: 512-257-3370

Boston

Westborough, MA
Tel: 774-760-0087
Fax: 774-760-0088

Chicago

Itasca, IL
Tel: 630-285-0071
Fax: 630-285-0075

Dallas

Addison, TX
Tel: 972-818-7423
Fax: 972-818-2924

Detroit

Novi, MI
Tel: 248-848-4000

Houston, TX

Tel: 281-894-5983

Indianapolis

Noblesville, IN
Tel: 317-773-8323
Fax: 317-773-5453
Tel: 317-536-2380

Los Angeles

Mission Viejo, CA
Tel: 949-462-9523
Fax: 949-462-9608
Tel: 951-273-7800

Raleigh, NC

Tel: 919-844-7510

New York, NY

Tel: 631-435-6000

San Jose, CA

Tel: 408-735-9110
Tel: 408-436-4270

Canada - Toronto

Tel: 905-695-1980
Fax: 905-695-2078

ASIA/PACIFIC

Australia - Sydney
Tel: 61-2-9868-6733

China - Beijing
Tel: 86-10-8569-7000

China - Chengdu
Tel: 86-28-8665-5511

China - Chongqing
Tel: 86-23-8980-9588

China - Dongguan
Tel: 86-769-8702-9880

China - Guangzhou
Tel: 86-20-8755-8029

China - Hangzhou
Tel: 86-571-8792-8115

China - Hong Kong SAR
Tel: 852-2943-5100

China - Nanjing
Tel: 86-25-8473-2460

China - Qingdao
Tel: 86-532-8502-7355

China - Shanghai
Tel: 86-21-3326-8000

China - Shenyang
Tel: 86-24-2334-2829

China - Shenzhen
Tel: 86-755-8864-2200

China - Suzhou
Tel: 86-186-6233-1526

China - Wuhan
Tel: 86-27-5980-5300

China - Xian
Tel: 86-29-8833-7252

China - Xiamen
Tel: 86-592-2388138

China - Zhuhai
Tel: 86-756-3210040

ASIA/PACIFIC

India - Bangalore
Tel: 91-80-3090-4444

India - New Delhi
Tel: 91-11-4160-8631

India - Pune
Tel: 91-20-4121-0141

Japan - Osaka
Tel: 81-6-6152-7160

Japan - Tokyo
Tel: 81-3-6880-3770

Korea - Daegu
Tel: 82-53-744-4301

Korea - Seoul
Tel: 82-2-554-7200

Malaysia - Kuala Lumpur
Tel: 60-3-7651-7906

Malaysia - Penang
Tel: 60-4-227-8870

Philippines - Manila
Tel: 63-2-634-9065

Singapore
Tel: 65-6334-8870

Taiwan - Hsin Chu
Tel: 886-3-577-8366

Taiwan - Kaohsiung
Tel: 886-7-213-7830

Taiwan - Taipei
Tel: 886-2-2508-8600

Thailand - Bangkok
Tel: 66-2-694-1351

Vietnam - Ho Chi Minh
Tel: 84-28-5448-2100

EUROPE

Austria - Wels
Tel: 43-7242-2244-39
Fax: 43-7242-2244-393

Denmark - Copenhagen
Tel: 45-4450-2828
Fax: 45-4485-2829

Finland - Espoo
Tel: 358-9-4520-820

France - Paris
Tel: 33-1-69-53-63-20
Fax: 33-1-69-30-90-79

Germany - Garching
Tel: 49-8931-9700

Germany - Haan
Tel: 49-2129-3766400

Germany - Heilbronn
Tel: 49-7131-67-3636

Germany - Karlsruhe
Tel: 49-721-625370

Germany - Munich
Tel: 49-89-627-144-0
Fax: 49-89-627-144-44

Germany - Rosenheim
Tel: 49-8031-354-560

Israel - Ra'anana
Tel: 972-9-744-7705

Italy - Milan
Tel: 39-0331-742611
Fax: 39-0331-466781

Italy - Padova
Tel: 39-049-7625286

Netherlands - Drunen
Tel: 31-416-690399
Fax: 31-416-690340

Norway - Trondheim
Tel: 47-7289-7561

Poland - Warsaw
Tel: 48-22-3325737

Romania - Bucharest
Tel: 40-21-407-87-50

Spain - Madrid
Tel: 34-91-708-08-90
Fax: 34-91-708-08-91

Sweden - Gothenberg
Tel: 46-31-704-60-40

Sweden - Stockholm
Tel: 46-8-5090-4654

UK - Wokingham
Tel: 44-118-921-5800
Fax: 44-118-921-5820