

Dual mode low power 150 mW stereo headphone amplifier with capacitor-less and single-ended outputs

Datasheet – production data

Features

- No output coupling capacitors necessary
- Pop-and-click noise reduction circuitry
- Operating from $V_{CC} = 2.2\text{ V}$ to 5.5 V
- Standby mode active low
- Output power:
 - 158 mW at 5 V, into $16\ \Omega$ with 1% THD+N max (1 kHz)
 - 52 mW at 3.0 V into $16\ \Omega$ with 1% THD+N max (1 kHz)
- Ultra-low current consumption: 2.0 mA typ. at 3 V
- Ultra-low standby consumption: 10 nA typ.
- High signal-to-noise ratio: 105 dB typ. at 5 V
- High crosstalk immunity: 110 dB ($F = 1\text{ kHz}$) for single-ended outputs
- PSRR: 72 dB ($F = 1\text{ kHz}$), inputs grounded, for phantom ground outputs
- Low t_{WU} : 50 ms in PG mode, 100 ms in SE mode
- Available in lead-free DFN10 3 x 3 mm

Applications

- Headphone amplifier
- Mobile phone
- PDA, portable audio player

Description

The TS4909 is a stereo audio amplifier designed to drive headphones in portable applications. The integrated phantom ground is a circuit topology that eliminates the heavy output coupling capacitors. This is of primary importance in portable applications where space constraints are very high. A single-ended configuration is also available, offering even lower power consumption because the phantom ground can be switched off. Pop-and-click noise during switch-on and switch-off phases is eliminated by integrated circuitry.

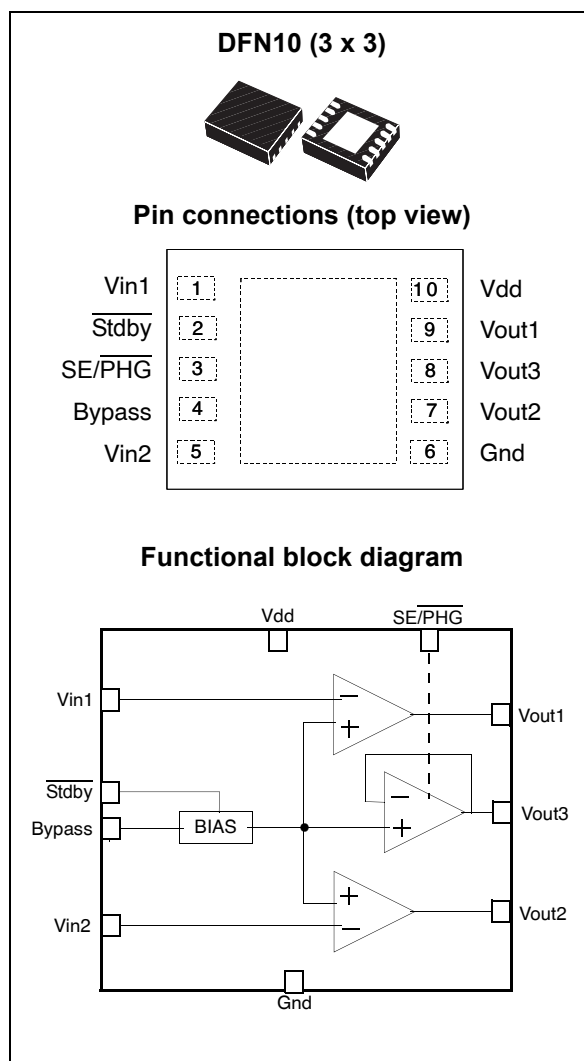

Specially designed for applications requiring low power supplies, the TS4909 is capable of delivering 31 mW of continuous average power into a $32\ \Omega$ load with less than 1% THD+N from a 3 V power supply. Featuring an active low standby mode, the TS4909 reduces the supply current to only 10 nA (typ.). The TS4909 is unity gain stable and can be configured by external gain-setting resistors.

Contents

1 Typical application schematics 5

2 Absolute maximum ratings and operating conditions 6

3 Electrical characteristics 7

4 Application information 23

4.1 General description 23

4.2 Frequency response 23

4.3 Gain using the typical application schematics 24

4.4 Power dissipation and efficiency 25

4.4.1 Single-ended configuration 25

4.4.2 Phantom ground configuration 26

4.4.3 Total power dissipation 27

4.5 Decoupling of the circuit 27

4.6 Wake-up time 28

4.7 Pop performance 28

4.8 Standby mode 29

5 Package information 30

6 Ordering information 33

7 Revision history 34

List of figures

Figure 1.	Typical applications for the TS4909	4
Figure 2.	Open-loop frequency response, $R_L = 1 \text{ M}\Omega$	9
Figure 3.	Open-loop frequency response, $R_L = 100 \text{ }\Omega$, $C_L = 400 \text{ pF}$	9
Figure 4.	Open-loop frequency response, $R_L = 1 \text{ M}\Omega$, $C_L = 100 \text{ pF}$	9
Figure 5.	Open-loop frequency response, $R_L = 16 \text{ }\Omega$	9
Figure 6.	Open-loop frequency response, $R_L = 16 \text{ }\Omega$, $C_L = 400 \text{ pF}$	9
Figure 7.	Output swing vs. power supply voltage	9
Figure 8.	THD+N vs. output power, PHG, $F = 1 \text{ kHz}$, $R_L = 16 \text{ }\Omega$, $A_v = 1$	10
Figure 9.	THD+N vs. output power, PHG, $F = 20 \text{ kHz}$, $R_L = 16 \text{ }\Omega$, $A_v = 1$	10
Figure 10.	THD+N vs. output power, PHG, $F = 1 \text{ kHz}$, $R_L = 32 \text{ }\Omega$, $A_v = 1$	10
Figure 11.	THD+N vs. output power, PHG, $F = 20 \text{ kHz}$, $R_L = 32 \text{ }\Omega$, $A_v = 1$	10
Figure 12.	THD+N vs. output power, SE, $F = 1 \text{ kHz}$, $R_L = 16 \text{ }\Omega$, $A_v = 1$	10
Figure 13.	THD+N vs. output power, SE, $F = 20 \text{ kHz}$, $R_L = 16 \text{ }\Omega$, $A_v = 1$	10
Figure 14.	THD+N vs. output power, SE, $F = 1 \text{ kHz}$, $R_L = 32 \text{ }\Omega$, $A_v = 1$	11
Figure 15.	THD+N vs. output power, SE, $F = 20 \text{ kHz}$, $R_L = 32 \text{ }\Omega$, $A_v = 1$	11
Figure 16.	THD+N vs. output power, PHG, $F = 1 \text{ kHz}$, $R_L = 16 \text{ }\Omega$, $A_v = 4$	11
Figure 17.	THD+N vs. output power, PHG, $F = 20 \text{ kHz}$, $R_L = 16 \text{ }\Omega$, $A_v = 4$	11
Figure 18.	THD+N vs. output power, PHG, $F = 1 \text{ kHz}$, $R_L = 32 \text{ }\Omega$, $A_v = 4$	11
Figure 19.	THD+N vs. output power, PHG, $F = 20 \text{ kHz}$, $R_L = 32 \text{ }\Omega$, $A_v = 4$	11
Figure 20.	THD+N vs. output power, SE, $F = 1 \text{ kHz}$, $R_L = 16 \text{ }\Omega$, $A_v = 4$	12
Figure 21.	THD+N vs. output power, SE, $F = 20 \text{ kHz}$, $R_L = 16 \text{ }\Omega$, $A_v = 4$	12
Figure 22.	THD+N vs. output power, SE, $F = 1 \text{ kHz}$, $R_L = 32 \text{ }\Omega$, $A_v = 4$	12
Figure 23.	THD+N vs. output power, SE, $F = 20 \text{ kHz}$, $R_L = 32 \text{ }\Omega$, $A_v = 4$	12
Figure 24.	THD+N vs. frequency, PHG, $R_L = 16 \text{ }\Omega$, $A_v = 1$	12
Figure 25.	THD+N vs. frequency, PHG, $R_L = 32 \text{ }\Omega$, $A_v = 1$	12
Figure 26.	THD+N vs. frequency, SE, $R_L = 16 \text{ }\Omega$, $A_v = 1$	13
Figure 27.	THD+N vs. frequency, SE, $R_L = 32 \text{ }\Omega$, $A_v = 1$	13
Figure 28.	THD+N vs. frequency, PHG, $R_L = 16 \text{ }\Omega$, $A_v = 4$	13
Figure 29.	THD+N vs. frequency, PHG, $R_L = 32 \text{ }\Omega$, $A_v = 4$	13
Figure 30.	THD+N vs. frequency, SE, $R_L = 16 \text{ }\Omega$, $A_v = 4$	13
Figure 31.	THD+N vs. frequency, SE, $R_L = 32 \text{ }\Omega$, $A_v = 4$	13
Figure 32.	Output power vs. power supply voltage, PHG, $R_L = 16 \text{ }\Omega$, $F = 1 \text{ kHz}$	14
Figure 33.	Output power vs. power supply voltage, PHG, $R_L = 32 \text{ }\Omega$, $F = 1 \text{ kHz}$	14
Figure 34.	Output power vs. power supply voltage, SE, $R_L = 16 \text{ }\Omega$, $F = 1 \text{ kHz}$	14
Figure 35.	Output power vs. power supply voltage, SE, $R_L = 32 \text{ }\Omega$, $F = 1 \text{ kHz}$	14
Figure 36.	Output power vs. load resistance, PHG, $V_{CC} = 2.6 \text{ V}$	14
Figure 37.	Output power vs. load resistance, SE, $V_{CC} = 2.6 \text{ V}$	14
Figure 38.	Output power vs. load resistance, PHG, $V_{CC} = 3 \text{ V}$	15
Figure 39.	Output power vs. load resistance, SE, $V_{CC} = 3 \text{ V}$	15
Figure 40.	Output power vs. load resistance, PHG, $V_{CC} = 5 \text{ V}$	15
Figure 41.	Output power vs. load resistance, SE, $V_{CC} = 5 \text{ V}$	15
Figure 42.	Power dissipation vs. output power, PHG, $V_{CC} = 2.6 \text{ V}$	15
Figure 43.	Power dissipation vs. output power, SE, $V_{CC} = 2.6 \text{ V}$	15
Figure 44.	Power dissipation vs. output power, PHG, $V_{CC} = 3 \text{ V}$	16
Figure 45.	Power dissipation vs. output power, SE, $V_{CC} = 3 \text{ V}$	16
Figure 46.	Power dissipation vs. output power, PHG, $V_{CC} = 5 \text{ V}$	16
Figure 47.	Power dissipation vs. output power, SE, $V_{CC} = 5 \text{ V}$	16
Figure 48.	Crosstalk vs. frequency, SE, $V_{CC} = 5 \text{ V}$, $R_L = 16 \text{ }\Omega$, $A_v = 1$	16

Figure 49.	Crosstalk vs. frequency, SE, $V_{CC} = 5\text{ V}$, $R_L = 32\ \Omega$, $A_v = 1$	16
Figure 50.	Crosstalk vs. frequency, SE, $V_{CC} = 5\text{ V}$, $R_L = 16\ \Omega$, $A_v = 4$	17
Figure 51.	Crosstalk vs. frequency, SE, $V_{CC} = 5\text{ V}$, $R_L = 32\ \Omega$, $A_v = 4$	17
Figure 52.	Crosstalk vs. frequency, PHG, $V_{CC} = 5\text{ V}$, $A_v = 1$	17
Figure 53.	Crosstalk vs. frequency, PHG, $V_{CC} = 5\text{ V}$, $A_v = 4$	17
Figure 54.	SNR vs. power supply voltage, PHG, unweighted, $A_v = 1$	17
Figure 55.	SNR vs. power supply voltage, SE, unweighted, $A_v = 1$	17
Figure 56.	SNR vs. power supply voltage, PHG, A-weighted, $A_v = 1$	18
Figure 57.	SNR vs. power supply voltage, SE, A-weighted, $A_v = 1$	18
Figure 58.	SNR vs. power supply voltage, PHG, unweighted, $A_v = 4$	18
Figure 59.	SNR vs. power supply voltage, SE, unweighted, $A_v = 4$	18
Figure 60.	SNR vs. power supply voltage, PHG, A-weighted, $A_v = 4$	18
Figure 61.	SNR vs. power supply voltage, SE, A-weighted, $A_v = 4$	18
Figure 62.	Power supply rejection ratio vs. frequency vs. V_{CC} , PHG	19
Figure 63.	Power supply rejection ratio vs. frequency vs. V_{CC} , SE	19
Figure 64.	Power supply rejection ratio vs. frequency vs. gain, PHG	19
Figure 65.	Power supply rejection ratio vs. frequency vs. gain, SE	19
Figure 66.	PSRR vs. frequency vs. bypass capacitor, PHG	19
Figure 67.	PSRR vs. frequency vs. bypass capacitor, SE	19
Figure 68.	Current consumption vs. power supply voltage, PHG	20
Figure 69.	Current consumption vs. power supply voltage, SE	20
Figure 70.	Current consumption vs. standby voltage, $V_{CC} = 2.6\text{ V}$, PHG	20
Figure 71.	Current consumption vs. standby voltage, $V_{CC} = 2.6\text{ V}$, SE	20
Figure 72.	Current consumption vs. standby voltage, $V_{CC} = 3\text{ V}$, PHG	20
Figure 73.	Current consumption vs. standby voltage, $V_{CC} = 3\text{ V}$, SE	20
Figure 74.	Current consumption vs. standby voltage, $V_{CC} = 5\text{ V}$, PHG	21
Figure 75.	Current consumption vs. standby voltage, $V_{CC} = 5\text{ V}$, SE	21
Figure 76.	Power derating curves	21
Figure 77.	Higher cut-off frequency vs. feedback capacitor	22
Figure 78.	Lower cut-off frequency vs. input capacitor	23
Figure 79.	Lower cut-off frequency vs. output capacitor	23
Figure 80.	Current delivered by power supply voltage in single-ended configuration	24
Figure 81.	Current delivered by power supply voltage in phantom ground configuration	25
Figure 82.	Typical wake-up time vs. bypass capacitance	27
Figure 83.	Internal equivalent circuit schematics of the TS4909 in standby mode	28
Figure 84.	TS4909 footprint recommendation	29
Figure 85.	DFN10 3 x 3 pitch 0.5 mm exposed pad package mechanical drawing	30

1 Typical application schematics

Figure 1. Typical applications for the TS4909

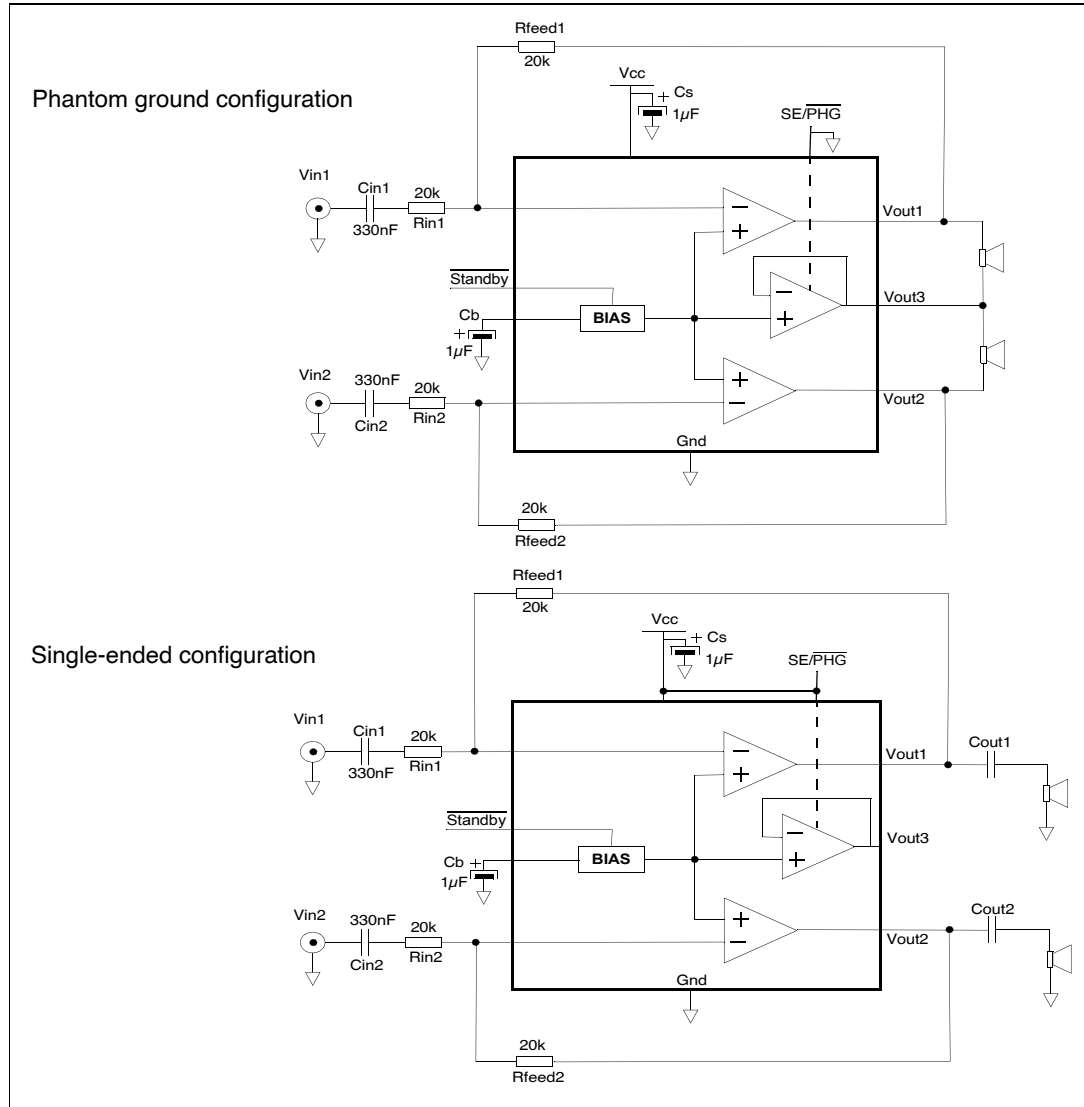

Table 1. Application component information

Component	Functional description
$R_{in1,2}$	Inverting input resistor that sets the closed loop gain in conjunction with R_{feed} . This resistor also forms a high pass filter with C_{in} ($f_c = 1 / (2 \times \pi \times R_{in} \times C_{in})$).
$C_{in1,2}$	Input coupling capacitor that blocks the DC voltage at the amplifier's input terminal.
$R_{feed1,2}$	Feedback resistor that sets the closed loop gain in conjunction with R_{in} . $A_V = \text{closed loop gain} = -R_{feed}/R_{in}$.
C_b	Half supply bypass capacitor
C_s	Supply bypass capacitor that provides power supply filtering.

2 Absolute maximum ratings and operating conditions

Table 2. Absolute maximum ratings

Symbol	Parameter	Value	Unit
V _{CC}	Supply voltage ⁽¹⁾	6	V
V _i	Input voltage	-0.3V to V _{CC} +0.3V	V
T _{stg}	Storage temperature	-65 to +150	°C
T _j	Maximum junction temperature	150	°C
R _{thja}	Thermal resistance junction to ambient DFN10	120	°C/W
P _{diss}	Power dissipation ⁽²⁾ DFN10	1.79	W
ESD	Human body model (pin to pin)	2	kV
ESD	Machine model 220pF - 240pF (pin to pin)	200	V
Latch-up	Latch-up immunity (all pins)	200	mA
	Lead temperature (soldering, 10 sec)	260	°C
	Output current	170 ⁽³⁾	mA

1. All voltage values are measured with respect to the ground pin.
2. P_d is calculated with T_{amb} = 25°C, T_{junction} = 150°C.
3. Caution: this device is not protected in the event of abnormal operating conditions, such as for example, short-circuiting between any one output pin and ground, between any one output pin and V_{CC}, and between individual output pins.

Table 3. Operating conditions

Symbol	Parameter	Value	Unit
V _{CC}	Supply voltage	2.2 to 5.5	V
R _L	Load resistor	≥ 16	Ω
T _{oper}	Operating free air temperature range	-40 to + 85	°C
C _L	Load capacitor R _L = 16 to 100Ω R _L > 100Ω	400 100	pF
V _{STBY}	Standby voltage input TS4909 in STANDBY TS4909 in active state	GND ≤ V _{STBY} ≤ 0.4 ⁽¹⁾ 1.35V ≤ V _{STBY} ≤ V _{CC}	V
V _{SE/PHG}	Single-ended or phantom ground configuration voltage input TS4909 outputs in single-ended configuration TS4909 outputs in phantom ground configuration	V _{SE/PHG} = V _{CC} V _{SE/PHG} = 0	V
R _{thja}	Thermal resistance junction-to-ambient DFN10 ⁽²⁾	41	°C/W

1. The minimum current consumption (I_{STBY}) is guaranteed at ground for the whole temperature range.
2. When mounted on a 4-layer PCB.

3 Electrical characteristics

Table 4. Electrical characteristics at $V_{CC} = +5\text{ V}$ with $GND = 0\text{ V}$ and $T_{amb} = 25^\circ\text{C}$ (unless otherwise specified)

Symbol	Parameter	Test conditions	Min.	Typ.	Max.	Unit
I_{CC}	Supply current	No input signal, no load, single-ended No input signal, no load, phantom ground		2.1 3.1	3.2 4.8	mA
I_{STBY}	Standby current	No input signal, $R_L = 32\Omega$		10	1000	nA
P_{out}	Output power	THD+N = 1% max, $F = 1\text{kHz}$, $R_L = 32\Omega$, single-ended THD+N = 1% max, $F = 1\text{kHz}$, $R_L = 16\Omega$, single-ended THD+N = 1% max, $F = 1\text{kHz}$, $R_L = 32\Omega$, phantom ground THD+N = 1% max, $F = 1\text{kHz}$, $R_L = 16\Omega$, phantom ground	60 95 60 95	88 158 85 150		mW
THD+N	Total harmonic distortion + noise ($A_v = -1$)	$R_L = 32\Omega$, $P_{out} = 60\text{mW}$, $20\text{Hz} \leq F \leq 20\text{kHz}$, single-ended $R_L = 16\Omega$, $P_{out} = 90\text{mW}$, $20\text{Hz} \leq F \leq 20\text{kHz}$, single-ended $R_L = 32\Omega$, $P_{out} = 60\text{mW}$, $20\text{Hz} \leq F \leq 20\text{kHz}$, phantom ground $R_L = 16\Omega$, $P_{out} = 90\text{mW}$, $20\text{Hz} \leq F \leq 20\text{kHz}$, phantom ground		0.3 0.3 0.3 0.3		%
PSRR	Power supply rejection ratio	Inputs grounded ⁽¹⁾ , $A_v = -1$, $R_L \geq 16\Omega$, $C_b = 1\mu\text{F}$, $F = 217\text{Hz}$, $V_{ripple} = 200\text{mVpp}$ Single-ended output referenced to phantom ground Single-ended output referenced to ground	66 61	72 67		dB
I_{out}	Max output current	THD +N $\leq 1\%$, $R_L = 16\Omega$ connected between out and $V_{CC}/2$		140		mA
V_O	Output swing	V_{OL} : $R_L = 32\Omega$ V_{OH} : $R_L = 32\Omega$ V_{OL} : $R_L = 16\Omega$ V_{OH} : $R_L = 16\Omega$	4.39 4.17	0.14 4.75 0.25 4.55	0.47 0.69	V
SNR	Signal-to-noise ratio	A-weighted, $A_v = -1$, $R_L = 32\Omega$, THD +N < 0.4%, $20\text{Hz} \leq F \leq 20\text{kHz}$ Single-ended Phantom ground		104 105		dB
Cross-talk	Channel separation	$R_L = 32\Omega$, $A_v = -1$, phantom ground $F = 1\text{kHz}$ $F = 20\text{Hz}$ to 20kHz $R_L = 32\Omega$, $A_v = -1$, single-ended $F = 1\text{kHz}$ $F = 20\text{Hz}$ to 20kHz		-73 -68 -110 -90		dB
V_{OO}	Output offset voltage	Phantom ground configuration, floating inputs, $R_{feed} = 22\text{K}\Omega$		5	20	mV
t_{WU}	Wake-up time	Phantom ground configuration Single-ended configuration		50 100	80 160	ms

1. Guaranteed by design and evaluation.

Table 5. Electrical characteristics at $V_{CC} = +3.0\text{ V}$ with $GND = 0\text{ V}$, $T_{amb} = 25^\circ\text{C}$ (unless otherwise specified) ⁽¹⁾

Symbol	Parameter	Test conditions	Min.	Typ.	Max.	Unit
I_{CC}	Supply current	No input signal, no load, single-ended No input signal, no load, phantom ground		2 2.8	2.8 4.2	mA
I_{STBY}	Standby current	No input signal, $R_L=32\Omega$		10	1000	nA
P_{out}	Output power	THD+N = 1% max, F = 1kHz, $R_L = 32\Omega$, single-ended THD+N = 1% max, F = 1kHz, $R_L = 16\Omega$, single-ended THD+N = 1% max, F = 1kHz, $R_L = 32\Omega$, phantom ground THD+N = 1% max, F = 1kHz, $R_L = 16\Omega$, phantom ground	20 30 20 30	31 52 31 54		mW
THD+N	Total harmonic distortion + noise ($A_v=-1$)	$R_L = 32\Omega$, $P_{out} = 25\text{mW}$, $20\text{Hz} \leq F \leq 20\text{kHz}$, single-ended $R_L = 16\Omega$, $P_{out} = 40\text{mW}$, $20\text{Hz} \leq F \leq 20\text{kHz}$, single-ended $R_L = 32\Omega$, $P_{out} = 25\text{mW}$, $20\text{Hz} \leq F \leq 20\text{kHz}$, phantom ground $R_L = 16\Omega$, $P_{out} = 40\text{mW}$, $20\text{Hz} \leq F \leq 20\text{kHz}$, phantom ground		0.3 0.3 0.3 0.3		%
PSRR	Power supply rejection ratio	Inputs grounded ⁽²⁾ , $A_v=-1$, $R_L \geq 16\Omega$, $C_b=1\mu\text{F}$, F = 217Hz, $V_{ripple} = 200\text{mVpp}$ Single-ended output referenced to phantom ground Single-ended output referenced to ground	64 59	70 65		dB
I_{out}	Max output current	THD +N $\leq 1\%$, $R_L = 16\Omega$ connected between out and $V_{CC}/2$		82		mA
V_O	Output swing	V_{OL} : $R_L = 32\Omega$ V_{OH} : $R_L = 32\Omega$ V_{OL} : $R_L = 16\Omega$ V_{OH} : $R_L = 16\Omega$	2.6 2.45	0.12 2.83 0.19 2.70	0.34 0.49	V
SNR	Signal-to-noise ratio	A-weighted, $A_v=-1$, $R_L = 32\Omega$, THD +N < 0.4%, $20\text{Hz} \leq F \leq 20\text{kHz}$ Single-ended Phantom ground		100 101		dB
Cross-talk	Channel separation	$R_L = 32\Omega$, $A_v=-1$, phantom ground F = 1kHz F = 20Hz to 20kHz $R_L = 32\Omega$, $A_v=-1$, single-ended F = 1kHz F = 20Hz to 20kHz		-73 -68 -110 -90		dB
V_{OO}	Output offset voltage	Phantom ground configuration, floating inputs, $R_{feed}=22\text{K}\Omega$		5	20	mV
t_{WU}	Wake-up time	Phantom ground configuration Single-ended configuration		50 100	80 160	ms

1. All electrical values are guaranteed with correlation measurements at 2.6 and 5 V.
2. Guaranteed by design and evaluation.

**Table 6. Electrical characteristics at $V_{CC} = +2.6\text{ V}$
with $GND = 0\text{ V}$, $T_{amb} = 25^\circ\text{C}$ (unless otherwise specified)**

Symbol	Parameter	Test conditions	Min.	Typ.	Max.	Unit
I_{CC}	Supply current	No input signal, no load, single-ended No input signal, no load, phantom ground		1.9 2.8	2.7 4	mA
I_{STBY}	Standby current	No input signal, $R_L=32\Omega$		10	1000	nA
P_{out}	Output power	THD+N = 1% max, F = 1kHz, $R_L = 32\Omega$, single-ended THD+N = 1% max, F = 1kHz, $R_L = 16\Omega$, single-ended THD+N = 1% max, F = 1kHz, $R_L = 32\Omega$, phantom ground THD+N = 1% max, F = 1kHz, $R_L = 16\Omega$, phantom ground	15 22 15 22	23 38 23 39		mW
THD+N	Total harmonic distortion + noise ($A_v=-1$)	$R_L = 32\Omega$, $P_{out} = 20\text{mW}$, $20\text{Hz} \leq F \leq 20\text{kHz}$, single-ended $R_L = 16\Omega$, $P_{out} = 30\text{mW}$, $20\text{Hz} \leq F \leq 20\text{kHz}$, single-ended $R_L = 32\Omega$, $P_{out} = 20\text{mW}$, $20\text{Hz} \leq F \leq 20\text{kHz}$, phantom ground $R_L = 16\Omega$, $P_{out} = 30\text{mW}$, $20\text{Hz} \leq F \leq 20\text{kHz}$, phantom ground		0.3 0.3 0.3 0.3		%
PSRR	Power supply rejection ratio	Inputs grounded ⁽¹⁾ , $A_v=-1$, $R_L \geq 16\Omega$, $C_b=1\mu\text{F}$, F = 217Hz, $V_{ripple} = 200\text{mVpp}$ Single-ended output referenced to phantom ground Single-ended output referenced to ground	64 59	70 65		dB
I_{out}	Max output current	THD +N $\leq 1\%$, $R_L = 16\Omega$ connected between out and $V_{CC}/2$		70		mA
V_O	Output swing	V_{OL} : $R_L = 32\Omega$ V_{OH} : $R_L = 32\Omega$ V_{OL} : $R_L = 16\Omega$ V_{OH} : $R_L = 16\Omega$	2.25 2.11	0.11 2.45 0.18 2.32	0.3 0.44	V
SNR	Signal-to-noise ratio	A weighted, $A_v=-1$, $R_L = 32\Omega$, THD +N < 0.4%, $20\text{Hz} \leq F \leq 20\text{kHz}$ Single-ended Phantom ground		99 100		dB
Cross-talk	Channel separation	$R_L = 32\Omega$, $A_v=-1$, phantom ground F = 1kHz F = 20Hz to 20kHz $R_L = 32\Omega$, $A_v=-1$, single-ended F = 1kHz F = 20Hz to 20kHz		-73 -68 -110 -90		dB
V_{OO}	Output offset voltage	Phantom ground configuration, floating inputs, $R_{feed}=22\text{k}\Omega$		5	20	mV
t_{WU}	Wake-up time	Phantom ground configuration Single-ended configuration		50 100	80 160	ms

1. Guaranteed by design and evaluation.

Figure 2. Open-loop frequency response, $R_L = 1\text{ M}\Omega$

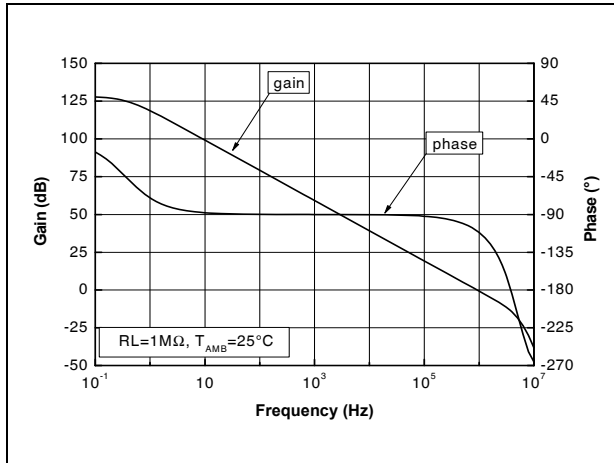

Figure 3. Open-loop frequency response, $R_L = 100\ \Omega, C_L = 400\text{ pF}$

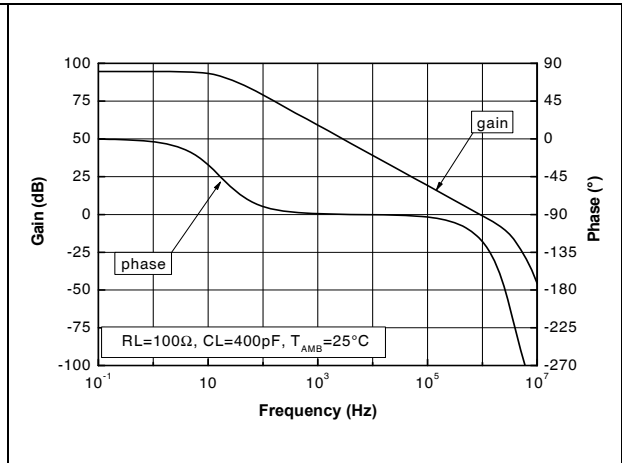

Figure 4. Open-loop frequency response, $R_L = 1\text{ M}\Omega, C_L = 100\text{ pF}$

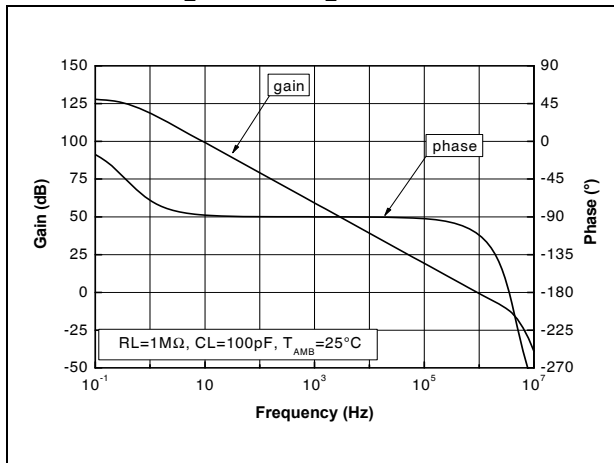

Figure 5. Open-loop frequency response, $R_L = 16\ \Omega$

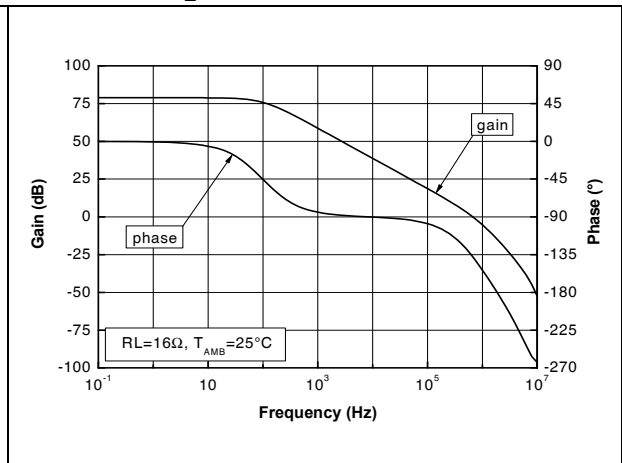

Figure 6. Open-loop frequency response, $R_L = 16\ \Omega, C_L = 400\text{ pF}$

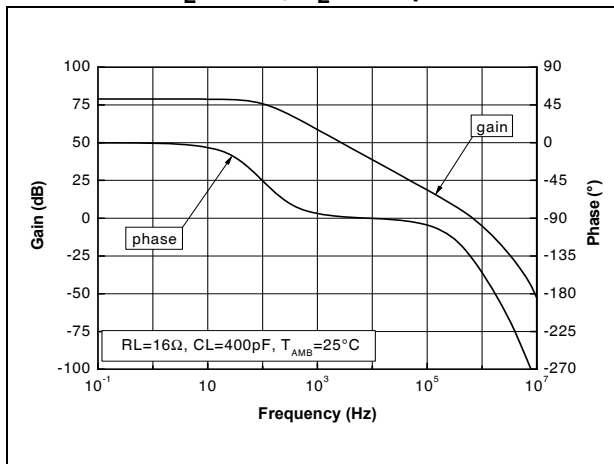

Figure 7. Output swing vs. power supply voltage

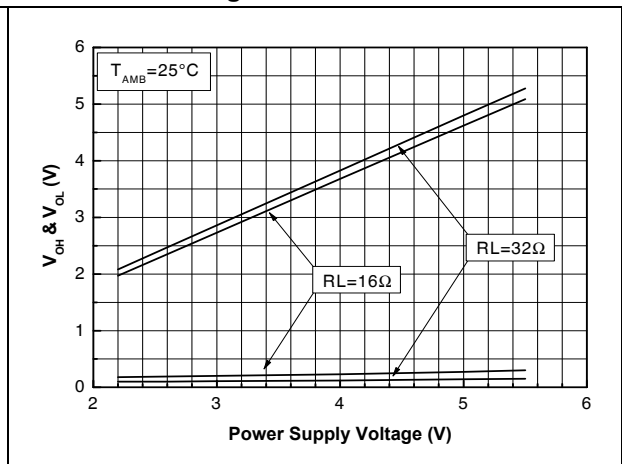

Figure 8. THD+N vs. output power, PHG, F = 1 kHz, $R_L = 16 \Omega$, $A_v = 1$

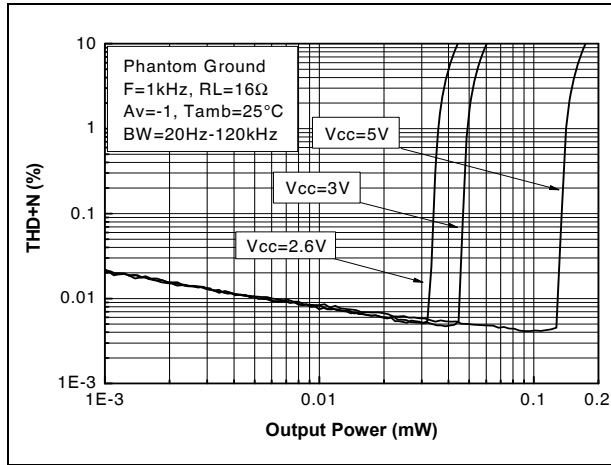

Figure 9. THD+N vs. output power, PHG, F = 20 kHz, $R_L = 16 \Omega$, $A_v = 1$

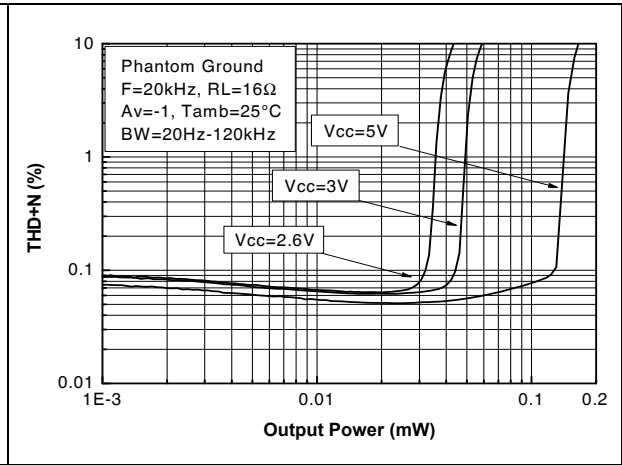

Figure 10. THD+N vs. output power, PHG, F = 1 kHz, $R_L = 32 \Omega$, $A_v = 1$

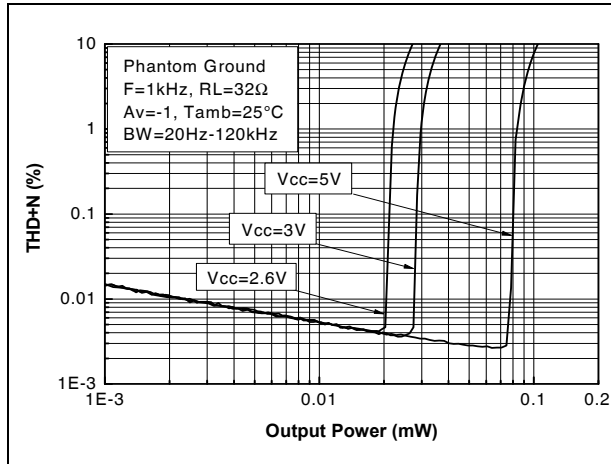

Figure 11. THD+N vs. output power, PHG, F = 20 kHz, $R_L = 32 \Omega$, $A_v = 1$

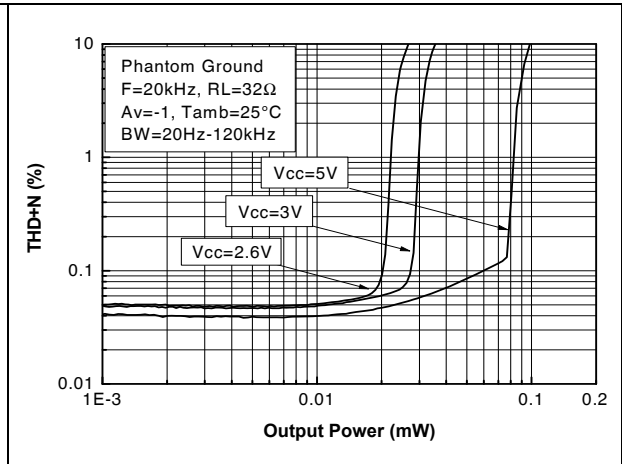

Figure 12. THD+N vs. output power, SE, F = 1 kHz, $R_L = 16 \Omega$, $A_v = 1$

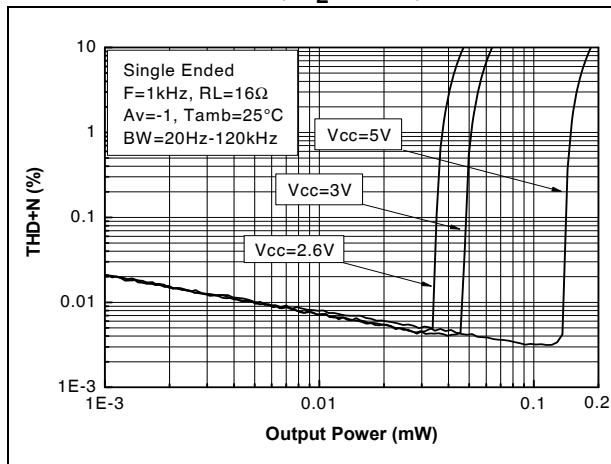

Figure 13. THD+N vs. output power, SE, F = 20 kHz, $R_L = 16 \Omega$, $A_v = 1$

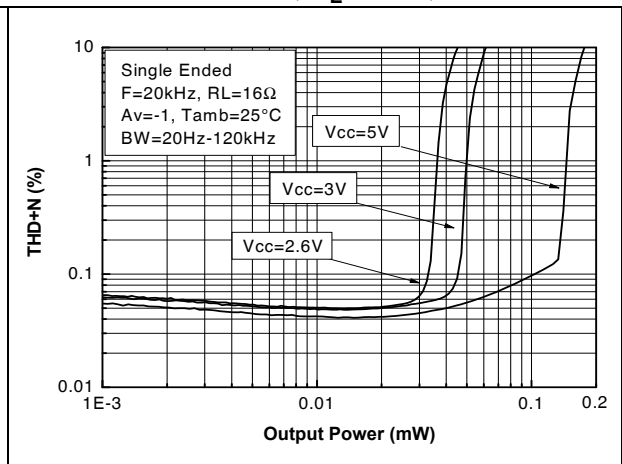

Figure 14. THD+N vs. output power, SE, F = 1 kHz, $R_L = 32 \Omega$, $A_v = 1$

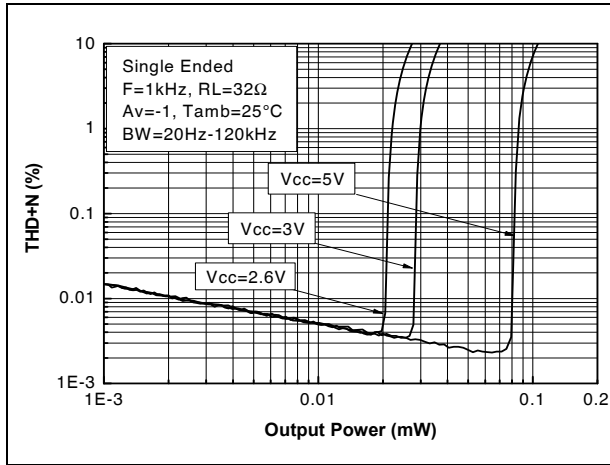

Figure 15. THD+N vs. output power, SE, F = 20 kHz, $R_L = 32 \Omega$, $A_v = 1$

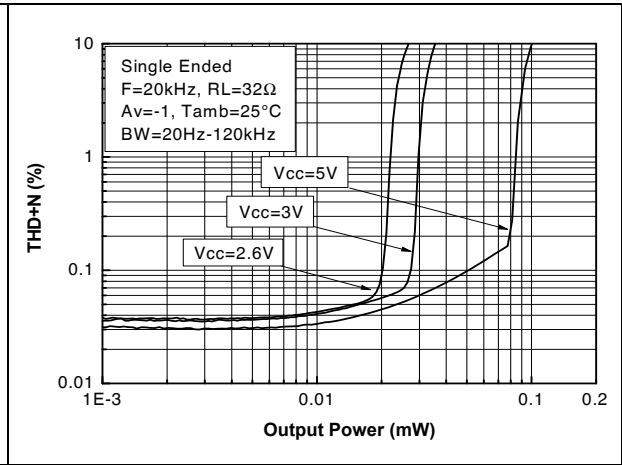

Figure 16. THD+N vs. output power, PHG, F = 1 kHz, $R_L = 16 \Omega$, $A_v = 4$

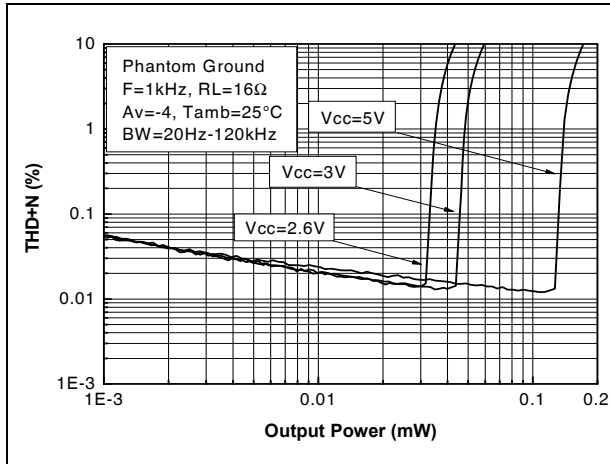

Figure 17. THD+N vs. output power, PHG, F = 20 kHz, $R_L = 16 \Omega$, $A_v = 4$

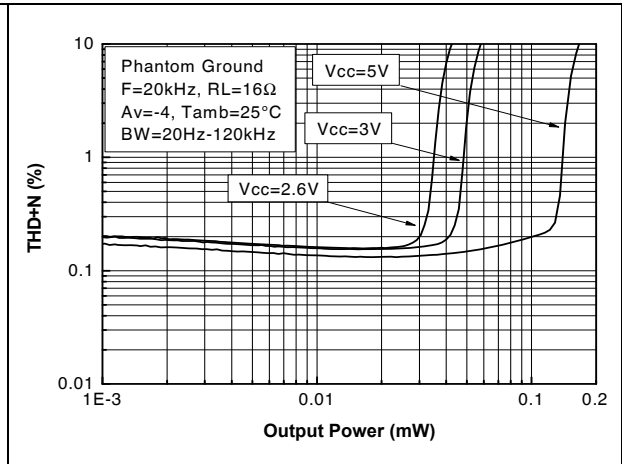

Figure 18. THD+N vs. output power, PHG, F = 1 kHz, $R_L = 32 \Omega$, $A_v = 4$

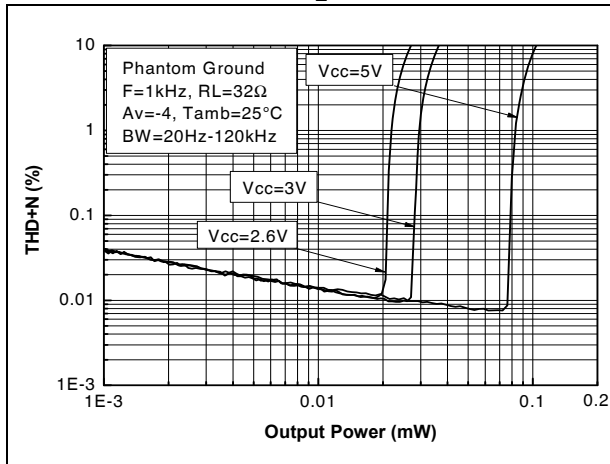

Figure 19. THD+N vs. output power, PHG, F = 20 kHz, $R_L = 32 \Omega$, $A_v = 4$

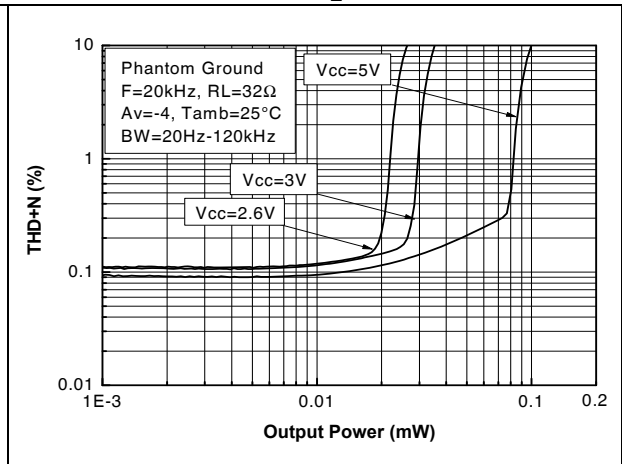

Figure 20. THD+N vs. output power, SE,
 $F = 1 \text{ kHz}$, $R_L = 16 \Omega$, $A_v = 4$

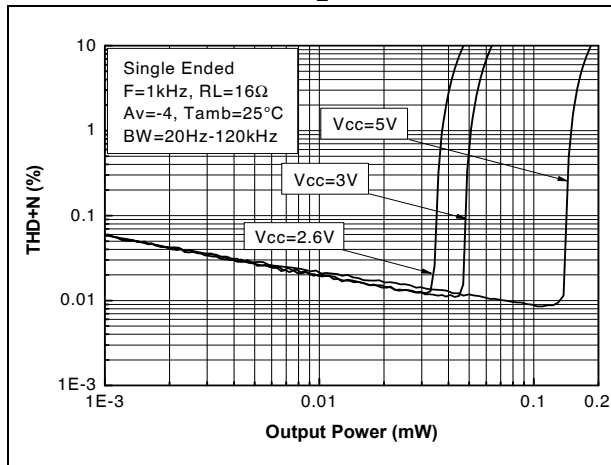

Figure 21. THD+N vs. output power, SE,
 $F = 20 \text{ kHz}$, $R_L = 16 \Omega$, $A_v = 4$

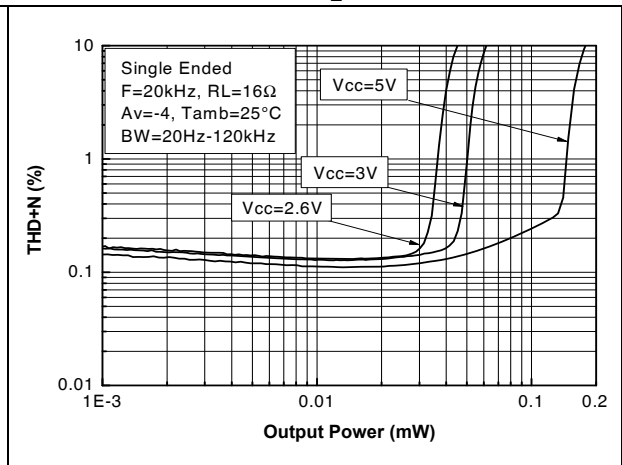

Figure 22. THD+N vs. output power, SE,
 $F = 1 \text{ kHz}$, $R_L = 32 \Omega$, $A_v = 4$

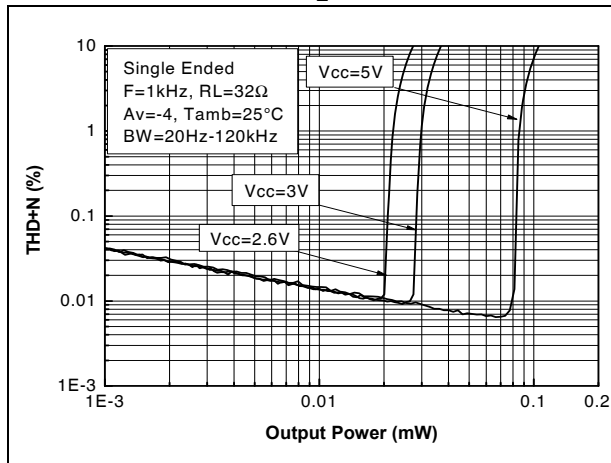

Figure 23. THD+N vs. output power, SE,
 $F = 20 \text{ kHz}$, $R_L = 32 \Omega$, $A_v = 4$

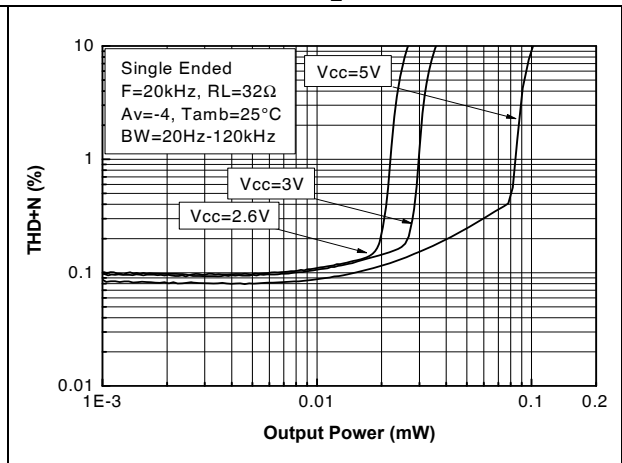

Figure 24. THD+N vs. frequency, PHG,
 $R_L = 16 \Omega$, $A_v = 1$

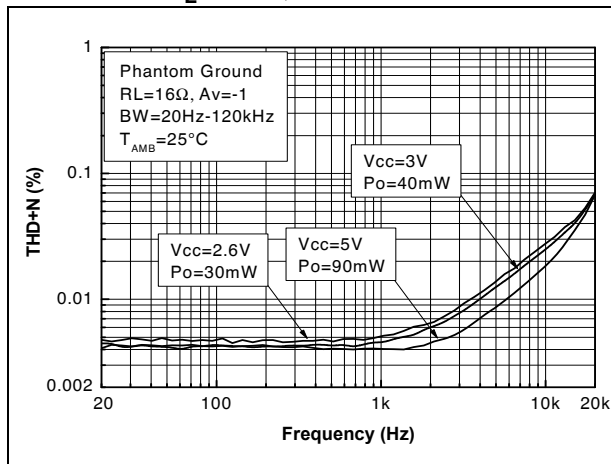

Figure 25. THD+N vs. frequency, PHG,
 $R_L = 32 \Omega$, $A_v = 1$

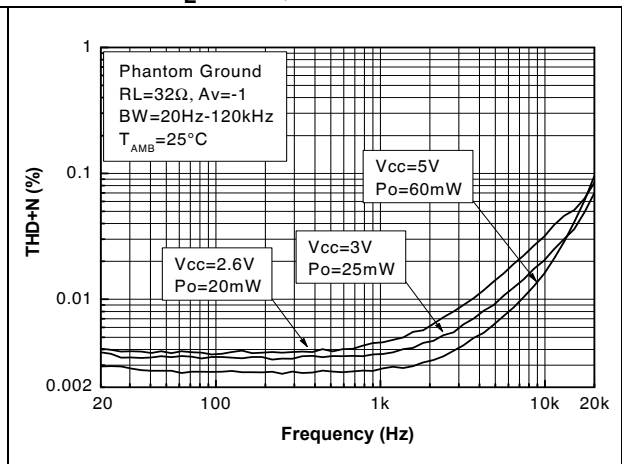

Figure 26. THD+N vs. frequency, SE,
 $R_L = 16 \Omega$, $A_v = 1$

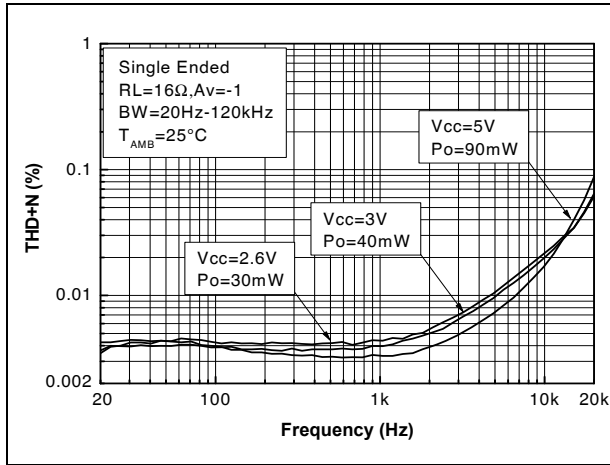

Figure 27. THD+N vs. frequency, SE,
 $R_L = 32 \Omega$, $A_v = 1$

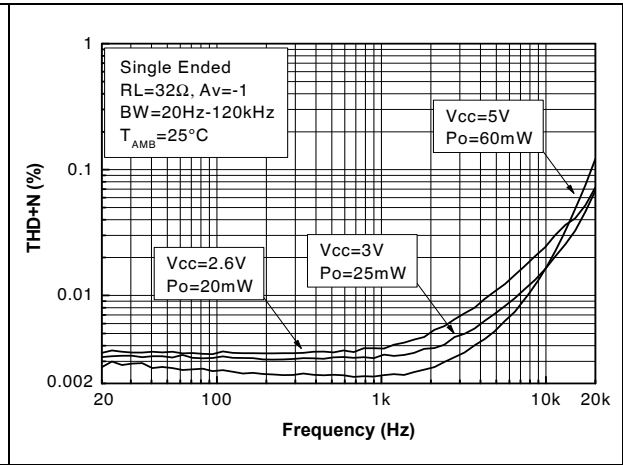

Figure 28. THD+N vs. frequency, PHG,
 $R_L = 16 \Omega$, $A_v = 4$

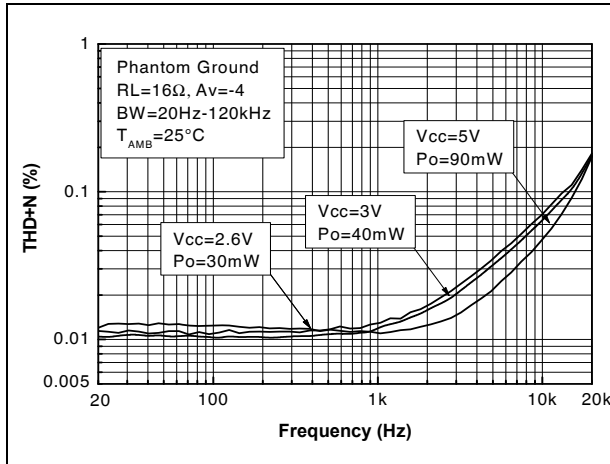

Figure 29. THD+N vs. frequency, PHG,
 $R_L = 32 \Omega$, $A_v = 4$

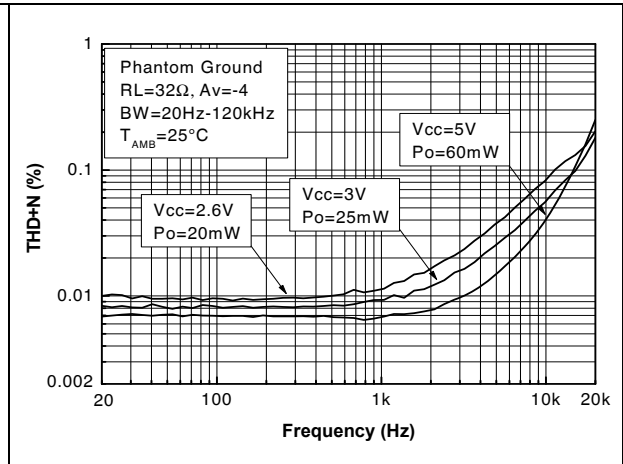

Figure 30. THD+N vs. frequency, SE,
 $R_L = 16 \Omega$, $A_v = 4$

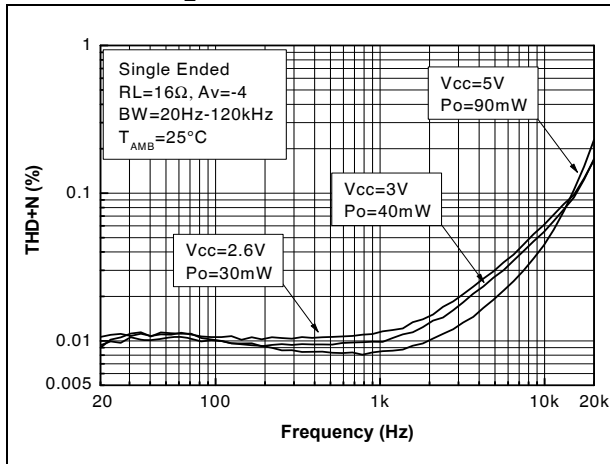

Figure 31. THD+N vs. frequency, SE,
 $R_L = 32 \Omega$, $A_v = 4$

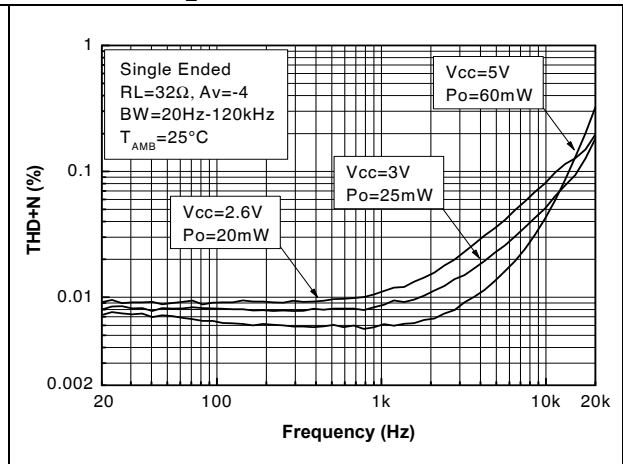

Figure 32. Output power vs. power supply voltage, PHG, $R_L = 16 \Omega$, $F = 1 \text{ kHz}$

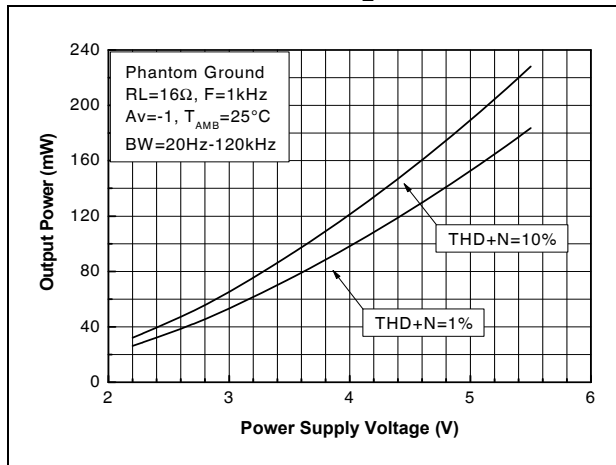

Figure 33. Output power vs. power supply voltage, PHG, $R_L = 32 \Omega$, $F = 1 \text{ kHz}$

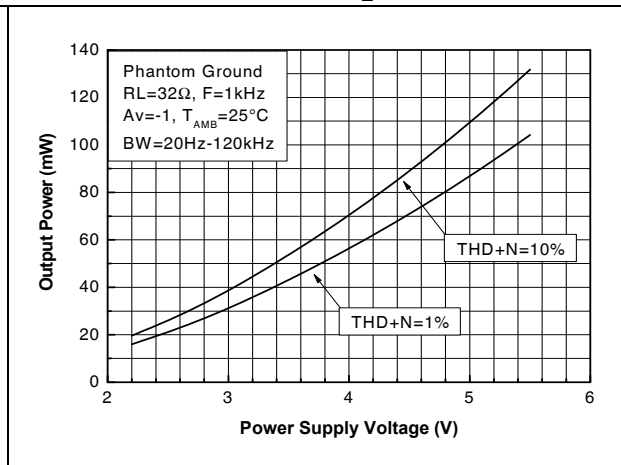

Figure 34. Output power vs. power supply voltage, SE, $R_L = 16 \Omega$, $F = 1 \text{ kHz}$

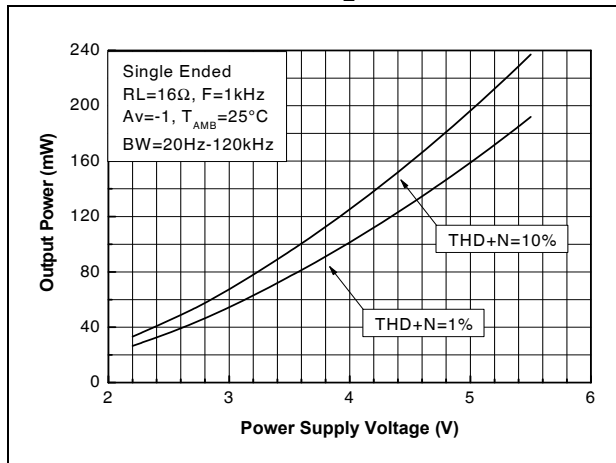

Figure 35. Output power vs. power supply voltage, SE, $R_L = 32 \Omega$, $F = 1 \text{ kHz}$

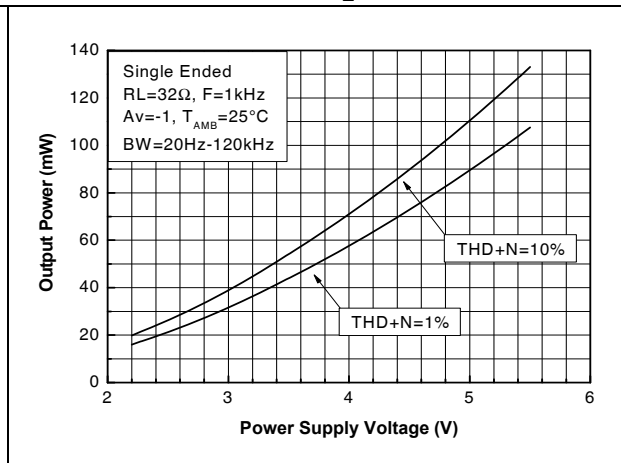

Figure 36. Output power vs. load resistance, PHG, $V_{CC} = 2.6 \text{ V}$

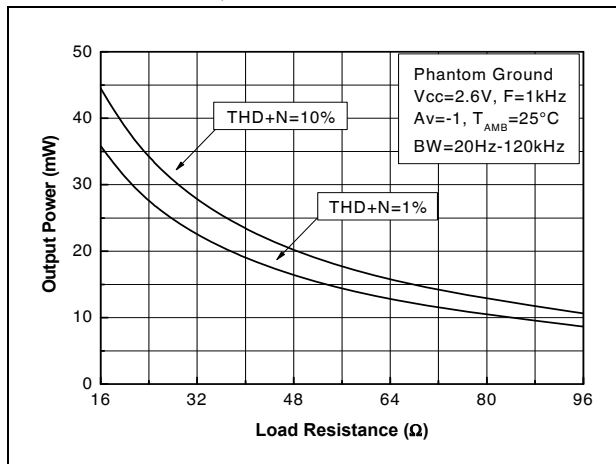

Figure 37. Output power vs. load resistance, SE, $V_{CC} = 2.6 \text{ V}$

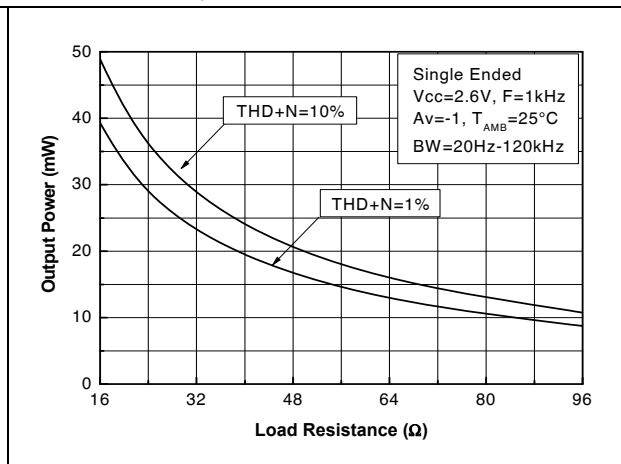

Figure 38. Output power vs. load resistance, PHG, Vcc = 3 V

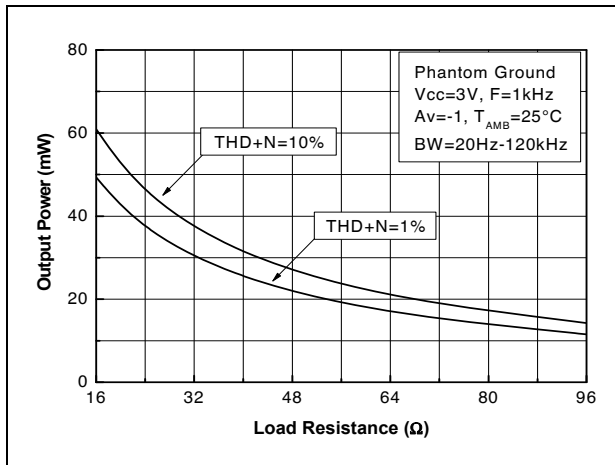

Figure 39. Output power vs. load resistance, SE, Vcc = 3 V

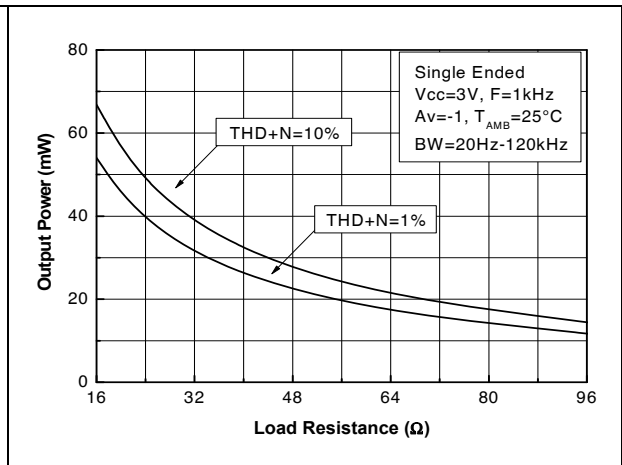

Figure 40. Output power vs. load resistance, PHG, Vcc = 5 V

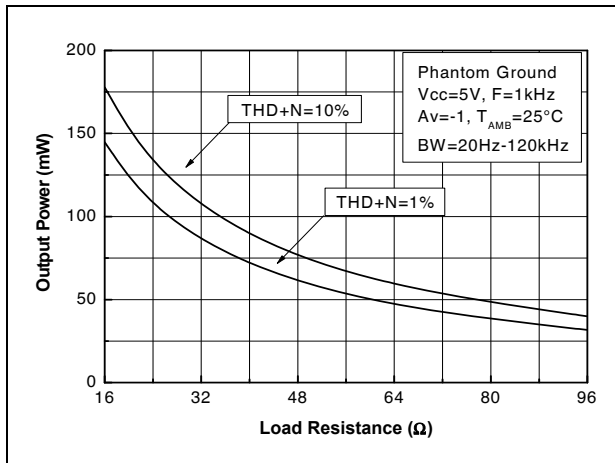

Figure 41. Output power vs. load resistance, SE, Vcc = 5 V

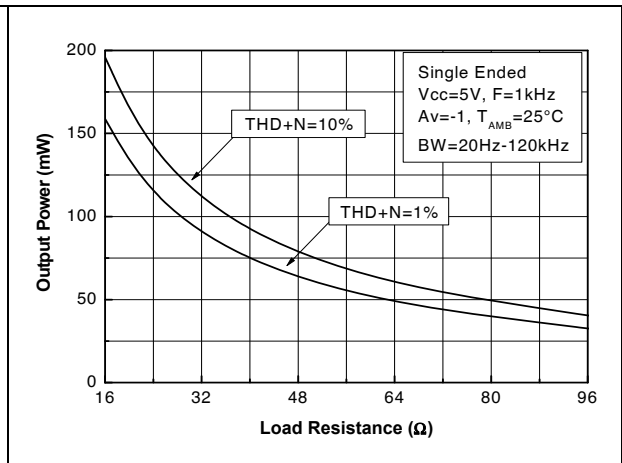

Figure 42. Power dissipation vs. output power, PHG, Vcc = 2.6 V

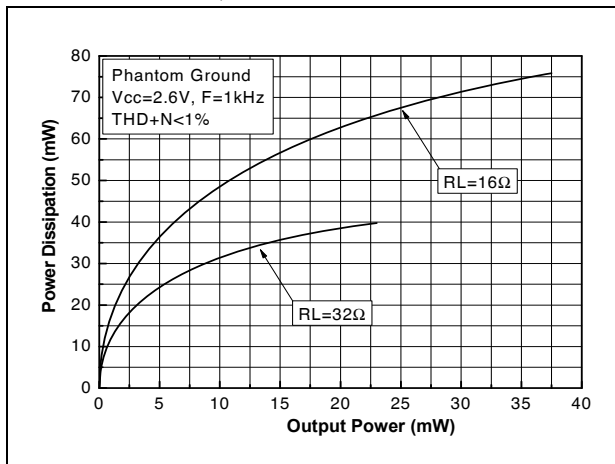

Figure 43. Power dissipation vs. output power, SE, Vcc = 2.6 V

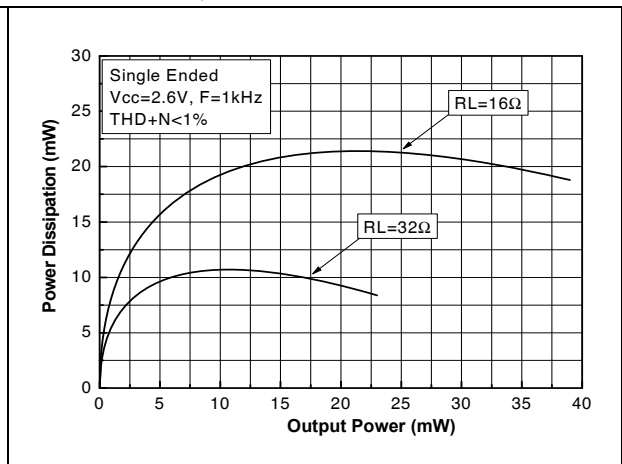

Figure 44. Power dissipation vs. output power, Figure 45. Power dissipation vs. output power, PHG, $V_{CC} = 3\text{ V}$

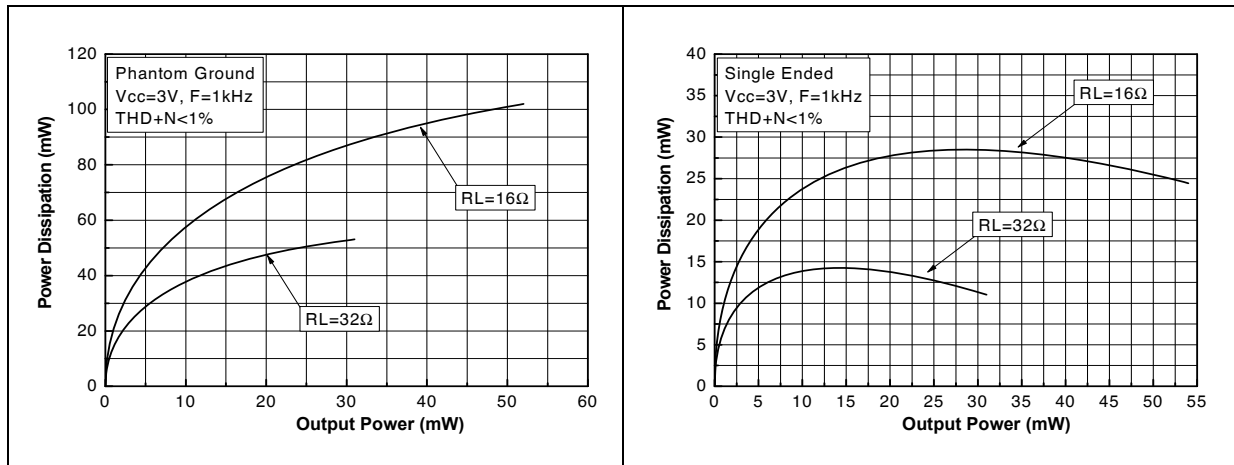

Figure 46. Power dissipation vs. output power, Figure 47. Power dissipation vs. output power, PHG, $V_{CC} = 5\text{ V}$

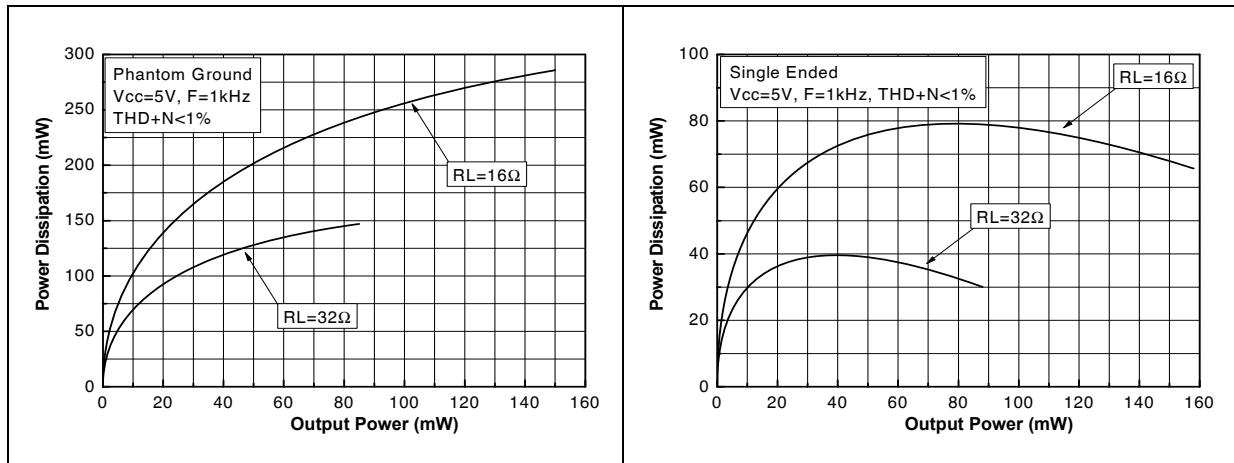

Figure 48. Crosstalk vs. frequency, SE, $V_{CC} = 5\text{ V}$, $R_L = 16\ \Omega$, $A_v = 1$

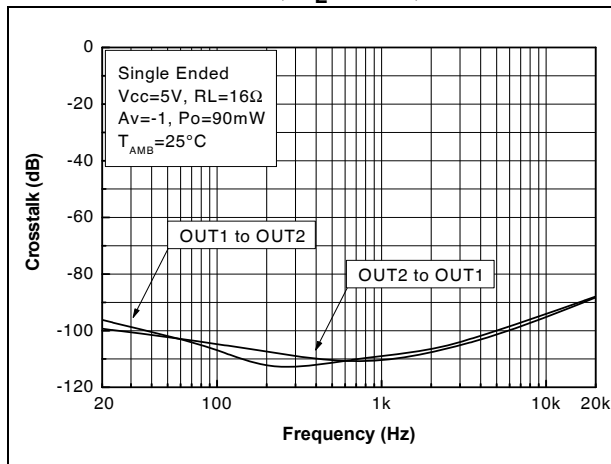

Figure 49. Crosstalk vs. frequency, SE, $V_{CC} = 5\text{ V}$, $R_L = 32\ \Omega$, $A_v = 1$

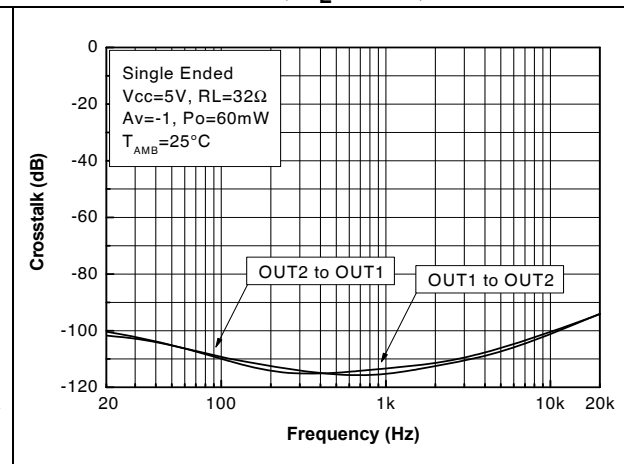

Figure 50. Crosstalk vs. frequency, SE, $V_{CC} = 5\text{ V}$, $R_L = 16\ \Omega$, $A_v = 4$

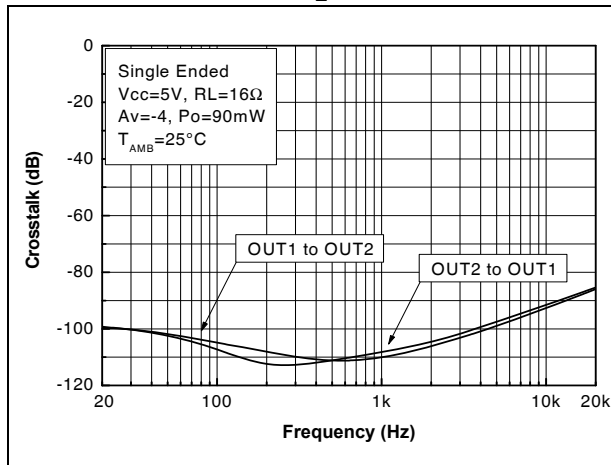

Figure 51. Crosstalk vs. frequency, SE, $V_{CC} = 5\text{ V}$, $R_L = 32\ \Omega$, $A_v = 4$

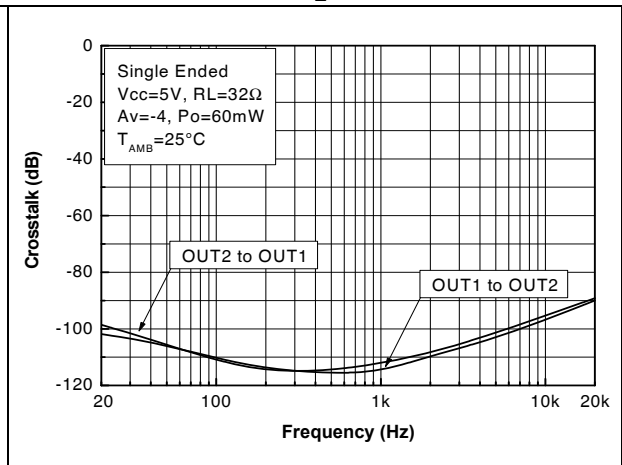

Figure 52. Crosstalk vs. frequency, PHG, $V_{CC} = 5\text{ V}$, $A_v = 1$

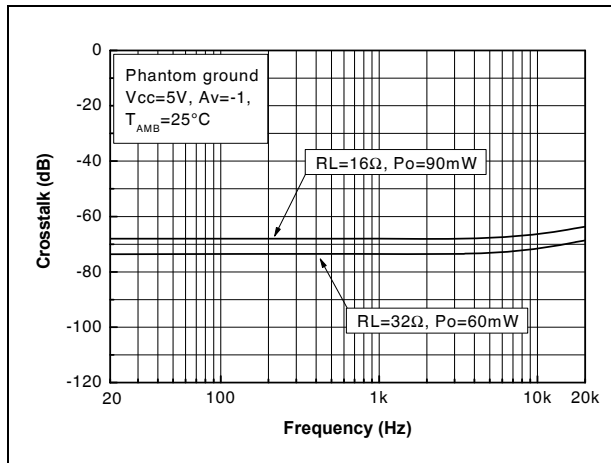

Figure 53. Crosstalk vs. frequency, PHG, $V_{CC} = 5\text{ V}$, $A_v = 4$

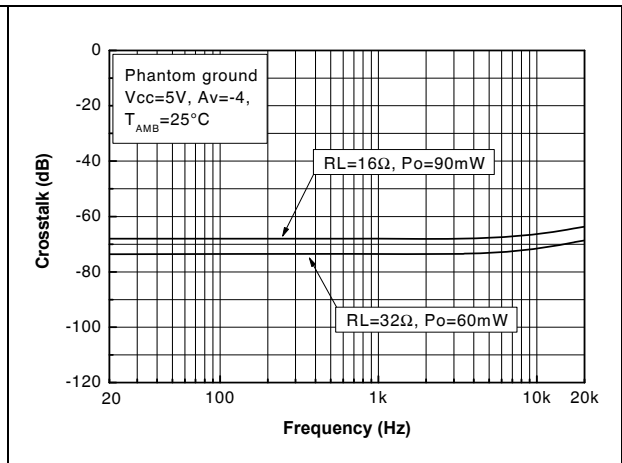

Figure 54. SNR vs. power supply voltage, PHG, unweighted, $A_v = 1$

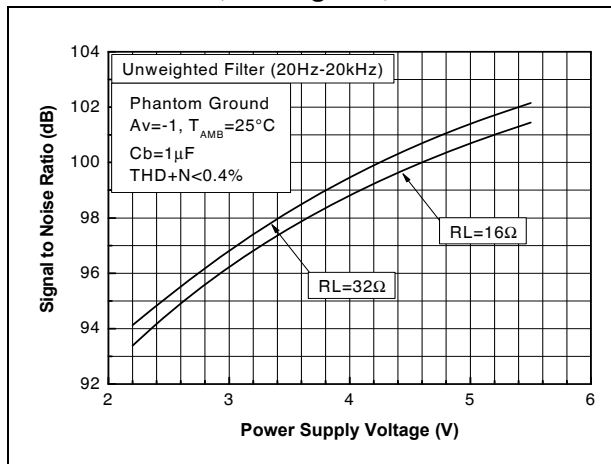

Figure 55. SNR vs. power supply voltage, SE, unweighted, $A_v = 1$

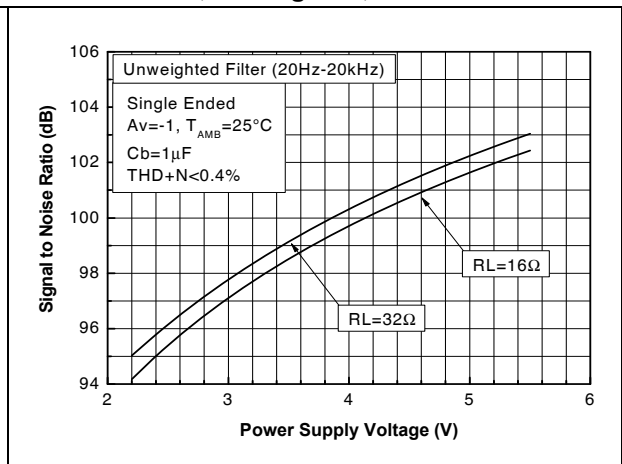

Figure 56. SNR vs. power supply voltage, PHG, A-weighted, Av = 1

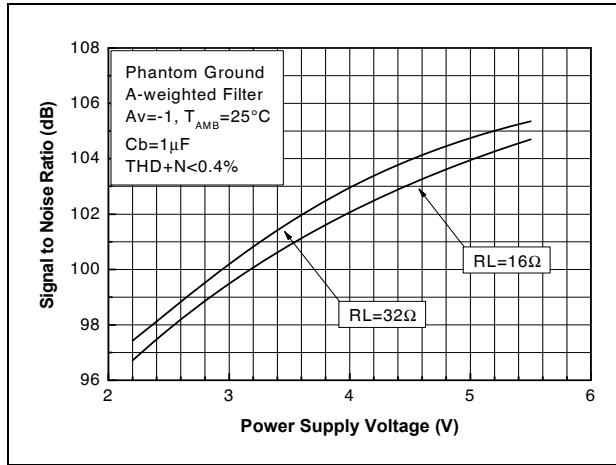

Figure 57. SNR vs. power supply voltage, SE, A-weighted, Av = 1

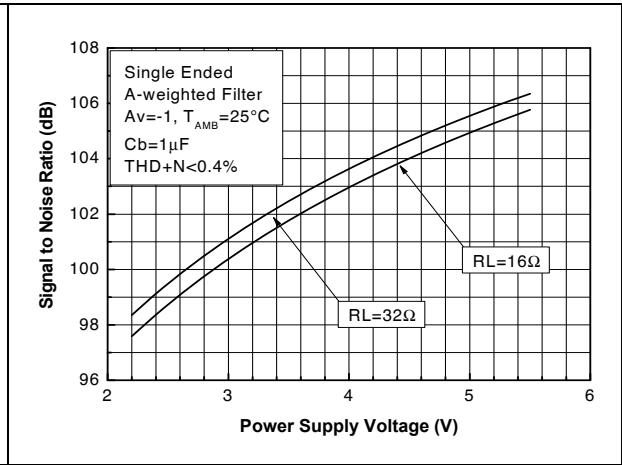

Figure 58. SNR vs. power supply voltage, PHG, unweighted, Av = 4

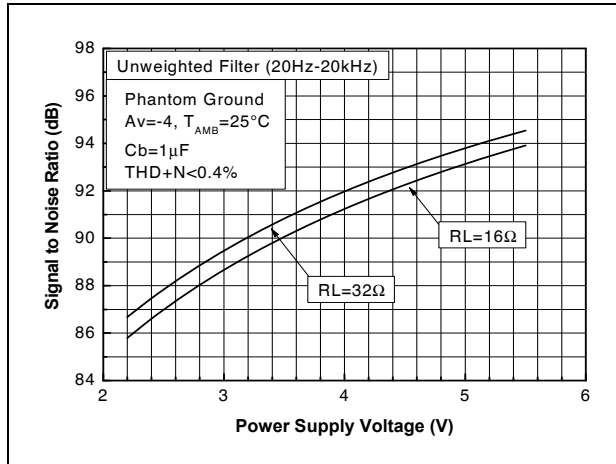

Figure 59. SNR vs. power supply voltage, SE, unweighted, Av = 4

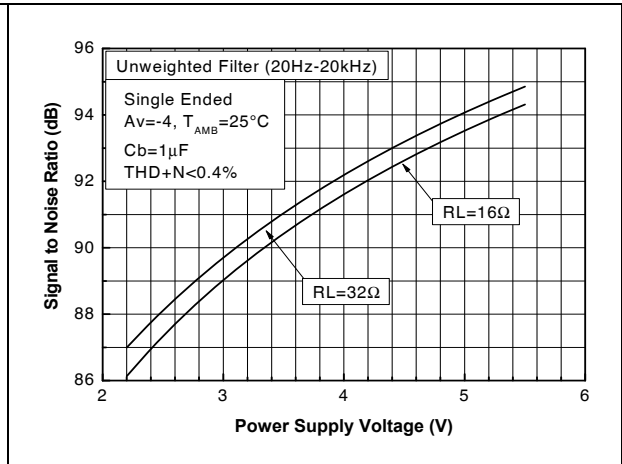

Figure 60. SNR vs. power supply voltage, PHG, A-weighted, Av = 4

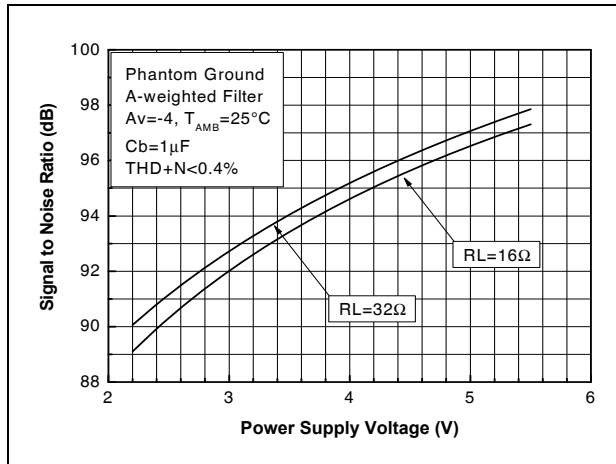

Figure 61. SNR vs. power supply voltage, SE, A-weighted, Av = 4

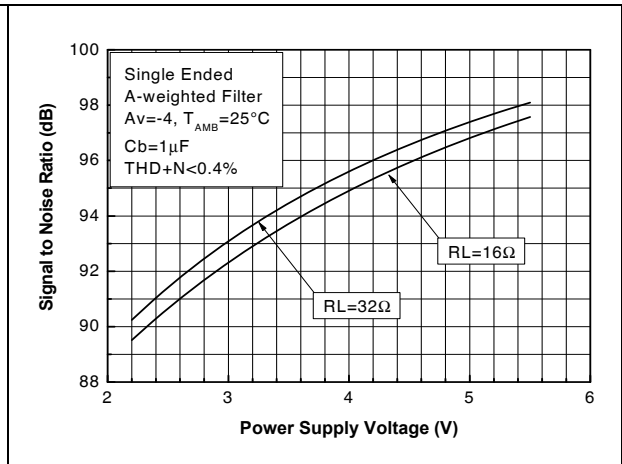

Figure 62. Power supply rejection ratio vs. frequency vs. Vcc, PHG

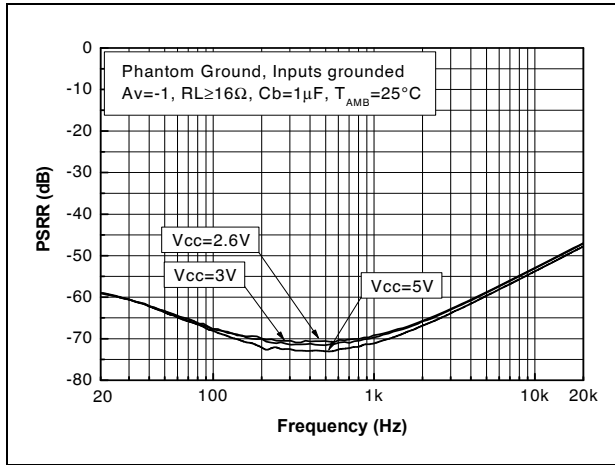

Figure 63. Power supply rejection ratio vs. frequency vs. Vcc, SE

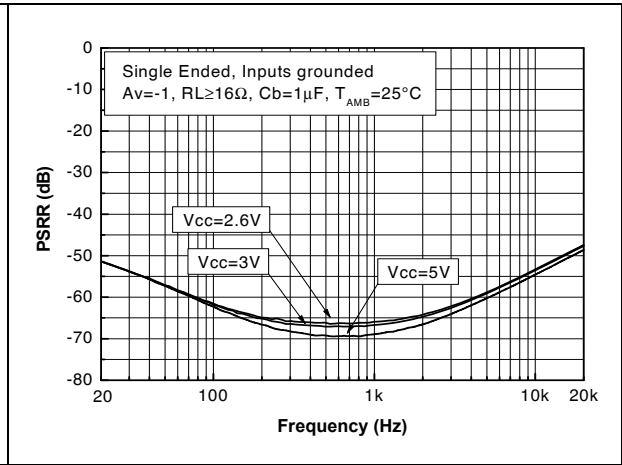

Figure 64. Power supply rejection ratio vs. frequency vs. gain, PHG

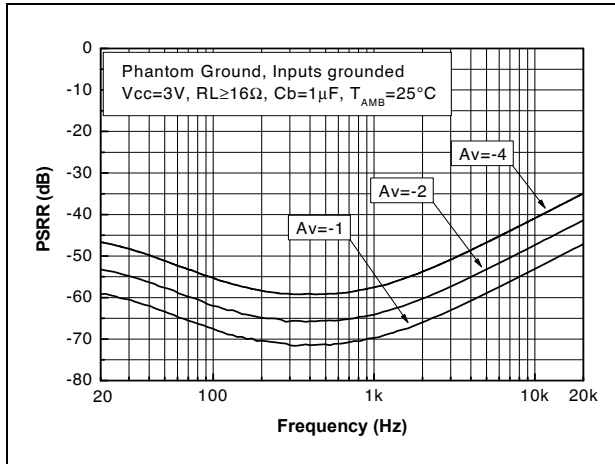

Figure 65. Power supply rejection ratio vs. frequency vs. gain, SE

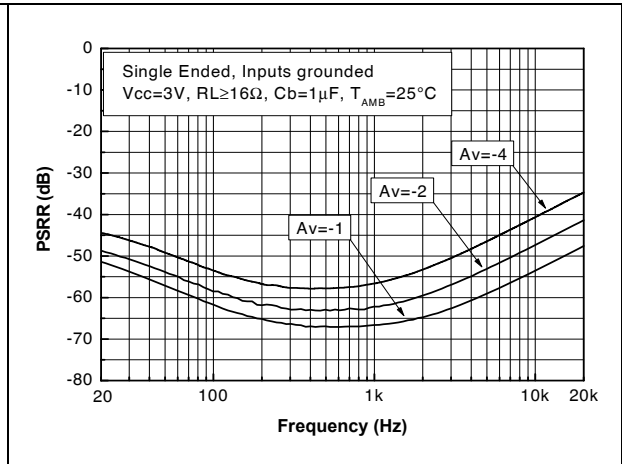

Figure 66. PSRR vs. frequency vs. bypass capacitor, PHG

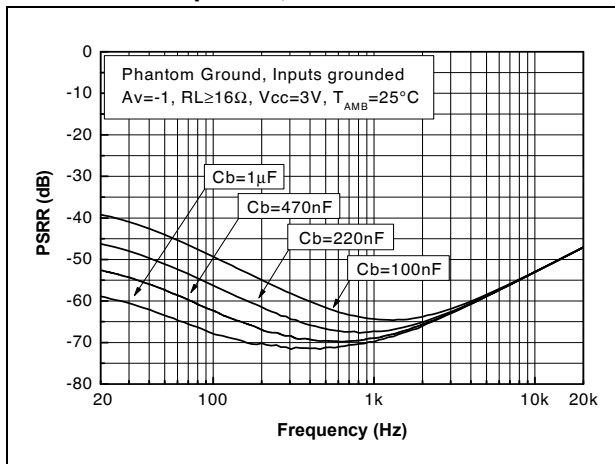

Figure 67. PSRR vs. frequency vs. bypass capacitor, SE

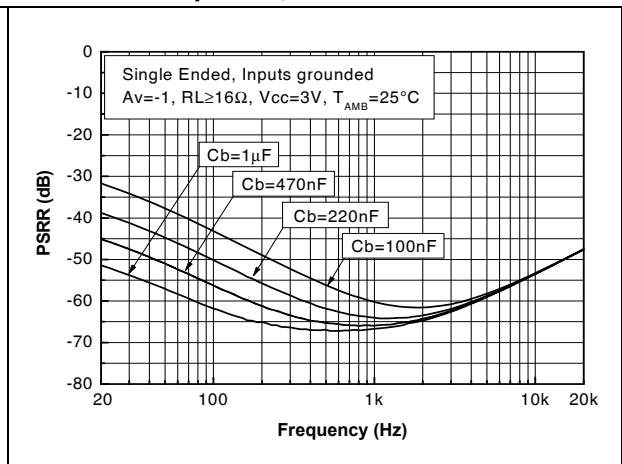

Figure 68. Current consumption vs. power supply voltage, PHG

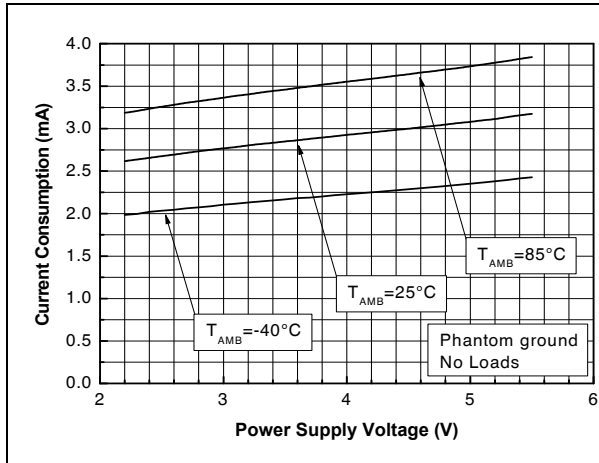

Figure 69. Current consumption vs. power supply voltage, SE

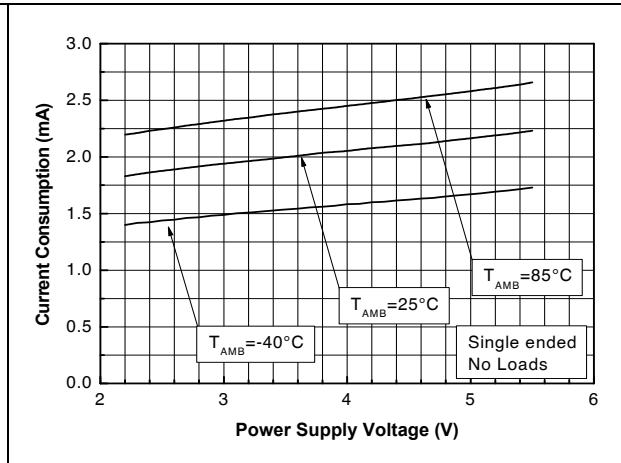

Figure 70. Current consumption vs. standby voltage, V_{CC} = 2.6 V, PHG

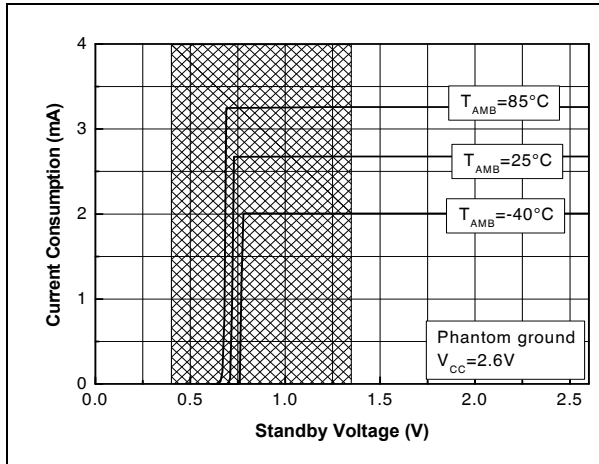

Figure 71. Current consumption vs. standby voltage, V_{CC} = 2.6 V, SE

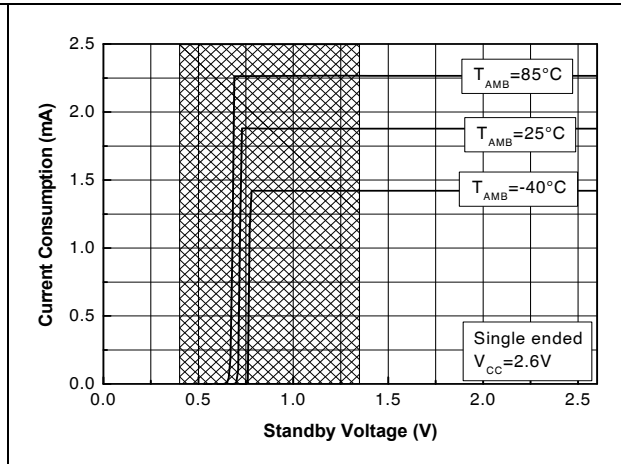

Figure 72. Current consumption vs. standby voltage, V_{CC} = 3 V, PHG

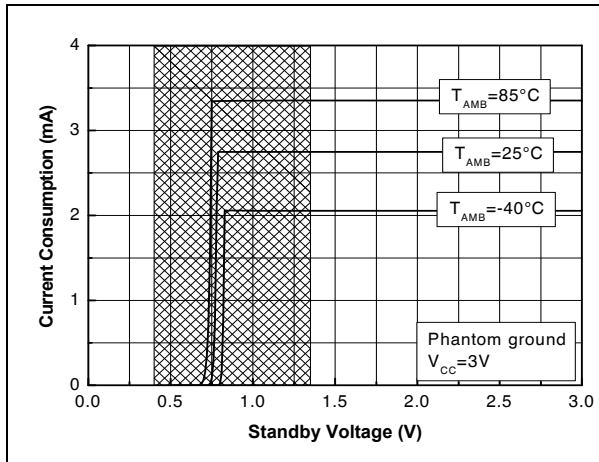

Figure 73. Current consumption vs. standby voltage, V_{CC} = 3 V, SE

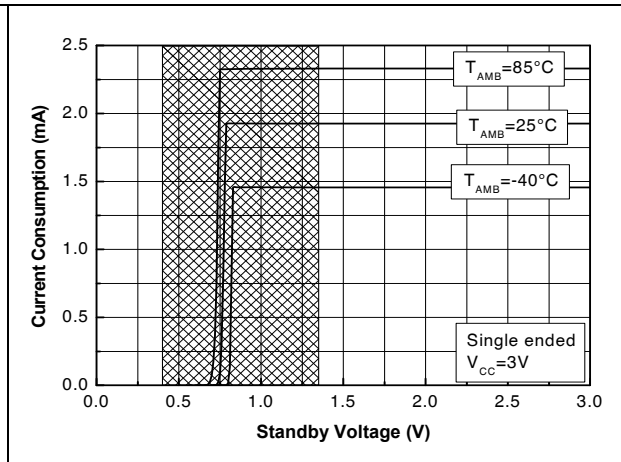

Figure 74. Current consumption vs. standby voltage, $V_{CC} = 5\text{ V}$, PHG

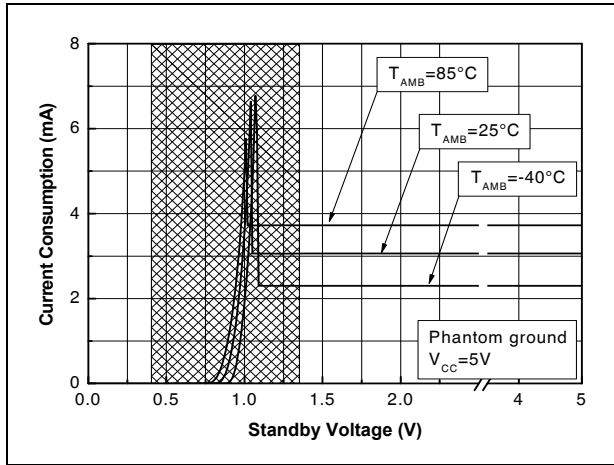

Figure 75. Current consumption vs. standby voltage, $V_{CC} = 5\text{ V}$, SE

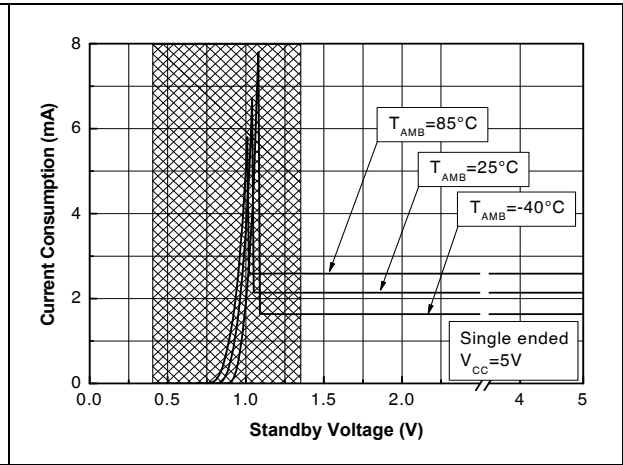
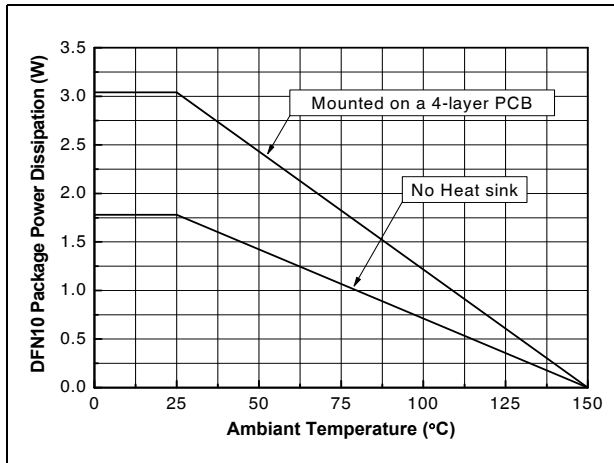

Figure 76. Power derating curves



4 Application information

4.1 General description

The TS4909 integrates two monolithic power amplifiers. The amplifier output can be configured to provide either single-ended (SE) capacitively-coupled output or phantom ground (PHG) capacitor-less output. [Figure 1: Typical applications for the TS4909 on page 5](#) shows schematics for each of these configurations.

Single-ended configuration

In the single-ended configuration, an output coupling capacitor, C_{out} , on the output of the power amplifier (V_{out1} and V_{out2}) is mandatory. The output of the power amplifier is biased to a DC voltage equal to $V_{CC}/2$ and the output coupling capacitor blocks this reference voltage.

Phantom ground configuration

In the phantom ground configuration, an internal buffer (V_{out3}) maintains the $V_{CC}/2$ voltage and the output of the power amplifiers are also biased to the $V_{CC}/2$ voltage. Therefore, no output coupling capacitors are needed. This is of primary importance in portable applications where space constraints are continually present.

4.2 Frequency response

Higher cut-off frequency

In the high frequency region, you can limit the bandwidth by adding a capacitor C_{feed} in parallel with R_{feed} . It forms a low-pass filter with a -3 dB cut-off frequency F_{CH} . Assuming that F_{CH} is the highest frequency to be amplified (with a 3 dB attenuation), the maximum value of C_{feed} is:

$$F_{CH} = \frac{1}{2\pi \cdot R_{feed} \cdot C_{feed}}$$

Figure 77. Higher cut-off frequency vs. feedback capacitor

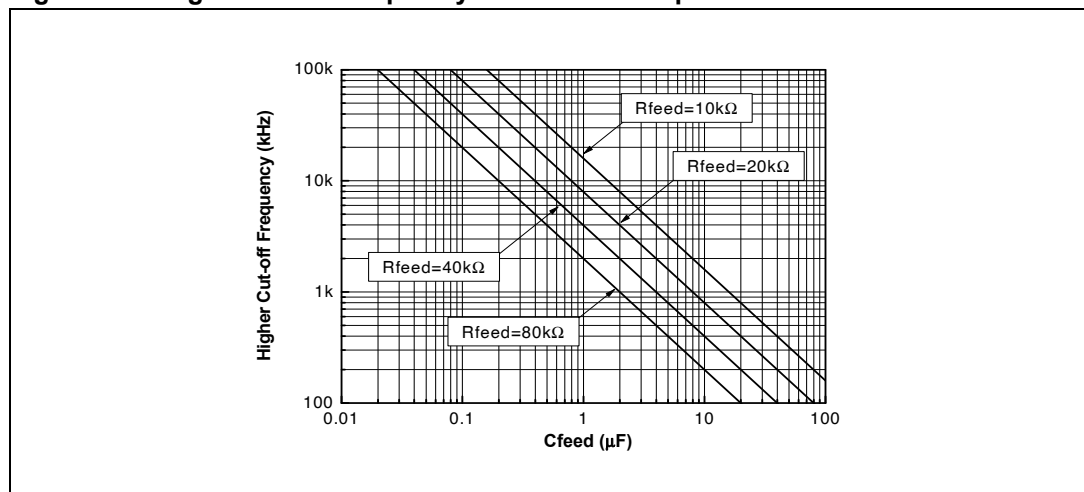

Lower cut-off frequency

The lower cut-off frequency F_{CL} of the TS4909 depends on input capacitors $C_{in1,2}$. In the single-ended configuration, F_{CL} depends on output capacitors $C_{out1,2}$ as well.

The input capacitor C_{in} in series with the input resistor R_{in} of the amplifier is equivalent to a first-order high-pass filter. Assuming that F_{CL} is the lowest frequency to be amplified (with a 3 dB attenuation), the minimum value of C_{in} is:

$$C_{in} = \frac{1}{2\pi \cdot F_{CL} \cdot R_{in}}$$

In the single-ended configuration, the capacitor C_{out} in series with the load resistor R_L is equivalent to a first-order high-pass filter. Assuming that F_{CL} is the lowest frequency to be amplified (with a 3 dB attenuation), the minimum value of C_{out} is:

$$C_{out} = \frac{1}{2\pi \cdot F_{CL} \cdot R_L}$$

Figure 78. Lower cut-off frequency vs. input capacitor

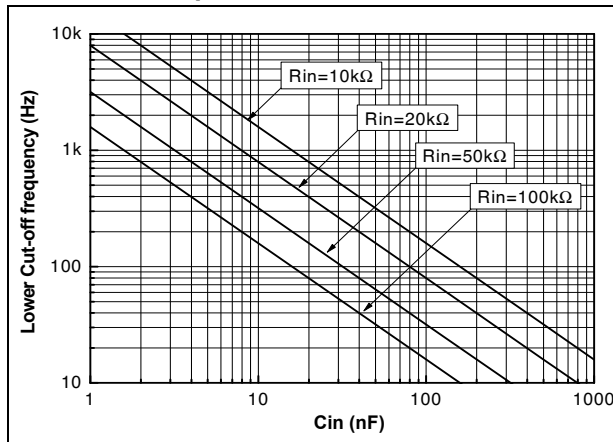
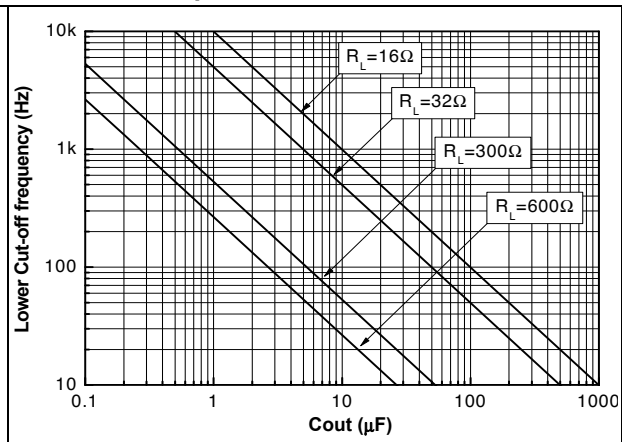

Figure 79. Lower cut-off frequency vs. output capacitor



Note: If F_{CL} is kept the same for calculation purposes, it must be taken into account that the 1st-order high-pass filter on the input and the 1st-order high-pass filter on the output create a 2nd-order high-pass filter in the audio signal path with an attenuation of 6 dB on F_{CL} and a roll-off of 40 db/decade.

4.3 Gain using the typical application schematics

In the flat region (no C_{in} effect), the output voltage of a channel is:

$$V_{OUT} = V_{IN} \cdot \left(\frac{R_{feed}}{R_{in}} \right) = V_{IN} \cdot A_V$$

The gain A_V is:

$$A_V = \frac{R_{feed}}{R_{in}}$$

Note: The configuration (either single-ended or phantom ground) has no effect on the value of the gain.

4.4 Power dissipation and efficiency

Hypotheses

- Voltage and current (V_{out} and I_{out}) in the load are sinusoidal.
- The supply voltage (V_{CC}) is a pure DC source.

Regarding the load we have:

$$V_{OUT} = V_{PEAK} \sin \omega t (V)$$

and

$$I_{OUT} = \frac{V_{OUT}}{R_L} (A)$$

and

$$P_{OUT} = \frac{V_{PEAK}^2}{2R_L} (A)$$

4.4.1 Single-ended configuration

The average current delivered by the power supply voltage is:

$$I_{CC_{AVG}} = \frac{1}{2\pi} \int_0^{\pi} \frac{V_{PEAK}}{R_L} \sin(t) dt = \frac{V_{PEAK}}{\pi R_L} (A)$$

Figure 80. Current delivered by power supply voltage in single-ended configuration

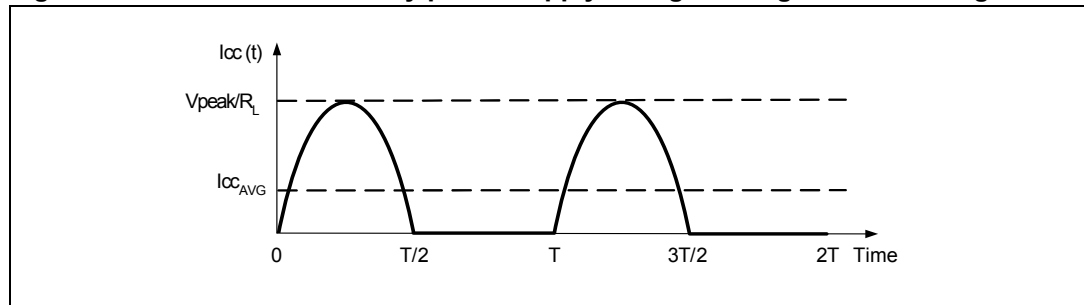

The power delivered by the power supply voltage is:

$$P_{supply} = V_{CC} I_{CC_{AVG}} (W)$$

Therefore, the power dissipation by each power amplifier is:

$$P_{diss} = P_{supply} - P_{OUT} (W)$$

$$P_{diss} = \frac{\sqrt{2} V_{CC}}{\pi \sqrt{R_L}} \sqrt{P_{OUT}} - P_{OUT} (W)$$

and the maximum value is obtained when:

$$\frac{\partial P_{diss}}{\partial P_{OUT}} = 0$$

and its value is:

$$P_{dissMAX} = \frac{V_{CC}^2}{\pi^2 R_L} (W)$$

Note: This maximum value depends only on the power supply voltage and load values.

The **efficiency** is the ratio between the output power and the power supply.

$$\eta = \frac{P_{OUT}}{P_{supply}} = \frac{\pi V_{PEAK}}{2V_{CC}}$$

The **maximum theoretical value** is reached when $V_{PEAK} = V_{CC}/2$, so:

$$\eta = \frac{\pi}{4} = 78.5\%$$

4.4.2 Phantom ground configuration

The average current delivered by the power supply voltage is:

$$I_{CC_{AVG}} = \frac{1}{\pi} \int_0^{\pi} \frac{V_{PEAK}}{R_L} \sin(t) dt = \frac{2V_{PEAK}}{\pi R_L} (A)$$

Figure 81. Current delivered by power supply voltage in phantom ground configuration

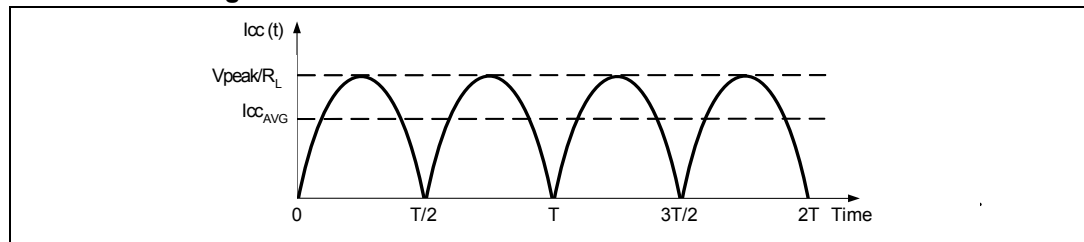

The power delivered by the power supply voltage is:

$$P_{supply} = V_{CC} I_{CC_{AVG}} (W)$$

Therefore, the power dissipation by each amplifier is:

$$P_{diss} = \frac{2\sqrt{2}V_{CC}}{\pi\sqrt{R_L}} \sqrt{P_{OUT}} - P_{OUT} (W)$$

and the maximum value is obtained when:

$$\frac{\partial P_{diss}}{\partial P_{OUT}} = 0$$

and its value is:

$$P_{dissMAX} = \frac{2V_{CC}^2}{\pi^2 R_L} (W)$$

Note: This maximum value depends only on the power supply voltage and load values.

The **efficiency** is the ratio between the output power and the power supply.

$$\eta = \frac{P_{\text{OUT}}}{P_{\text{supply}}} = \frac{\pi V_{\text{PEAK}}}{4V_{\text{CC}}}$$

The **maximum theoretical value** is reached when $V_{\text{PEAK}} = V_{\text{CC}}/2$, so:

$$\eta = \frac{\pi}{8} = 39.25\%$$

4.4.3 Total power dissipation

The TS4909 is a stereo (dual channel) amplifier. It has two independent power amplifiers. Each amplifier produces heat due to its power dissipation. Therefore the maximum die temperature is the sum of each amplifier's maximum power dissipation. It is calculated as follows:

- $P_{\text{diss } 1}$ = power dissipation due to the first channel power amplifier ($V_{\text{out}1}$).
- $P_{\text{diss } 2}$ = power dissipation due to the second channel power amplifier ($V_{\text{out}2}$).
- Total $P_{\text{diss}} = P_{\text{diss } 1} + P_{\text{diss } 2}$ (W)

In most cases, $P_{\text{diss } 1} = P_{\text{diss } 2}$, giving:

$$\text{Total } P_{\text{diss}} = 2P_{\text{diss}1} = 2P_{\text{diss}2}$$

Single-ended configuration:

$$\text{Total } P_{\text{diss}} = \frac{2\sqrt{2}V_{\text{CC}}}{\pi\sqrt{R_{\text{L}}}} \sqrt{P_{\text{OUT}}} - 2P_{\text{OUT}}$$

Phantom ground configuration:

$$\text{Total } P_{\text{diss}} = \frac{4\sqrt{2}V_{\text{CC}}}{\pi\sqrt{R_{\text{L}}}} \sqrt{P_{\text{OUT}}} - 2P_{\text{OUT}}$$

4.5 Decoupling of the circuit

Two capacitors are needed to properly bypass the TS4909 — a power supply capacitor C_{s} and a bias voltage bypass capacitor C_{b} .

C_{s} has a strong influence on the THD+N at high frequencies (above 7 kHz) and indirectly on the power supply disturbances. With 1 μF , you could expect the THD+N performance to be similar to the values shown in this datasheet. If C_{s} is lower than 1 μF , THD+N increases at high frequencies and disturbances on the power supply rail are less filtered. On the contrary, if C_{s} is higher than 1 μF , those disturbances on the power supply rail are more filtered.

C_{b} has an influence on THD+N at lower frequencies, but its value is critical on the final result of PSRR with inputs grounded at lower frequencies.

- If C_{b} is lower than 1 μF , THD+N increases at lower frequencies and the PSRR worsens (increases).
- If C_{b} is higher than 1 μF , the benefit on THD+N and PSRR in the lower frequency range is small.

4.6 Wake-up time

When the standby is released to turn the device ON, the bypass capacitor C_b is charged immediately. As C_b is directly linked to the bias of the amplifier, the bias will not work properly until the C_b voltage is correct. The time to reach this voltage plus a time delay of 40 ms (pop precaution) is called the wake-up time or t_{WU} . It is specified in the electrical characteristics tables with $C_b = 1 \mu F$ (see [Section 3: Electrical characteristics on page 7](#)).

If C_b has a value other than $1 \mu F$, you can calculate t_{WU} by using the following formulas, or read it directly from the graph in [Figure 82](#).

Single-ended configuration:

$$t_{WU} = \frac{C_b \cdot 2.5}{0.042} + 40 \quad [\text{ms}; \mu\text{F}]$$

Phantom ground configuration:

$$t_{WU} = \frac{C_b \cdot 2.5}{0.417} + 40 \quad [\text{ms}; \mu\text{F}]$$

Figure 82. Typical wake-up time vs. bypass capacitance

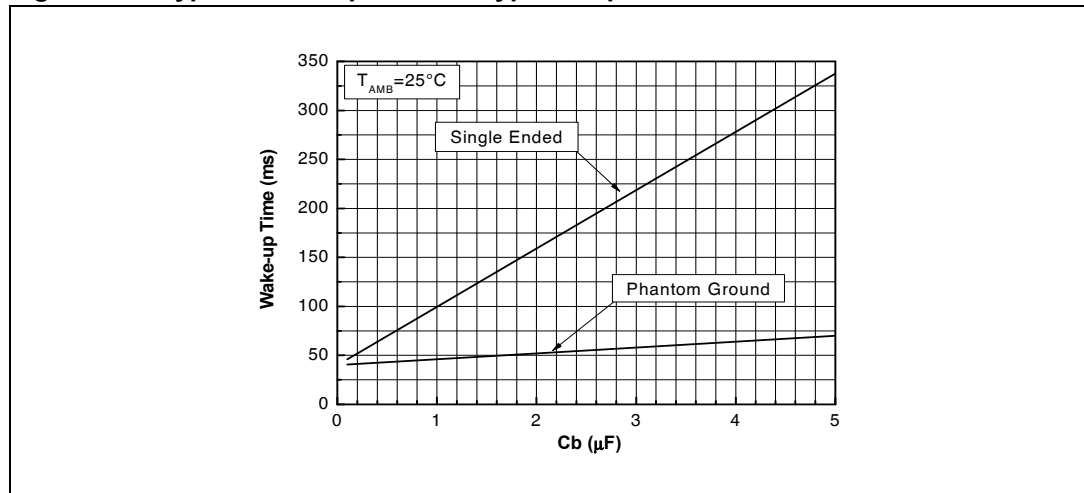

Note: It is assumed that the C_b voltage is equal to 0 V. If the C_b voltage is not equal to 0 V, the wake-up time is lower.

4.7 Pop performance

Pop performance in the phantom ground configuration is closely linked with the size of the input capacitor C_{in} . The size of C_{in} is dependent on the lower cut-off frequency and PSRR values requested.

In order to reach low pop, C_{in} must be charged to $V_{CC}/2$ in less than 40 ms. To follow this rule, the equivalent input constant time ($R_{in}C_{in}$) should be less than 8 ms.

$$\tau_{in} = R_{in} \times C_{in} < 0.008 \text{ s}$$

By following the previous rules, the TS4909 can reach low pop even with a high gain such as 20 dB.

Sample calculation

With $R_{in} = 20\text{ k}\Omega$ and $F_{CL} = 20\text{ Hz}$ and a -3 db low cut-off frequency, $C_{in} = 398\text{ nF}$.
 Therefore, $C_{in} = 390\text{ nF}$ with standard values which gives a lower cut-off frequency equal to 20.4 Hz.

In this case:

$$\tau_{in} = R_{in} \times C_{in} = 7.8\text{ ms}$$

This value is sufficient with regard to the previous formula, so we can state that the pop will be imperceptible.

Connecting the headphones

In general, the headphones are connected using a jack connector. To prevent pop in the headphones while plugging in the jack, a pulldown resistor should be connected in parallel with each headphone output. This allows the capacitors C_{out} to be charged even when no headphones are plugged in.

A resistor of 1 k Ω is high enough to be a negligible load, and low enough to charge the capacitors C_{out} in less than one second.

4.8 Standby mode

When the TS4909 is in standby mode, the time required to put the output stages (V_{out1} , V_{out2} and V_{out3}) into a high impedance state with reference to ground, and the internal circuitry in standby mode, is a few microseconds.

Figure 83. Internal equivalent circuit schematics of the TS4909 in standby mode

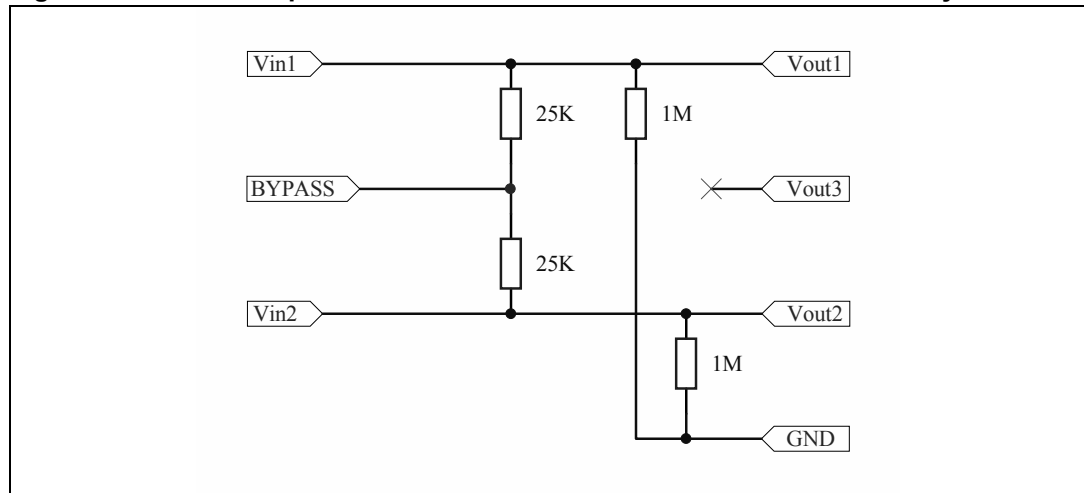

5 Package information

In order to meet environmental requirements, ST offers these devices in different grades of ECOPACK[®] packages, depending on their level of environmental compliance. ECOPACK[®] specifications, grade definitions and product status are available at: www.st.com. ECOPACK[®] is an ST trademark.

Figure 84. TS4909 footprint recommendation

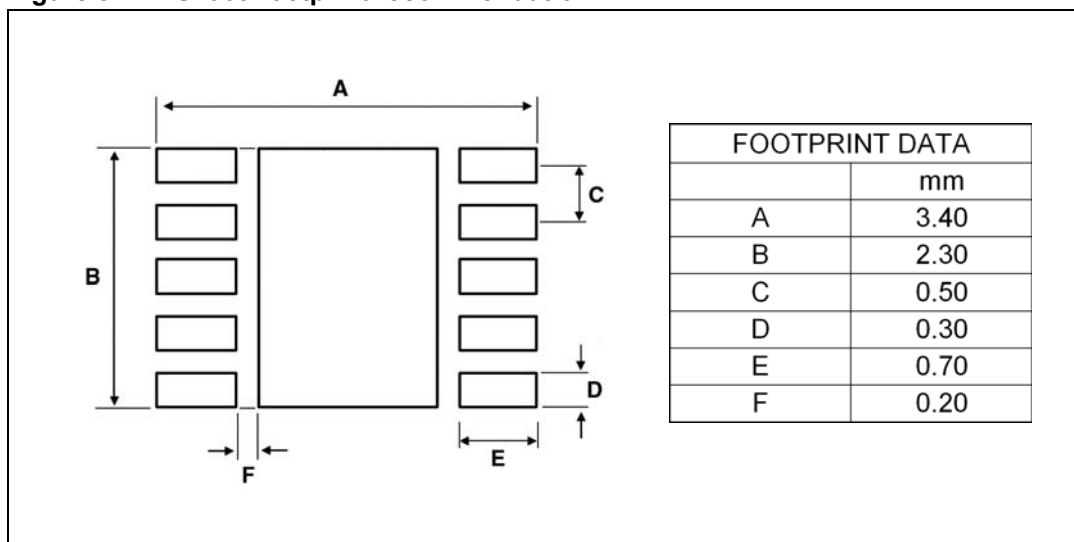

Figure 85. DFN10 3 x 3 pitch 0.5 mm exposed pad package mechanical drawing

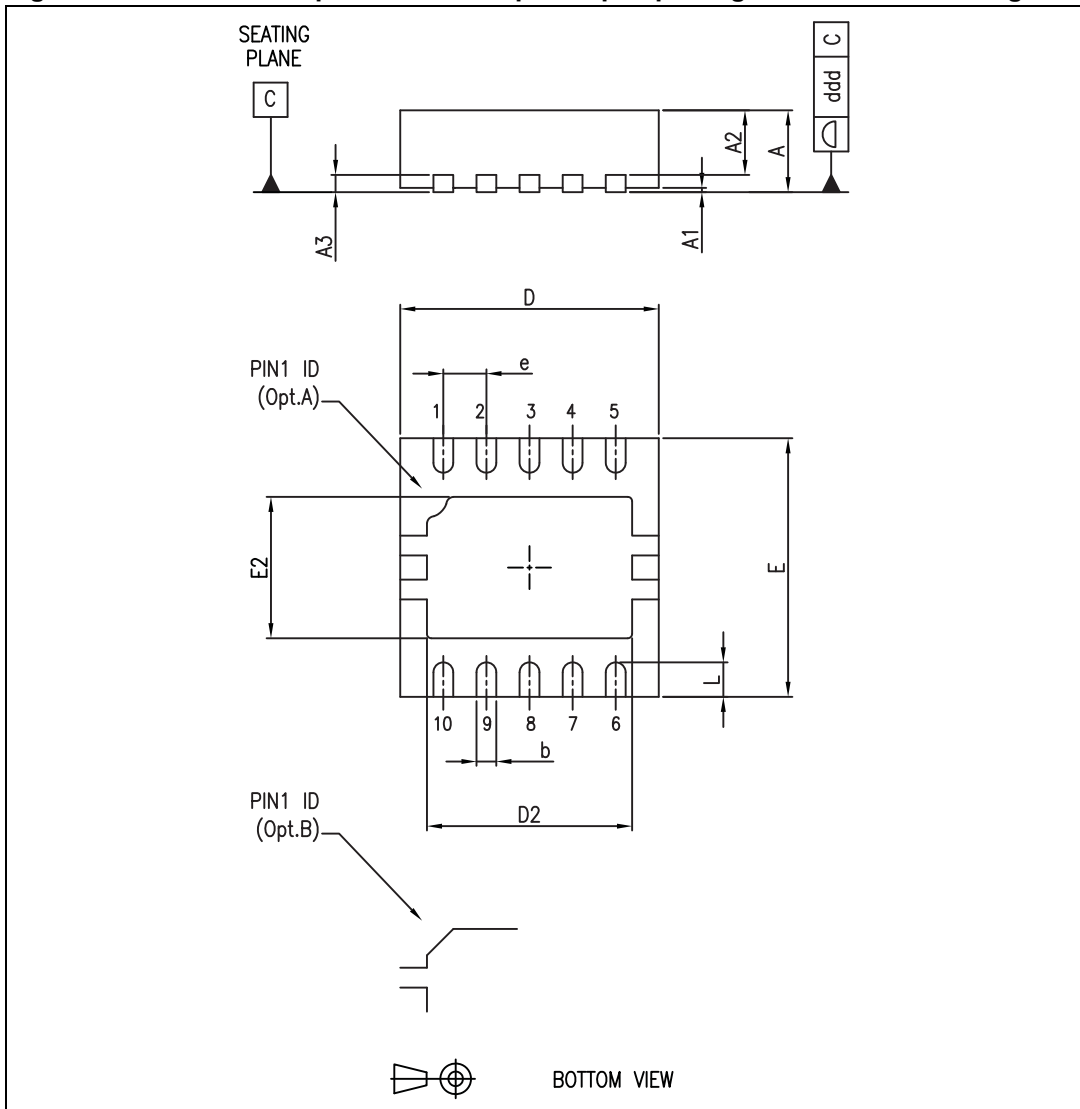

Table 7. DFN10 3 x 3 pitch 0.5 mm exposed pad package mechanical data

Ref.	Dimensions					
	Millimeters			Inches		
	Min.	Typ.	Max.	Min.	Typ.	Max.
A	0.80	0.90	1.00	0.031	0.035	0.040
A1		0.02	0.05		0.0008	0.002
A2	0.55	0.65	0.80	0.022	0.026	0.031
A3		0.20			0.008	
b	0.18	0.25	0.30	0.007	0.010	0.012
D	2.85	3.00	3.15	0.112	0.118	0.124
D2	2.20		2.70	0.087		0.106
E	2.85	3.00	3.15	0.112	0.118	0.124
E2	1.40		1.75	0.055		0.069
e		0.50			0.020	
L	0.30	0.40	0.50	0.012	0.016	0.020
ddd			0.08			0.003

Note: The DFN10 package has an exposed pad E2 x D2. For enhanced thermal performance, the exposed pad must be soldered to a copper area on the PCB, acting as a heatsink. This copper area can be electrically connected to pin 6 (GND) or left floating.

6 Ordering information

Table 8. Order codes

Part number	Temperature range	Package	Packing	Marking
TS4909IQT	-40°C to +85°C	DFN10	Tape & reel	K909

7 Revision history

Table 9. Document revision history

Date	Revision	Changes
01-Dec-2006	6	Release to production of the device.
02-Jan-2007	7	Correction of revision number of December revision (revision 6 instead of revision 5).
26-Sep-2007	8	Updated Table 2: Absolute maximum ratings .
14-Jan-2013	9	Added list of figures. Updated package information in Chapter 5 (drawing and data). Added note under Table 7 on page 32 regarding exposed pad connectivity.

Please Read Carefully:

Information in this document is provided solely in connection with ST products. STMicroelectronics NV and its subsidiaries ("ST") reserve the right to make changes, corrections, modifications or improvements, to this document, and the products and services described herein at any time, without notice.

All ST products are sold pursuant to ST's terms and conditions of sale.

Purchasers are solely responsible for the choice, selection and use of the ST products and services described herein, and ST assumes no liability whatsoever relating to the choice, selection or use of the ST products and services described herein.

No license, express or implied, by estoppel or otherwise, to any intellectual property rights is granted under this document. If any part of this document refers to any third party products or services it shall not be deemed a license grant by ST for the use of such third party products or services, or any intellectual property contained therein or considered as a warranty covering the use in any manner whatsoever of such third party products or services or any intellectual property contained therein.

UNLESS OTHERWISE SET FORTH IN ST'S TERMS AND CONDITIONS OF SALE ST DISCLAIMS ANY EXPRESS OR IMPLIED WARRANTY WITH RESPECT TO THE USE AND/OR SALE OF ST PRODUCTS INCLUDING WITHOUT LIMITATION IMPLIED WARRANTIES OF MERCHANTABILITY, FITNESS FOR A PARTICULAR PURPOSE (AND THEIR EQUIVALENTS UNDER THE LAWS OF ANY JURISDICTION), OR INFRINGEMENT OF ANY PATENT, COPYRIGHT OR OTHER INTELLECTUAL PROPERTY RIGHT.

UNLESS EXPRESSLY APPROVED IN WRITING BY TWO AUTHORIZED ST REPRESENTATIVES, ST PRODUCTS ARE NOT RECOMMENDED, AUTHORIZED OR WARRANTED FOR USE IN MILITARY, AIR CRAFT, SPACE, LIFE SAVING, OR LIFE SUSTAINING APPLICATIONS, NOR IN PRODUCTS OR SYSTEMS WHERE FAILURE OR MALFUNCTION MAY RESULT IN PERSONAL INJURY, DEATH, OR SEVERE PROPERTY OR ENVIRONMENTAL DAMAGE. ST PRODUCTS WHICH ARE NOT SPECIFIED AS "AUTOMOTIVE GRADE" MAY ONLY BE USED IN AUTOMOTIVE APPLICATIONS AT USER'S OWN RISK.

Resale of ST products with provisions different from the statements and/or technical features set forth in this document shall immediately void any warranty granted by ST for the ST product or service described herein and shall not create or extend in any manner whatsoever, any liability of ST.

ST and the ST logo are trademarks or registered trademarks of ST in various countries.

Information in this document supersedes and replaces all information previously supplied.

The ST logo is a registered trademark of STMicroelectronics. All other names are the property of their respective owners.

© 2013 STMicroelectronics - All rights reserved

STMicroelectronics group of companies

Australia - Belgium - Brazil - Canada - China - Czech Republic - Finland - France - Germany - Hong Kong - India - Israel - Italy - Japan - Malaysia - Malta - Morocco - Philippines - Singapore - Spain - Sweden - Switzerland - United Kingdom - United States of America

www.st.com

