

74LVC377

Octal D-type flip-flop with data enable; positive-edge trigger

Rev. 7 — 27 August 2021

Product data sheet

1. General description

The 74LVC377 is an octal positive-edge triggered D-type flip-flop. The device features clock (CP) and data enable (\bar{E}) inputs. When \bar{E} is LOW, the outputs Qn will assume the state of their corresponding D inputs that meet the set-up and hold time requirements on the LOW-to-HIGH clock (CP) transition. Input \bar{E} must be stable one set-up time prior to the LOW-to-HIGH transition for predictable operation. Inputs can be driven from either 3.3 V or 5 V devices. This feature allows the use of these devices as translators in mixed 3.3 V and 5 V environments.

2. Features and benefits

- Wide supply voltage range from 1.2 V to 3.6 V
- Overvoltage tolerant inputs to 5.5 V
- CMOS low power consumption
- Direct interface with TTL levels
- Output drive capability 50 Ω transmission lines at 125 °C
- Complies with JEDEC standard:
 - JESD8-7A (1.65 V to 1.95 V)
 - JESD8-5A (2.3 V to 2.7 V)
 - JESD8-C/JESD36 (2.7 V to 3.6 V)
- ESD protection:
 - HBM JESD22-A114F exceeds 2000 V
 - MM JESD22-A115-B exceeds 200 V
 - CDM JESD22-C101E exceeds 1000 V
- Specified from -40 °C to +85 °C and from -40 °C to +125 °C

3. Ordering information

Table 1. Ordering information

Type number	Package			Version
	Temperature range	Name	Description	
74LVC377D	-40 °C to +125 °C	SO20	plastic small outline package; 20 leads; body width 7.5 mm	SOT163-1
74LVC377PW	-40 °C to +125 °C	TSSOP20	plastic thin shrink small outline package; 20 leads; body width 4.4 mm	SOT360-1

4. Functional diagram

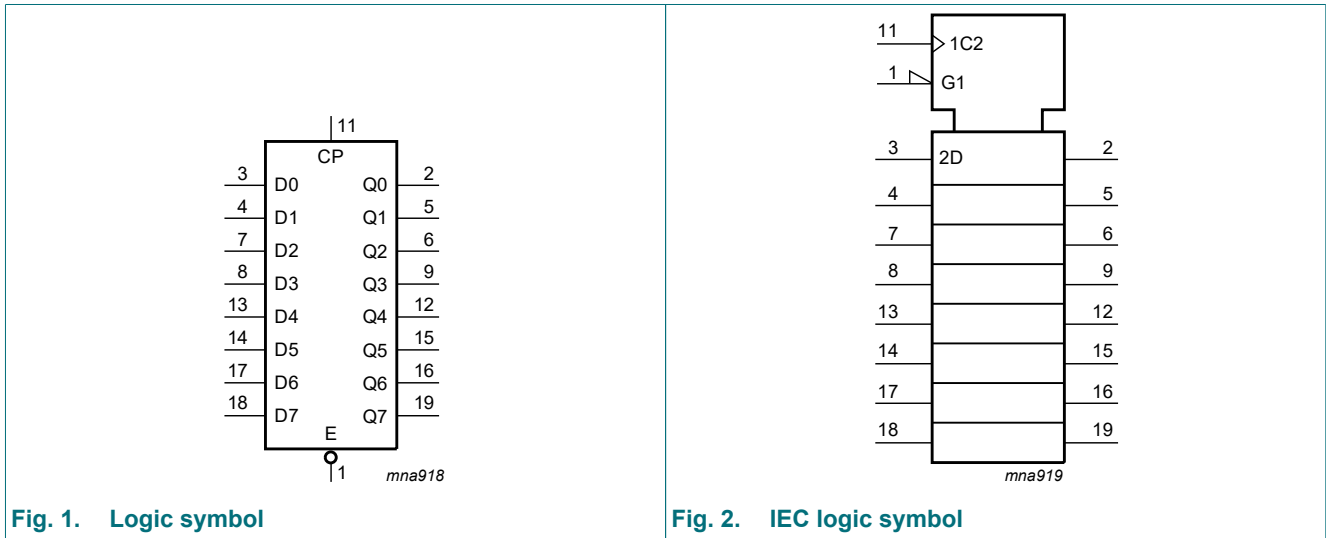

Fig. 1. Logic symbol

Fig. 2. IEC logic symbol

5. Pinning information

5.1. Pinning

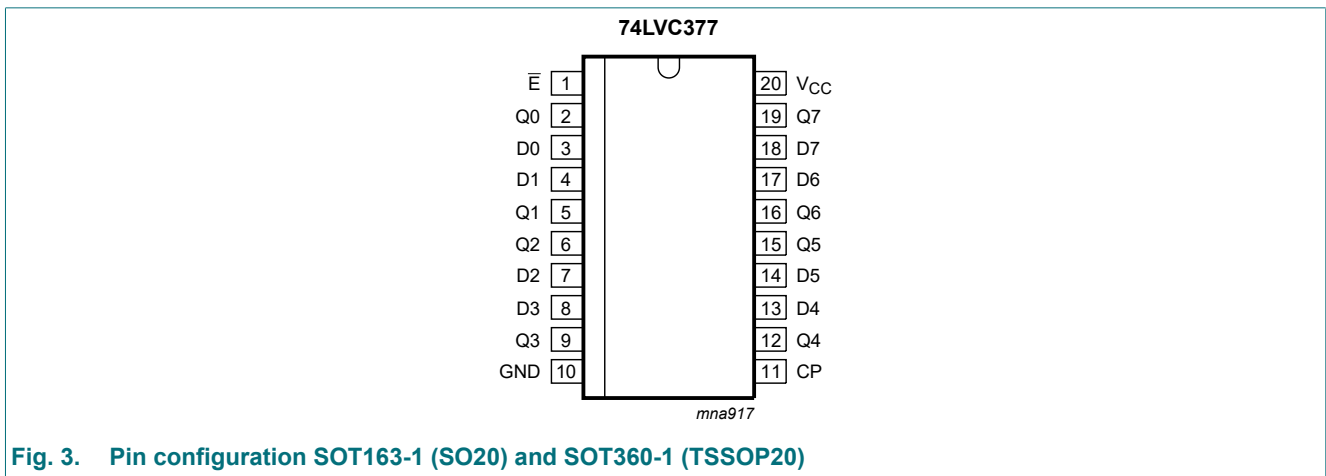

Fig. 3. Pin configuration SOT163-1 (SO20) and SOT360-1 (TSSOP20)

5.2. Pin description

Table 2. Pin description

Symbol	Pin	Description
\bar{E}	1	data enable input (active LOW)
CP	11	clock input (LOW to HIGH; edge-triggered)
D0, D1, D2, D3, D4, D5, D6, D7	3, 4, 7, 8, 13, 14, 17, 18	data input
Q0, Q1, Q2, Q3, Q4, Q5, Q6, Q7	2, 5, 6, 9, 12, 15, 16, 19	flip-flop output
GND	10	ground (0 V)
V _{CC}	20	power supply

6. Functional description

Table 3. Function table

H = HIGH voltage level; h = HIGH voltage level one set-up time prior to the LOW to HIGH CP transition

L = LOW voltage level; l = LOW voltage level one set-up time prior to the LOW to HIGH CP transition

↑ = LOW to HIGH CP transition; NC = no change; X = don't care

Operating mode	Control		Input	Output
	CP	E	Dn	Qn
Load 1	↑	l	h	H
Load 0	↑	l	l	L
Hold	↑	h	X	NC
Do nothing	X	H	X	NC

7. Limiting values

Table 4. Limiting values

In accordance with the Absolute Maximum Rating System (IEC 60134). Voltages are referenced to GND (ground = 0 V).

Symbol	Parameter	Conditions	Min	Max	Unit
V_{CC}	supply voltage		-0.5	+6.5	V
V_I	input voltage		[1] -0.5	+5.5	V
V_O	output voltage		[2] -0.5	$V_{CC} + 0.5$	V
I_{IK}	input clamping current	$V_I < 0\text{ V}$	-50	-	mA
I_O	output current	$V_O = 0\text{ V to }V_{CC}$	-	±50	mA
I_{OK}	output clamping current	$V_O > V_{CC}$ or $V_O < 0\text{ V}$	-	±50	mA
I_{CC}	supply current		-	100	mA
I_{GND}	ground current		-100	-	mA
T_{stg}	storage temperature		-65	+150	°C
P_{tot}	total power dissipation	$T_{amb} = -40\text{ °C to }+125\text{ °C}$	[3] -	500	mW

[1] The minimum input voltage ratings may be exceeded if the input current ratings are observed.

[2] The output voltage ratings may be exceeded if the output current ratings are observed.

[3] For SOT163-1 (SO20) package: P_{tot} derates linearly with 12.3 mW/K above 109 °C.
For SOT360-1 (TSSOP20) package: P_{tot} derates linearly with 10.0 mW/K above 100 °C.

8. Recommended operating conditions

Table 5. Recommended operating conditions

Symbol	Parameter	Conditions	Min	Typ	Max	Unit
V_{CC}	supply voltage		1.65	-	3.6	V
		functional	1.2	-	-	V
V_I	input voltage		0	-	5.5	V
V_O	output voltage		0	-	V_{CC}	V
T_{amb}	ambient temperature	in free air	-40	-	+125	°C
$\Delta t/\Delta V$	input transition rise and fall rate	$V_{CC} = 1.65\text{ V to }2.7\text{ V}$	0	-	20	ns/V
		$V_{CC} = 2.7\text{ V to }3.6\text{ V}$	0	-	10	ns/V

9. Static characteristics

Table 6. Static characteristics

At recommended operating conditions. Voltages are referenced to GND (ground = 0 V).

Symbol	Parameter	Conditions	-40 °C to +85 °C			-40 °C to +125 °C		Unit
			Min	Typ [1]	Max	Min	Max	
V _{IH}	HIGH-level input voltage	V _{CC} = 1.2 V	1.08	-	-	1.08	-	V
		V _{CC} = 1.65 V to 1.95 V	0.65V _{CC}	-	-	0.65V _{CC}	-	V
		V _{CC} = 2.3 V to 2.7 V	1.7	-	-	1.7	-	V
		V _{CC} = 2.7 V to 3.6 V	2.0	-	-	2.0	-	V
V _{IL}	LOW-level input voltage	V _{CC} = 1.2 V	-	-	0.12	-	0.12	V
		V _{CC} = 1.65 V to 1.95 V	-	-	0.35V _{CC}	-	0.35V _{CC}	V
		V _{CC} = 2.3 V to 2.7 V	-	-	0.7	-	0.7	V
		V _{CC} = 2.7 V to 3.6 V	-	-	0.8	-	0.8	V
V _{OH}	HIGH-level output voltage	V _I = V _{IH} or V _{IL}						
		I _O = -100 µA; V _{CC} = 1.65 V to 3.6 V	V _{CC} - 0.2	-	-	V _{CC} - 0.3	-	V
		I _O = -4 mA; V _{CC} = 1.65 V	1.2	-	-	1.05	-	V
		I _O = -8 mA; V _{CC} = 2.3 V	1.8	-	-	1.65	-	V
		I _O = -12 mA; V _{CC} = 2.7 V	2.2	-	-	2.05	-	V
		I _O = -18 mA; V _{CC} = 3.0 V	2.4	-	-	2.25	-	V
V _{OL}	LOW-level output voltage	V _I = V _{IH} or V _{IL}						
		I _O = 100 µA; V _{CC} = 1.65 V to 3.6 V	-	-	0.2	-	0.3	V
		I _O = 4 mA; V _{CC} = 1.65 V	-	-	0.45	-	0.65	V
		I _O = 8 mA; V _{CC} = 2.3 V	-	-	0.6	-	0.8	V
		I _O = 12 mA; V _{CC} = 2.7 V	-	-	0.4	-	0.6	V
		I _O = 24 mA; V _{CC} = 3.0 V	-	-	0.55	-	0.8	V
I _I	input leakage current	V _{CC} = 3.6 V; V _I = 5.5 V or GND	-	±0.1	±5	-	±20	µA
I _{CC}	supply current	V _{CC} = 3.6 V; V _I = V _{CC} or GND; I _O = 0 A	-	0.1	10	-	40	µA
ΔI _{CC}	additional supply current	per input pin; V _{CC} = 2.7 V to 3.6 V; V _I = V _{CC} - 0.6 V; I _O = 0 A	-	5	500	-	5000	µA
C _I	input capacitance	V _{CC} = 0 V to 3.6 V; V _I = GND to V _{CC}	-	5.0	-	-	-	pF

[1] All typical values are measured at V_{CC} = 3.3 V (unless stated otherwise) and T_{amb} = 25 °C.

10. Dynamic characteristics

Table 7. Dynamic characteristics

Voltages are referenced to GND (ground = 0 V). For test circuit see Fig. 6.

Symbol	Parameter	Conditions	-40 °C to +85 °C			-40 °C to +125 °C		Unit
			Min	Typ [1]	Max	Min	Max	
t_{pd}	propagation delay	CP to Qn; see Fig. 4 [2]						
		$V_{CC} = 1.2\text{ V}$	-	15	-	-	-	ns
		$V_{CC} = 1.65\text{ V to }1.95\text{ V}$	2.5	7.4	14.5	2.5	15.5	ns
		$V_{CC} = 2.3\text{ V to }2.7\text{ V}$	1.8	4.4	8.5	1.8	9.1	ns
		$V_{CC} = 2.7\text{ V}$	1.5	4.3	7.9	1.5	10.0	ns
		$V_{CC} = 3.0\text{ V to }3.6\text{ V}$	1.5	4.0	7.6	1.5	9.5	ns
t_W	pulse width	clock HIGH or LOW; see Fig. 4						
		$V_{CC} = 1.65\text{ V to }1.95\text{ V}$	6.0	-	-	6.0	-	ns
		$V_{CC} = 2.3\text{ V to }2.7\text{ V}$	5.0	-	-	5.0	-	ns
		$V_{CC} = 2.7\text{ V}$	5.0	1.6	-	5.0	-	ns
		$V_{CC} = 3.0\text{ V to }3.6\text{ V}$	4.0	1.0	-	4.0	-	ns
t_{su}	set-up time	\bar{E} to CP; see Fig. 5						
		$V_{CC} = 1.65\text{ V to }1.95\text{ V}$	5.5	-	-	5.5	-	ns
		$V_{CC} = 2.3\text{ V to }2.7\text{ V}$	4.5	-	-	4.5	-	ns
		$V_{CC} = 2.7\text{ V}$	4.0	0.6	-	4.0	-	ns
		$V_{CC} = 3.0\text{ V to }3.6\text{ V}$	3.0	0.2	-	3.0	-	ns
		Dn to CP; see Fig. 5						
		$V_{CC} = 1.65\text{ V to }1.95\text{ V}$	5.5	-	-	5.5	-	ns
		$V_{CC} = 2.3\text{ V to }2.7\text{ V}$	4.5	-	-	4.5	-	ns
		$V_{CC} = 2.7\text{ V}$	3.0	1.0	-	3.0	-	ns
		$V_{CC} = 3.0\text{ V to }3.6\text{ V}$	2.0	0.7	-	2.0	-	ns
t_h	hold time	\bar{E} to CP; see Fig. 5						
		$V_{CC} = 1.65\text{ V to }1.95\text{ V}$	1.5	-	-	1.5	-	ns
		$V_{CC} = 2.3\text{ V to }2.7\text{ V}$	0.5	-	-	0.5	-	ns
		$V_{CC} = 2.7\text{ V}$	0.0	-1.0	-	0.0	-	ns
		$V_{CC} = 3.0\text{ V to }3.6\text{ V}$	1.0	0	-	1.0	-	ns
		Dn to CP; see Fig. 5						
		$V_{CC} = 1.65\text{ V to }1.95\text{ V}$	1.5	-	-	1.5	-	ns
		$V_{CC} = 2.3\text{ V to }2.7\text{ V}$	0.5	-	-	0.5	-	ns
		$V_{CC} = 2.7\text{ V}$	0.0	-1.1	-	0.0	-	ns
		$V_{CC} = 3.0\text{ V to }3.6\text{ V}$	0.0	-1.0	-	0.0	-	ns
f_{max}	maximum frequency	see Fig. 4						
		$V_{CC} = 1.65\text{ V to }1.95\text{ V}$	80	-	-	64	-	MHz
		$V_{CC} = 2.3\text{ V to }2.7\text{ V}$	100	-	-	80	-	MHz
		$V_{CC} = 2.7\text{ V}$	150	-	-	120	-	MHz
		$V_{CC} = 3.0\text{ V to }3.6\text{ V}$	150	330	-	120	-	MHz
$t_{sk(o)}$	output skew time	$V_{CC} = 3.0\text{ V to }3.6\text{ V}$ [3]	-	-	1.0	-	1.5	ns

Octal D-type flip-flop with data enable; positive-edge trigger

Symbol	Parameter	Conditions	-40 °C to +85 °C			-40 °C to +125 °C		Unit
			Min	Typ [1]	Max	Min	Max	
C _{PD}	power dissipation capacitance	per flip-flop; V _I = GND to V _{CC} [4]						
		V _{CC} = 1.65 V to 1.95 V	-	12.1	-	-	-	pF
		V _{CC} = 2.3 V to 2.7 V	-	15.8	-	-	-	pF
		V _{CC} = 3.0 V to 3.6 V	-	19.0	-	-	-	pF

- [1] Typical values are measured at T_{amb} = 25 °C and V_{CC} = 1.2 V, 1.8 V, 2.5 V, 2.7 V and 3.3 V respectively.
- [2] t_{pd} is the same as t_{PLH} and t_{PHL}.
- [3] Skew between any two outputs of the same package switching in the same direction. This parameter is guaranteed by design.
- [4] C_{PD} is used to determine the dynamic power dissipation (P_D in μW).
 $P_D = C_{PD} \times V_{CC}^2 \times f_i \times N + \Sigma(C_L \times V_{CC}^2 \times f_o)$ where:
 f_i = input frequency in MHz; f_o = output frequency in MHz
 C_L = output load capacitance in pF
 V_{CC} = supply voltage in Volts
 N = number of inputs switching
 Σ(C_L × V_{CC}² × f_o) = sum of the outputs

10.1. Waveforms and test circuit

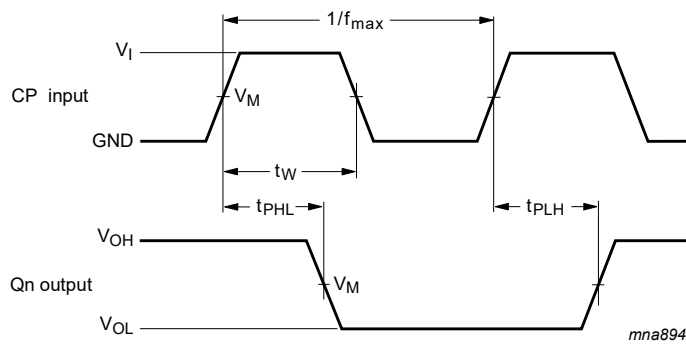

Measurement points are given in Table 8.
 Logic levels: V_{OL} and V_{OH} are typical output voltage levels that occur with the output load.

Fig. 4. Propagation delay clock (CP) to output (Qn), pulse width clock (CP), and maximum frequency

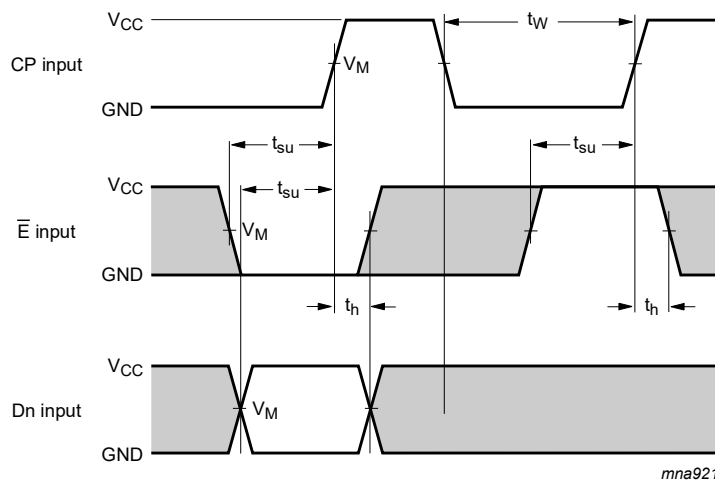

Measurement points are given in Table 8.
 The shaded areas indicate when the input is permitted to change for predictable output performance.

Fig. 5. Data set-up and hold times of data input (Dn) and enable input (E) and pulse width of enable input (E)

Octal D-type flip-flop with data enable; positive-edge trigger

Table 8. Measurement points

Supply voltage	Input	Output
V_{CC}	V_M	V_M
1.2 V	$0.5 \times V_{CC}$	$0.5 \times V_{CC}$
1.65 V to 1.95V	$0.5 \times V_{CC}$	$0.5 \times V_{CC}$
2.3 V to 2.7 V	$0.5 \times V_{CC}$	$0.5 \times V_{CC}$
2.7 V	1.5 V	1.5 V
3.0 V to 3.6 V	1.5 V	1.5 V

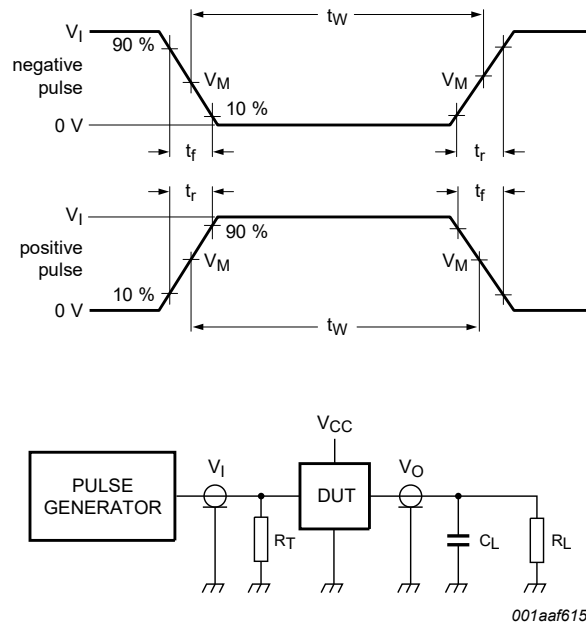

Test data is given in [Table 9](#).

Definitions for test circuit:

R_L = Load resistance.

C_L = Load capacitance including jig and probe capacitance.

R_T = Termination resistance should be equal to output impedance Z_o of the pulse generator.

Fig. 6. Test circuit for switching times

Table 9. Test data

Supply voltage	Input		Load	
	V_I	t_r, t_f	C_L	R_L
1.2 V	V_{CC}	≤ 2 ns	30 pF	1 k Ω
1.65 V to 1.95 V	V_{CC}	≤ 2 ns	30 pF	1 k Ω
2.3 V to 2.7 V	V_{CC}	≤ 2 ns	30 pF	500 Ω
2.7 V	2.7 V	≤ 2.5 ns	50 pF	500 Ω
3.0 V to 3.6 V	2.7 V	≤ 2.5 ns	50 pF	500 Ω

11. Package outline

SO20: plastic small outline package; 20 leads; body width 7.5 mm

SOT163-1

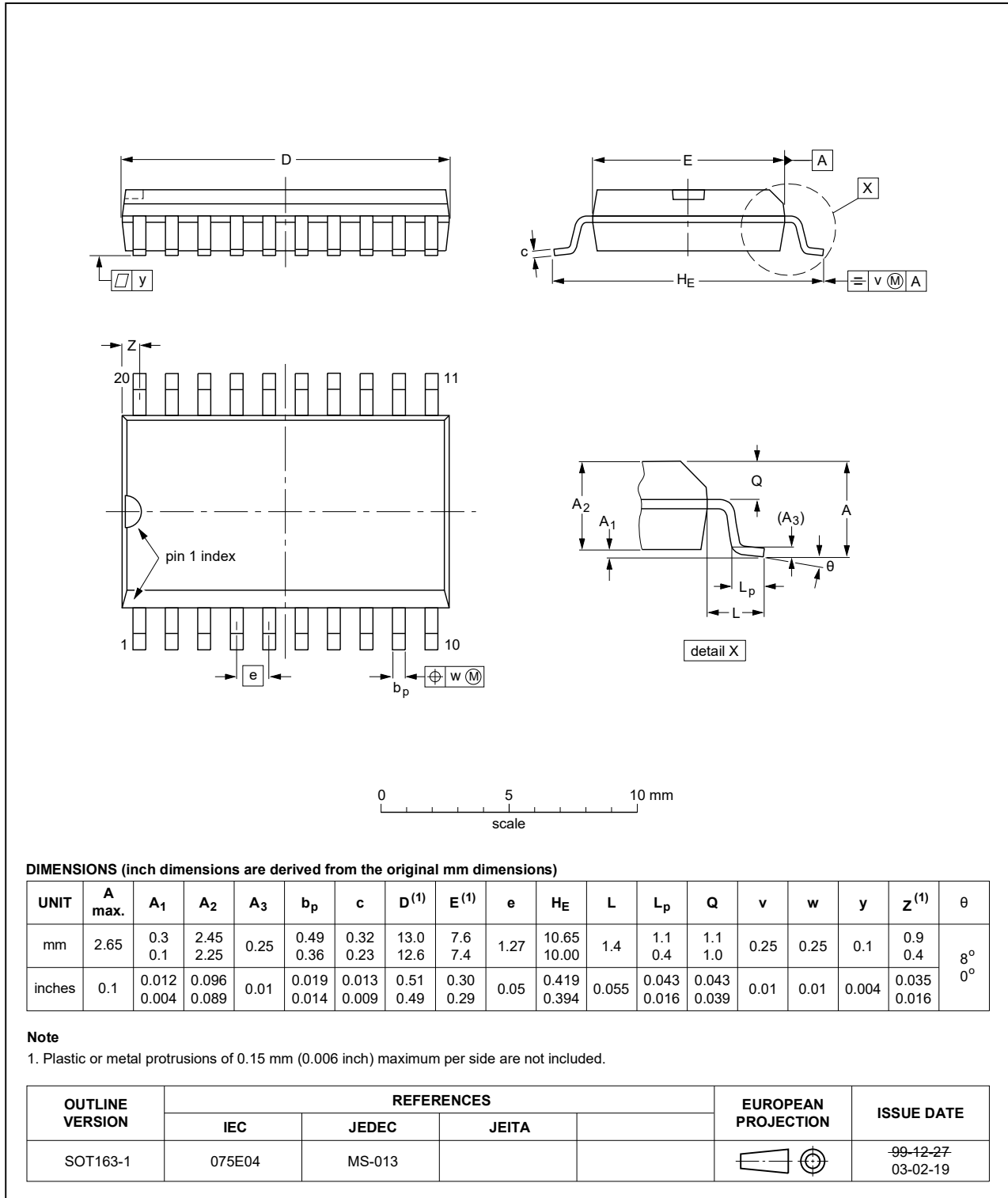

Fig. 7. Package outline SOT163-1 (SO20)

TSSOP20: plastic thin shrink small outline package; 20 leads; body width 4.4 mm

SOT360-1

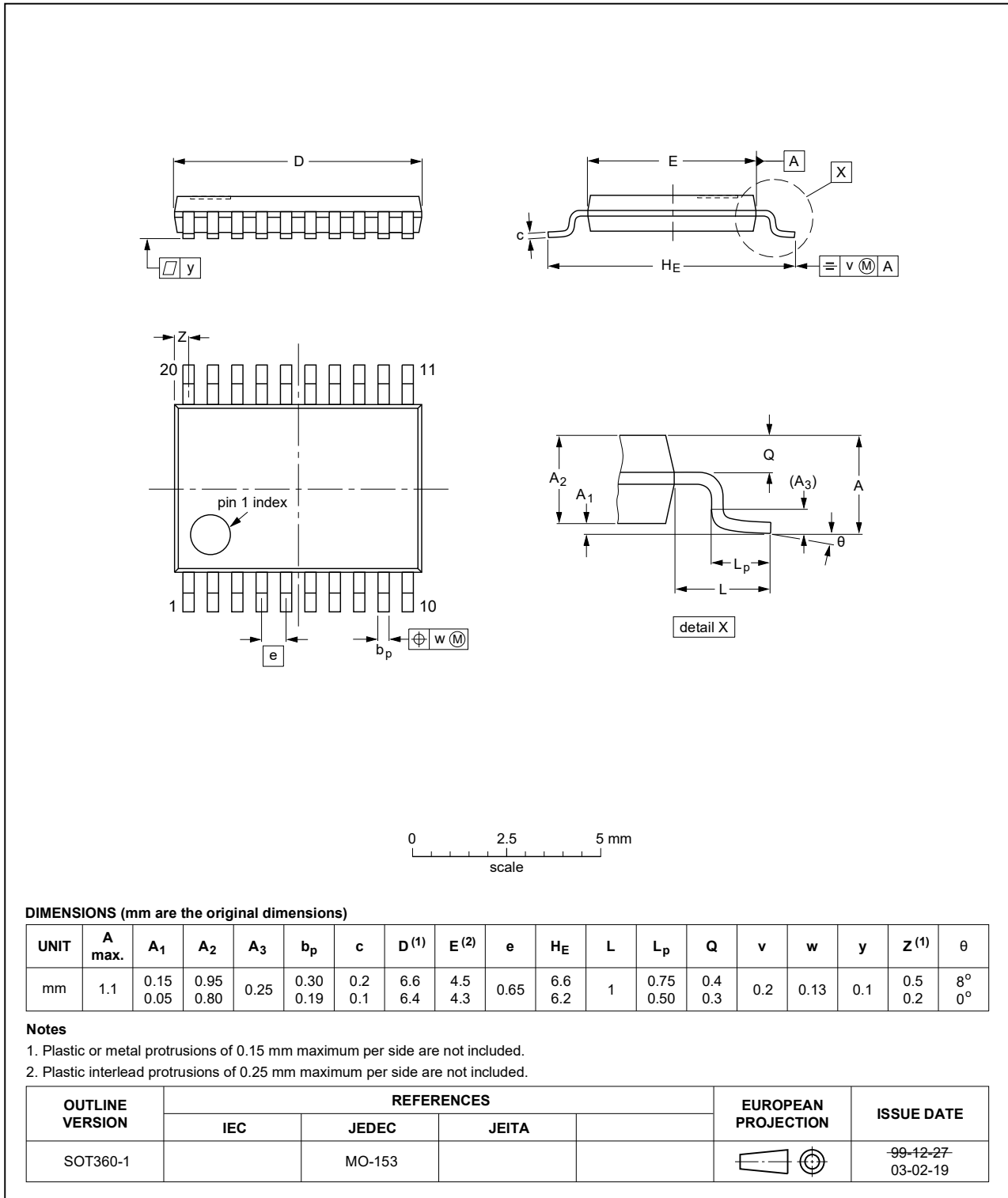

Fig. 8. Package outline SOT360-1 (TSSOP20)

12. Abbreviations

Table 10. Abbreviations

Acronym	Description
CDM	Charged Device Model
CMOS	Complementary Metal-Oxide Semiconductor
DUT	Device Under Test
ESD	ElectroStatic Discharge
HBM	Human Body Model
MM	Machine Model
TTL	Transistor-Transistor Logic

13. Revision history

Table 11. Revision history

Document ID	Release date	Data sheet status	Change notice	Supersedes
74LVC377 v.7	20210827	Product data sheet	-	74LVC377 v.6
Modifications:	<ul style="list-style-type: none"> The format of this data sheet has been redesigned to comply with the identity guidelines of Nexperia. Legal texts have been adapted to the new company name where appropriate. Section 1 updated. Type number 74LVC377DB (SOT339-1/SSOP20) removed. Section 7: Derating values for P_{tot} total power dissipation updated. 			
74LVC377 v.6	20121120	Product data sheet	-	74LVC377 v.5
Modifications:	<ul style="list-style-type: none"> The format of this data sheet has been redesigned to comply with the new identity guidelines of NXP Semiconductors. Legal texts have been adapted to the new company name where appropriate. Table 4, Table 5, Table 6, Table 7, Table 8, and Table 9: values added for lower voltage ranges. 			
74LVC377 v.5	20050221	Product specification	-	74LVC377 v.4
74LVC377 v.4	20040528	Product specification	-	74LVC377 v.3
74LVC377 v.3	20021023	Product specification	-	74LVC377 v.2
74LVC377 v.2	19980729	Product specification	-	74LVC377 v.1
74LVC377 v.1	19990606	Product specification	-	-

14. Legal information

Data sheet status

Document status [1][2]	Product status [3]	Definition
Objective [short] data sheet	Development	This document contains data from the objective specification for product development.
Preliminary [short] data sheet	Qualification	This document contains data from the preliminary specification.
Product [short] data sheet	Production	This document contains the product specification.

- [1] Please consult the most recently issued document before initiating or completing a design.
- [2] The term 'short data sheet' is explained in section "Definitions".
- [3] The product status of device(s) described in this document may have changed since this document was published and may differ in case of multiple devices. The latest product status information is available on the internet at <https://www.nexperia.com>.

Definitions

Draft — The document is a draft version only. The content is still under internal review and subject to formal approval, which may result in modifications or additions. Nexperia does not give any representations or warranties as to the accuracy or completeness of information included herein and shall have no liability for the consequences of use of such information.

Short data sheet — A short data sheet is an extract from a full data sheet with the same product type number(s) and title. A short data sheet is intended for quick reference only and should not be relied upon to contain detailed and full information. For detailed and full information see the relevant full data sheet, which is available on request via the local Nexperia sales office. In case of any inconsistency or conflict with the short data sheet, the full data sheet shall prevail.

Product specification — The information and data provided in a Product data sheet shall define the specification of the product as agreed between Nexperia and its customer, unless Nexperia and customer have explicitly agreed otherwise in writing. In no event however, shall an agreement be valid in which the Nexperia product is deemed to offer functions and qualities beyond those described in the Product data sheet.

Disclaimers

Limited warranty and liability — Information in this document is believed to be accurate and reliable. However, Nexperia does not give any representations or warranties, expressed or implied, as to the accuracy or completeness of such information and shall have no liability for the consequences of use of such information. Nexperia takes no responsibility for the content in this document if provided by an information source outside of Nexperia.

In no event shall Nexperia be liable for any indirect, incidental, punitive, special or consequential damages (including - without limitation - lost profits, lost savings, business interruption, costs related to the removal or replacement of any products or rework charges) whether or not such damages are based on tort (including negligence), warranty, breach of contract or any other legal theory.

Notwithstanding any damages that customer might incur for any reason whatsoever, Nexperia's aggregate and cumulative liability towards customer for the products described herein shall be limited in accordance with the Terms and conditions of commercial sale of Nexperia.

Right to make changes — Nexperia reserves the right to make changes to information published in this document, including without limitation specifications and product descriptions, at any time and without notice. This document supersedes and replaces all information supplied prior to the publication hereof.

Suitability for use — Nexperia products are not designed, authorized or warranted to be suitable for use in life support, life-critical or safety-critical systems or equipment, nor in applications where failure or malfunction of an Nexperia product can reasonably be expected to result in personal

injury, death or severe property or environmental damage. Nexperia and its suppliers accept no liability for inclusion and/or use of Nexperia products in such equipment or applications and therefore such inclusion and/or use is at the customer's own risk.

Quick reference data — The Quick reference data is an extract of the product data given in the Limiting values and Characteristics sections of this document, and as such is not complete, exhaustive or legally binding.

Applications — Applications that are described herein for any of these products are for illustrative purposes only. Nexperia makes no representation or warranty that such applications will be suitable for the specified use without further testing or modification.

Customers are responsible for the design and operation of their applications and products using Nexperia products, and Nexperia accepts no liability for any assistance with applications or customer product design. It is customer's sole responsibility to determine whether the Nexperia product is suitable and fit for the customer's applications and products planned, as well as for the planned application and use of customer's third party customer(s). Customers should provide appropriate design and operating safeguards to minimize the risks associated with their applications and products.

Nexperia does not accept any liability related to any default, damage, costs or problem which is based on any weakness or default in the customer's applications or products, or the application or use by customer's third party customer(s). Customer is responsible for doing all necessary testing for the customer's applications and products using Nexperia products in order to avoid a default of the applications and the products or of the application or use by customer's third party customer(s). Nexperia does not accept any liability in this respect.

Limiting values — Stress above one or more limiting values (as defined in the Absolute Maximum Ratings System of IEC 60134) will cause permanent damage to the device. Limiting values are stress ratings only and (proper) operation of the device at these or any other conditions above those given in the Recommended operating conditions section (if present) or the Characteristics sections of this document is not warranted. Constant or repeated exposure to limiting values will permanently and irreversibly affect the quality and reliability of the device.

Terms and conditions of commercial sale — Nexperia products are sold subject to the general terms and conditions of commercial sale, as published at <http://www.nexperia.com/profile/terms>, unless otherwise agreed in a valid written individual agreement. In case an individual agreement is concluded only the terms and conditions of the respective agreement shall apply. Nexperia hereby expressly objects to applying the customer's general terms and conditions with regard to the purchase of Nexperia products by customer.

No offer to sell or license — Nothing in this document may be interpreted or construed as an offer to sell products that is open for acceptance or the grant, conveyance or implication of any license under any copyrights, patents or other industrial or intellectual property rights.

Export control — This document as well as the item(s) described herein may be subject to export control regulations. Export might require a prior authorization from competent authorities.

Non-automotive qualified products — Unless this data sheet expressly states that this specific Nexperia product is automotive qualified, the product is not suitable for automotive use. It is neither qualified nor tested in accordance with automotive testing or application requirements. Nexperia accepts no liability for inclusion and/or use of non-automotive qualified products in automotive equipment or applications.

In the event that customer uses the product for design-in and use in automotive applications to automotive specifications and standards, customer (a) shall use the product without Nexperia's warranty of the product for such automotive applications, use and specifications, and (b) whenever customer uses the product for automotive applications beyond Nexperia's specifications such use shall be solely at customer's own risk, and (c) customer fully indemnifies Nexperia for any liability, damages or failed product claims resulting from customer design and use of the product for automotive applications beyond Nexperia's standard warranty and Nexperia's product specifications.

Translations — A non-English (translated) version of a document is for reference only. The English version shall prevail in case of any discrepancy between the translated and English versions.

Trademarks

Notice: All referenced brands, product names, service names and trademarks are the property of their respective owners.

Contents

1. General description	1
2. Features and benefits	1
3. Ordering information	1
4. Functional diagram	2
5. Pinning information	2
5.1. Pinning.....	2
5.2. Pin description.....	2
6. Functional description	3
7. Limiting values	3
8. Recommended operating conditions	3
9. Static characteristics	4
10. Dynamic characteristics	5
10.1. Waveforms and test circuit.....	6
11. Package outline	8
12. Abbreviations	10
13. Revision history	10
14. Legal information	11

© Nexperia B.V. 2021. All rights reserved

For more information, please visit: <http://www.nexperia.com>
For sales office addresses, please send an email to: salesaddresses@nexperia.com
Date of release: 27 August 2021
