

Xinger®

Ultra Small Low Profile 0603 Balun 50Ω to 200Ω Balanced

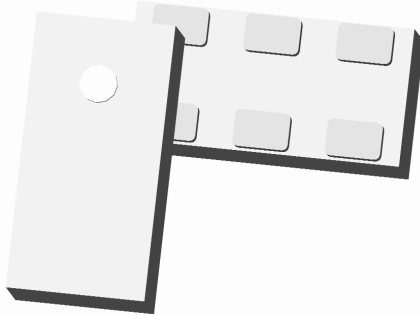

Description

The BD2326L50200AHF is an ultra-small low profile balanced to unbalanced transformer designed for differential inputs and output locations on next generation wireless chipsets in an easy to use surface mount package covering 802.11b+g+n. The BD2326L50200AHF is ideal for high volume manufacturing and is higher performance than traditional ceramic baluns. The BD2326L50200AHF has an unbalanced port impedance of 50Ω and a 200Ω balanced port impedance. This transformation enables single ended signals to be applied to differential ports on modern integrated chipsets. The output ports have equal amplitude (-3dB) with 180 degree phase differential. The BD2326L50200AHF is available on tape and reel for pick and place high volume manufacturing.

Detailed Electrical Specifications: Specifications subject to change without notice.

Features:	Parameter	ROOM (25°C)			Unit	
		Min.	Typ.	Max		
<ul style="list-style-type: none"> • 2300 – 2600 MHz • 0.7mm Height Profile • 50 Ohm to 2 x 100 Ohm • 802.11 b+g +n Compliant • Low Insertion Loss • Input to Output DC Isolation • Surface Mountable • Tape & Reel • Non-conductive Surface • RoHS Compliant • Halogen Free 	Frequency	2300		2600	MHz	
	Unbalanced Port Impedance		50		Ω	
	Balanced Port Impedance		200		Ω	
	Return Loss	12	18		dB	
	Insertion Loss*		0.9	1.1	dB	
	Amplitude Balance		0.4	0.8	dB	
	Phase Balance		3	9	Degrees	
	CMRR		29		dB	
	Power Handling			2	Watts	
	Operating Temperature		-55		+85	°C

* Insertion Loss stated at room temperature (Insertion Loss is approximately 0.1 dB higher at +85 °C) Outline Drawing

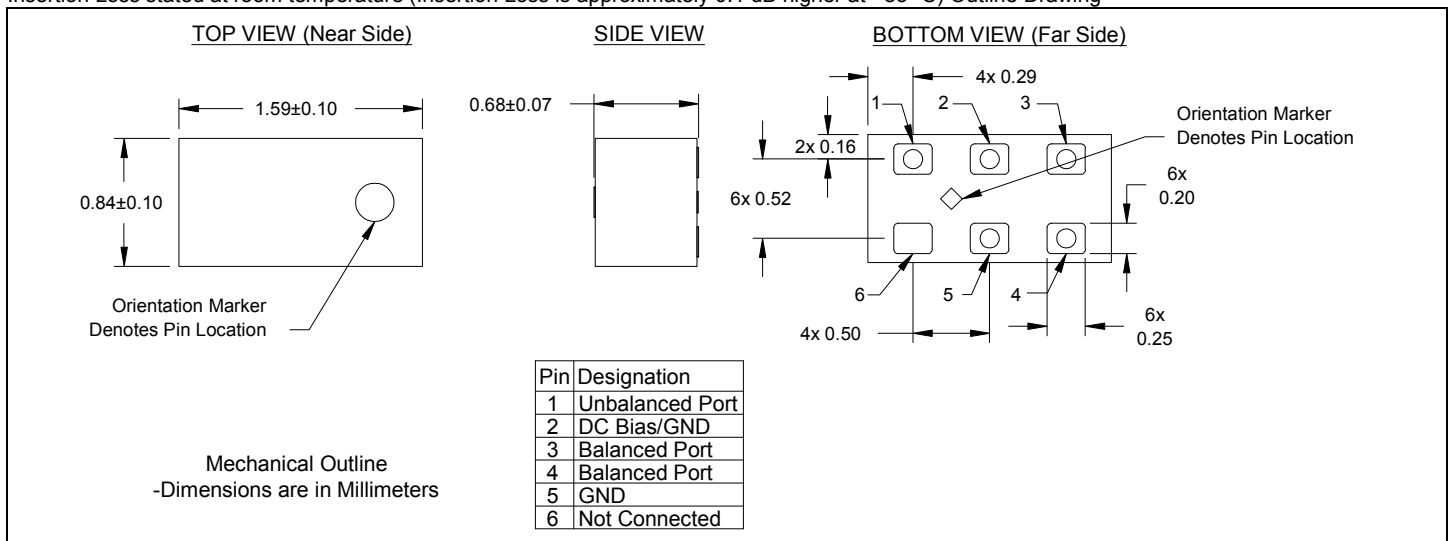

Typical Broadband Performance: 500 MHz. to 8000 MHz.

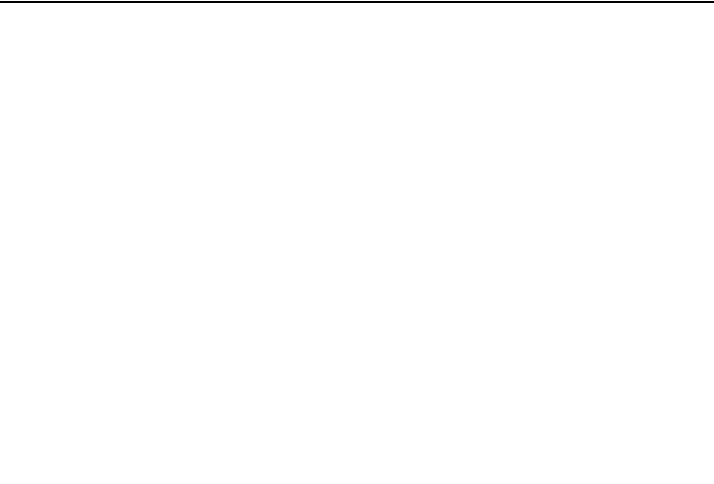
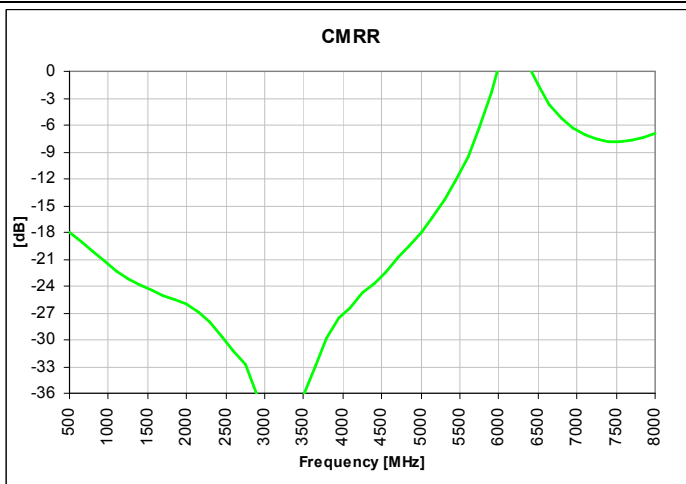
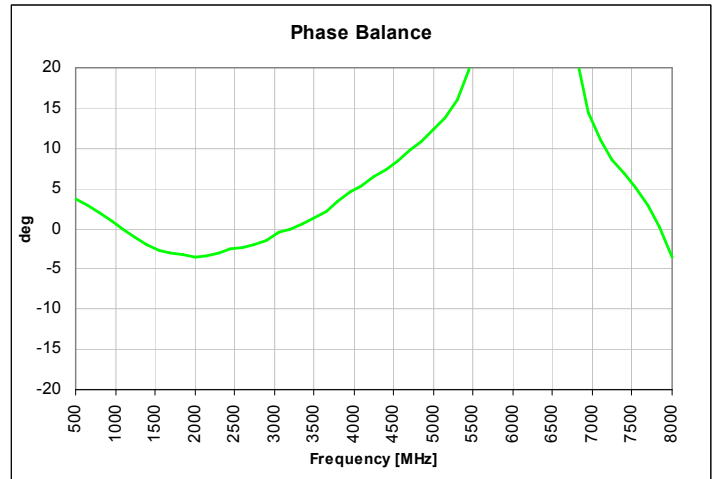
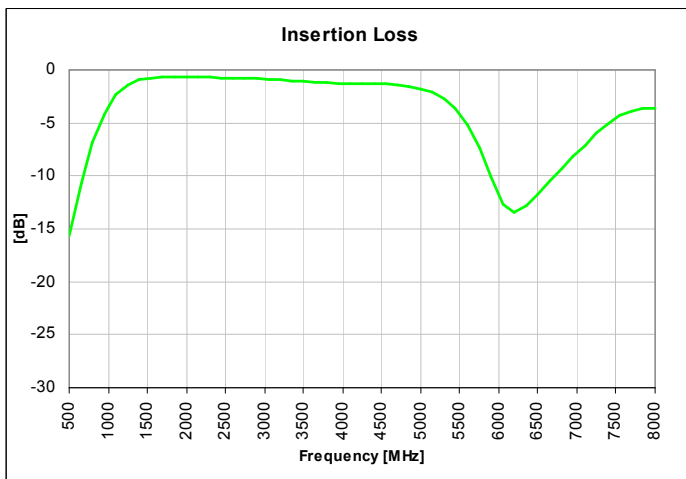
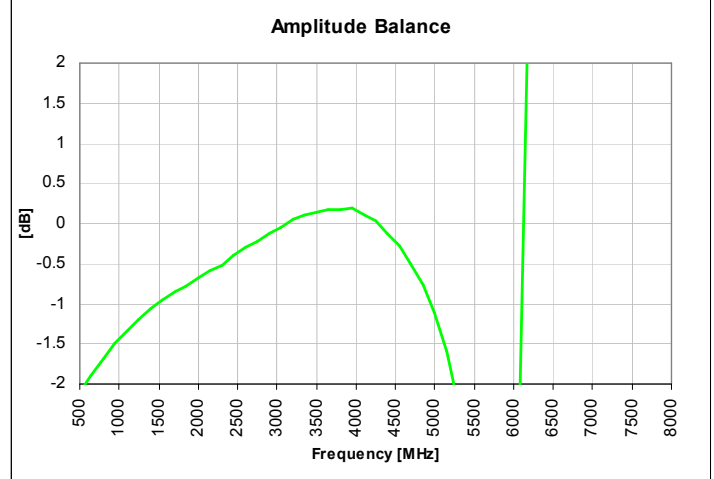
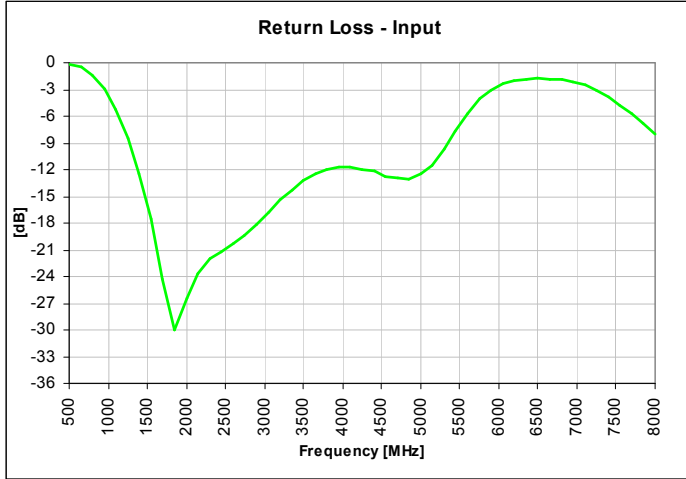

Typical Performance: 2200 MHz. to 2700 MHz.

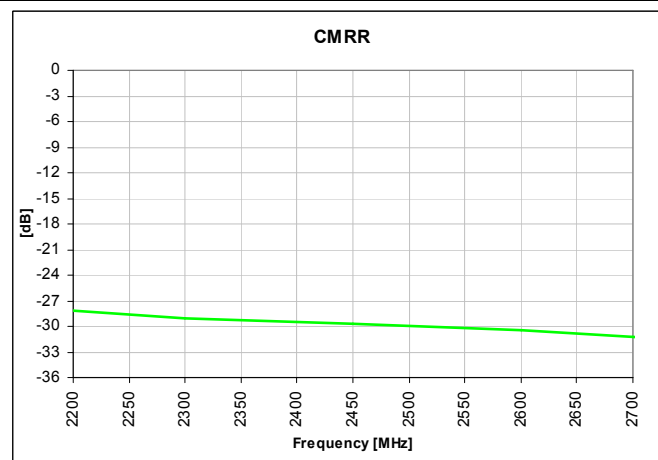
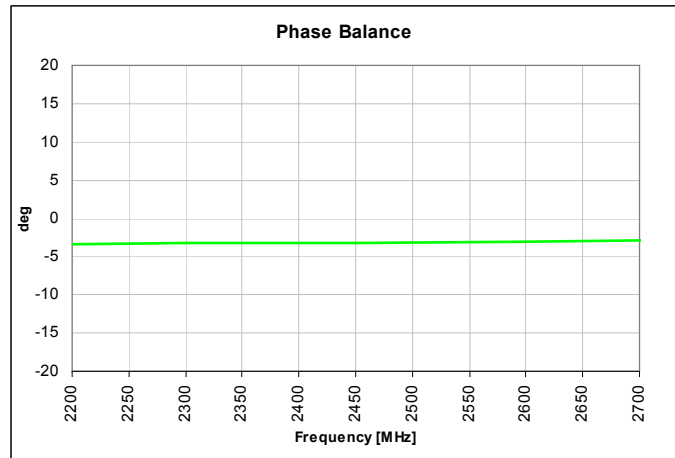
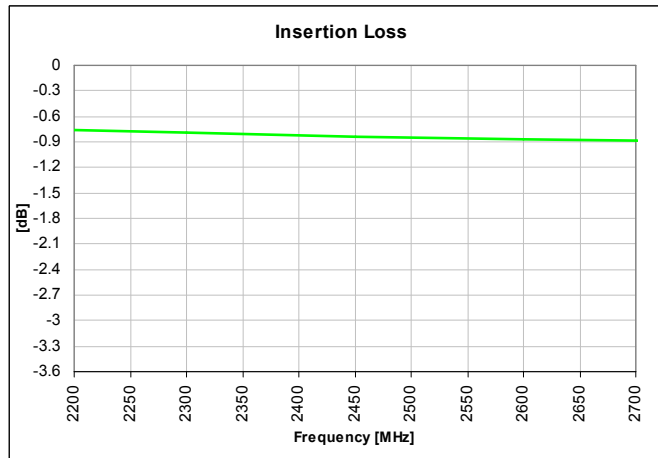
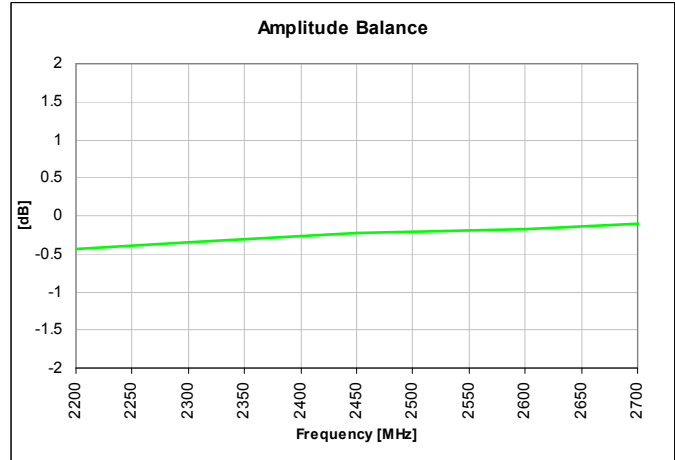
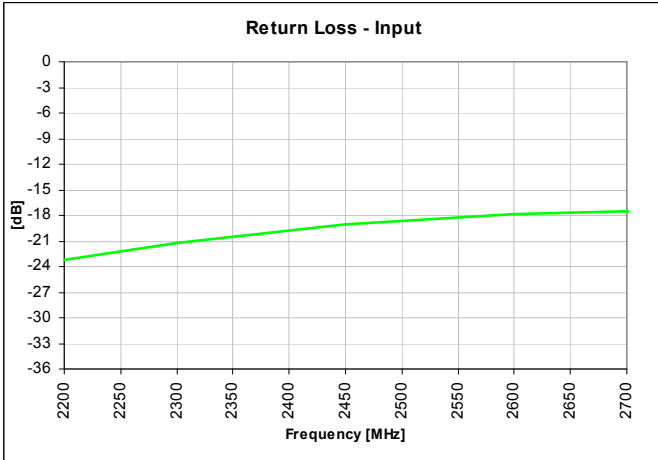

Mounting Configuration:

In order for Xinger surface mount components to work optimally, the proper impedance transmission lines must be used to connect to the RF ports. If this condition is not satisfied, insertion loss, Isolation and VSWR may not meet published specifications.

All of the Xinger components are constructed from organic PTFE based composites which possess excellent electrical and mechanical stability. Xinger components are compliant to a variety of ROHS and Green standards and ready for Pb-free soldering processes. Pads are Gold plated with a Nickel barrier.

An example of the PCB footprint used in the testing of these parts is shown below. In specific designs, the transmission line widths need to be adjusted to the unique dielectric coefficients and thicknesses as well as varying pick and place equipment tolerances.

No Bias Footprint

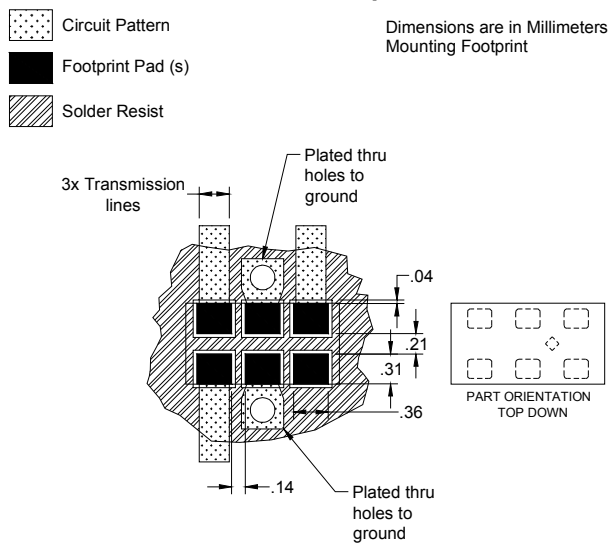

DC Bias Footprint

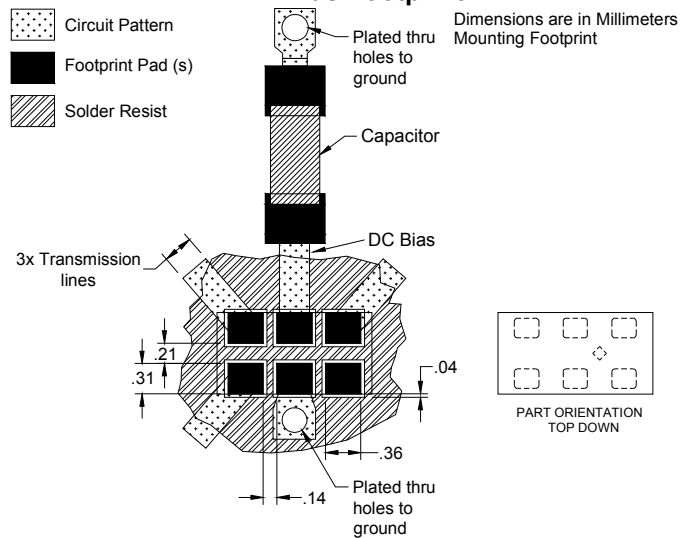

Packaging and Ordering Information

Parts are available in reel and are packaged per EIA 481-2. Parts are oriented in tape and reel as shown below. Minimum order quantities are 4000 per reel.

