

## Industrial 1-Port RS232/RS422/RS485 Serial Device Server



### Cost-effective Solution for RS232/422/485 Serial-to-Industrial Ethernet Application

PLANET ICS-210xT Serial Device Server series is specially designed to convert RS232, RS422 or RS485 serial communication to Industrial Fast Ethernet networking so as to extend the network distance efficiently and inexpensively. There are one 10/100BASE-TX RJ45 port and single-mode/multi-mode media available in the ICS-210xT series and its operating temperature ranges from -40 to 75 degrees C for your network needs. The ICS-210xT series is a time-saving and cost-effective solution for users and system integrators to quickly transform their serial devices into the Ethernet network with no need of replacing the existing serial devices and software system.



### Convert Serial Communication to IP Networking



### Efficiently Extend Network Distance (Only ICS-2105AT)

The ICS-2105AT especially equips one SFP fiber slot (mini-GBIC 100Base-FX SFP or small-form factor pluggable) and is able to extend the distance of deploying serial equipment and hosts. Users are able to select fiber-optic cables (based on distance) provided for distance extension from 550 meters (via multi-mode fiber) to 120 kilometers (via single-mode fiber) or longer.

### Serial Interface

- One DB9 interface that supports RS232
- One terminal block interface that supports 2-wire RS485 and 4-wire RS422/RS485 standards
- Asynchronous serial data rates up to 921600bps
- Data mode including VCOM, RFC2217, TCP Server, TCP Client, UDP, remote pair, Modbus converter server / client and serial telnet modes

### Ethernet Interface

- 1-port **10/100BASE-TX** RJ45 with auto MDI/MDI-X function or **100BASE-FX** SFP interface

### Management

- IPv4 and IPv6 dual stack management
- Remote management interfaces
  - IP-based Web management
  - Telnet console management
  - Windows-based VCOM utility supports searching, monitoring and configuration setting
- IP NTP (Network Time Protocol) and DNS management
- Standard TCP/IP interface and versatile operation modes
- Software Protocol supports ARP, ICMP, TCP/IP, UDP, HTTP server, DHCP client, Telnet server/client
- Serial Operation mode selected via management interface
- Pair Connection mode for connecting two serial devices over a network
- Allows a maximum of 4 hosts to be accessed as TCP client mode
- Firmware upgrade via HTTP protocol
- Accessible IP security control to prevent illegal users
- Event notification
  - Remote syslog server
  - SNMP trap
  - Relay output alarm
- DHCP client for IP address assignment
- PLANET Smart Discovery utility automatically finds the client devices on the network

**Remote Management**

As the ICS-210xT series provides easy serial-to-Ethernet connectivity and connection to a TCP/IP network, the remote network system can thus be managed efficiently via its Web, telnet, and VCOM management interfaces. It supports both application and serial operation modes for alarm or IP address connection, which saves the network administrator's time in detecting and locating network problems without visual inspection of the cabling and devices. Multiple connection options are available for a large networking environment as well.

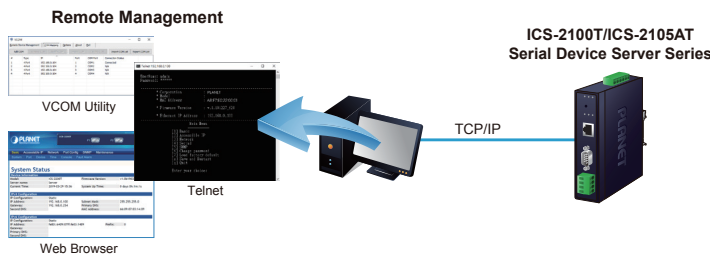

**Industrial Case and Installation**

- IP30 metal case
- DIN-rail and wall-mount designs
- Redundant power design
  - 9 to 48V DC or 24V AC, redundant power with reverse polarity protection
- Supports 6000 VDC Ethernet ESD protection
- -40 to 75 degrees C operating temperature
- Free fall, shock-proof and vibration-proof for industries
- Supports extensive LED indicators for network diagnosis
- Reset button for resetting to factory default

**Stable Performance under Difficult Environments**

The ICS-210xT series provides a high level of immunity against electromagnetic interference and heavy electrical surges which are usually found on plant floors or in curbside traffic control cabinets. Its operating temperature ranging from -40 to 75 degrees C allows the ICS-210xT series to be placed in almost any difficult environment.

The ICS-210xT series, equipped with compact IP30 standard metal case, allows either DIN-rail or wall mounting for efficient use of cabinet space. The ICS-210xT series also provides an integrated power supply source with a wide range of voltages (9 to 48V DC or 24V AC) ideally suitable for worldwide operation with high availability applications requiring dual or backup power inputs.

**Dual Power Input for High Availability Network System**

The ICS-210xT series features a strong dual power input system with wide-ranging voltages (9V~48V DC or 24V AC) incorporated into customer's automation network to enhance system reliability and uptime. In the example below, when Power Supply 1 fails to work, the hardware failover function will be activated automatically to keep powering the ICS-210xT series via Power Supply 2 without any break of operation.

**Non-stop Ethernet Service with Dual Power Input & Auto Failover**

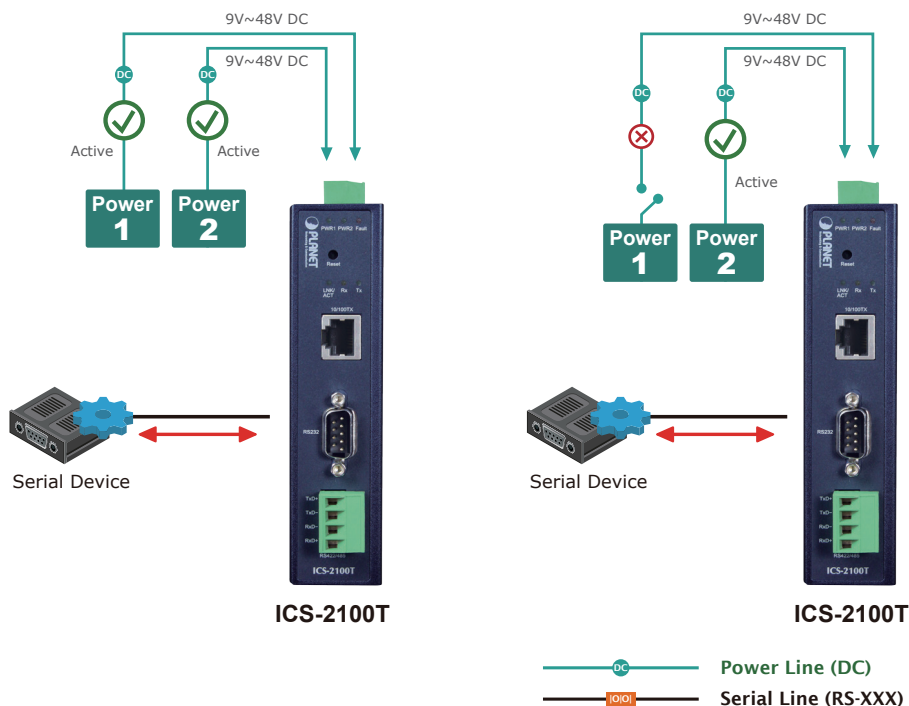

*Effective Alarm Alert for Better Protection*

The ICS-210xT series comes with a Fault Alarm feature which can alert the users when there is something wrong with the Serial Device Server. With this ideal feature, the users would not have to waste time finding where the problem is. It will help to save time and human resource. The ICS-210xT series provides event alert function to help to diagnose the abnormal device owing to whether or not there is a break of the network connection, or the rebooting response.

**Fault Alarm Feature**

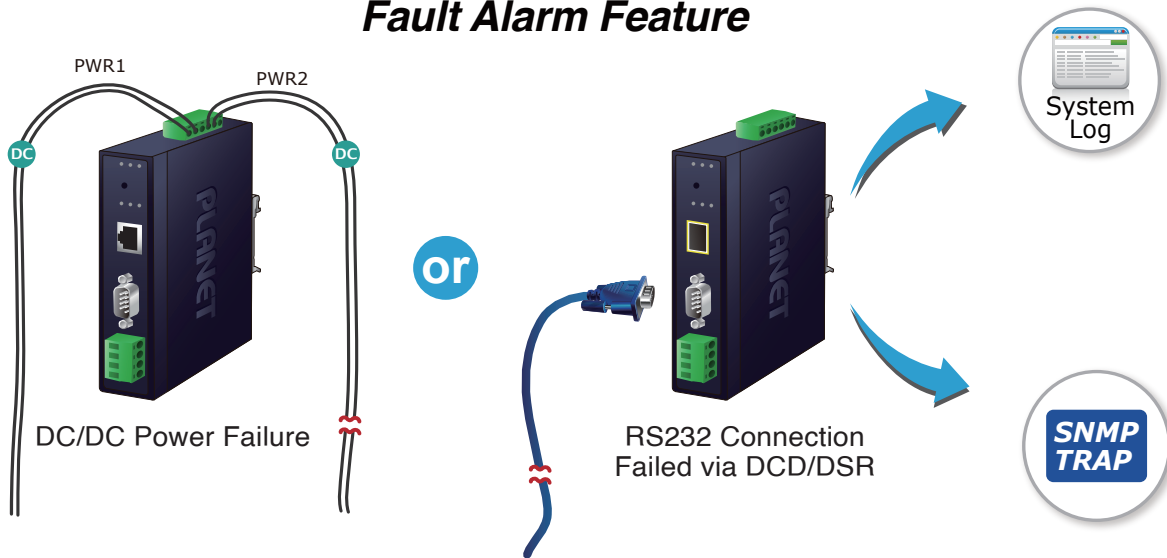

**Applications**

*Access Control System – Traditional System Application*

Most of the enterprises and government use access control plate and Mifare or RFID to authorize entrance identity. Traditionally, the access control machines use RS232 or RS485 serial interface with their cables connecting to login server. By applying the ICS-210xT Serial Device Server series, the access control machine is able to extend the network over longer distances via Ethernet interfaces. In addition, the ICS-210xT series can be linked to an xDSL router to get the internet access capability so that the access control can be set and monitored over the internet.

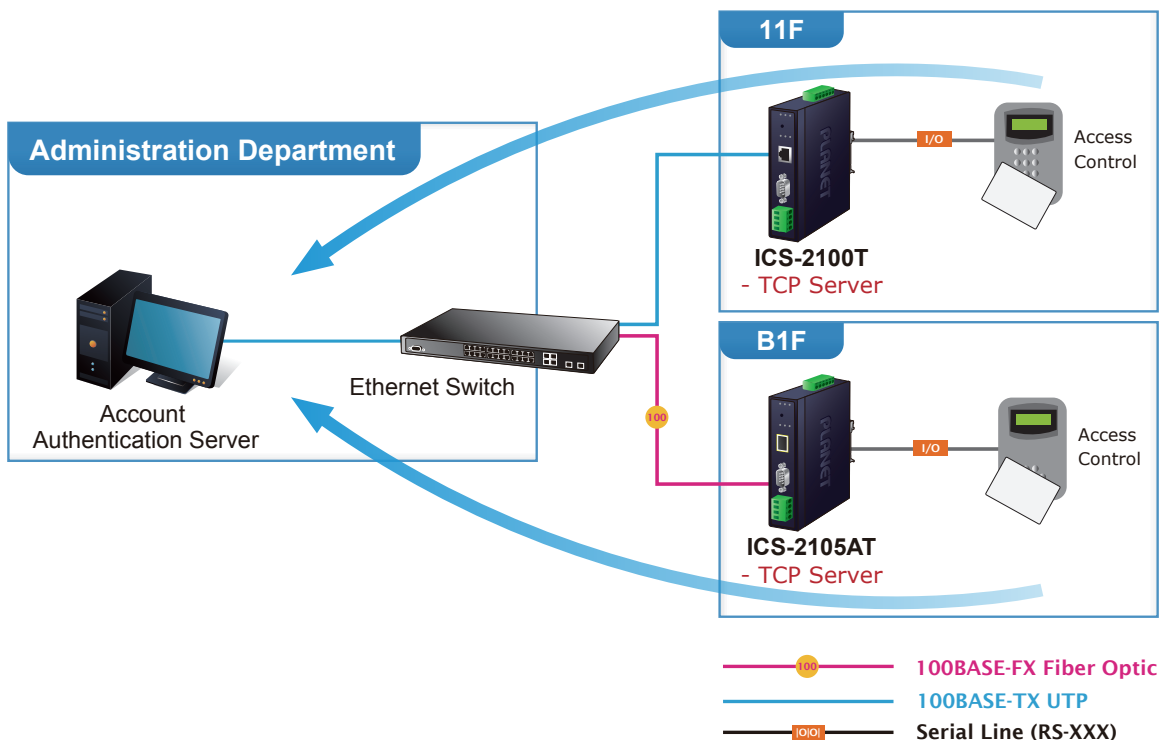

**Process Control**

To monitor, configure and manage the robotic conveyer including other production machines, PLC (Programmable Logical Control) is required to drive the above manufacturing process. The ICS-210xT series can be set to the TCP Server mode and connected to the PLC. Thus, the administrator can configure and set command settings through Fast Ethernet intranet to remotely control the PLC, without having to stand by the I/O machine.

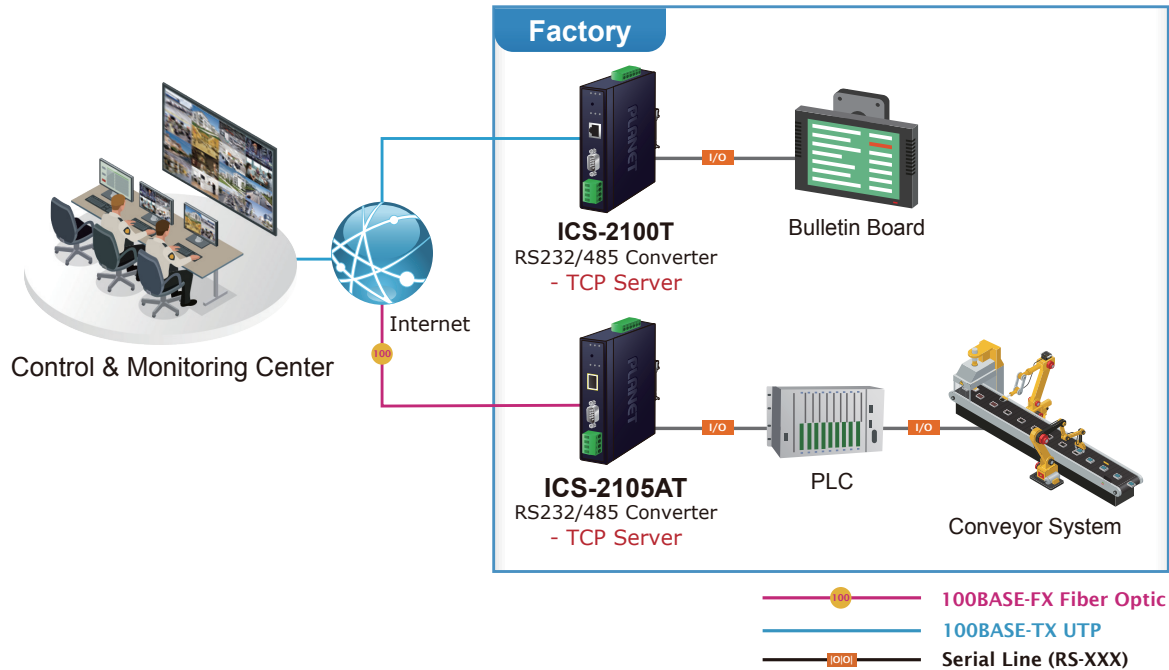

**Surveillance Motion Control – Pair Connection Mode**

Using pair connection mode via the fiber optic patch cord, the ICS-210xT series can extend the distance of the deployed devices via RS232, RS422 and RS485 interfaces, making the remote management of these devices from the monitoring center easier and efficient.

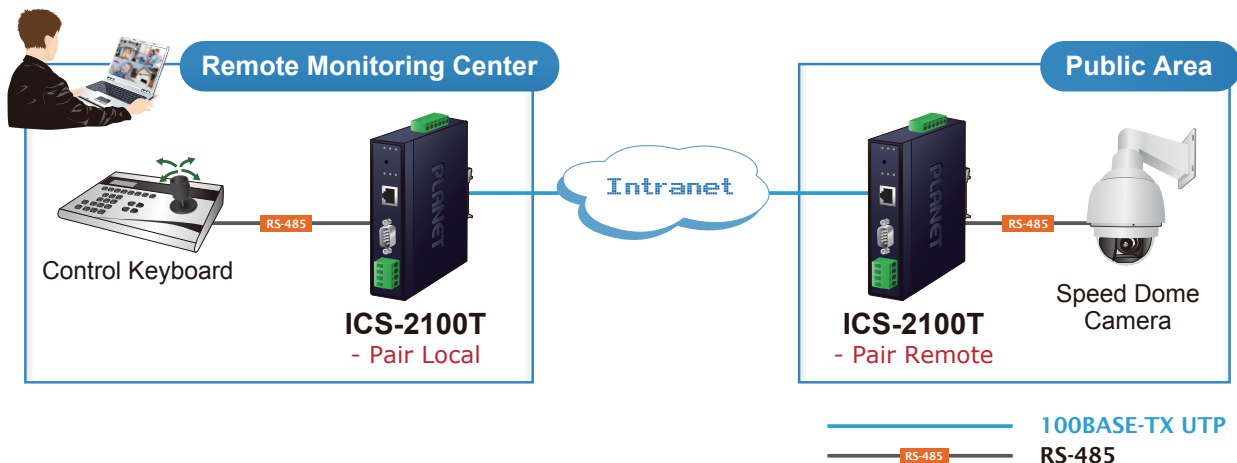

## Drawing

### ■ ICS-2100T

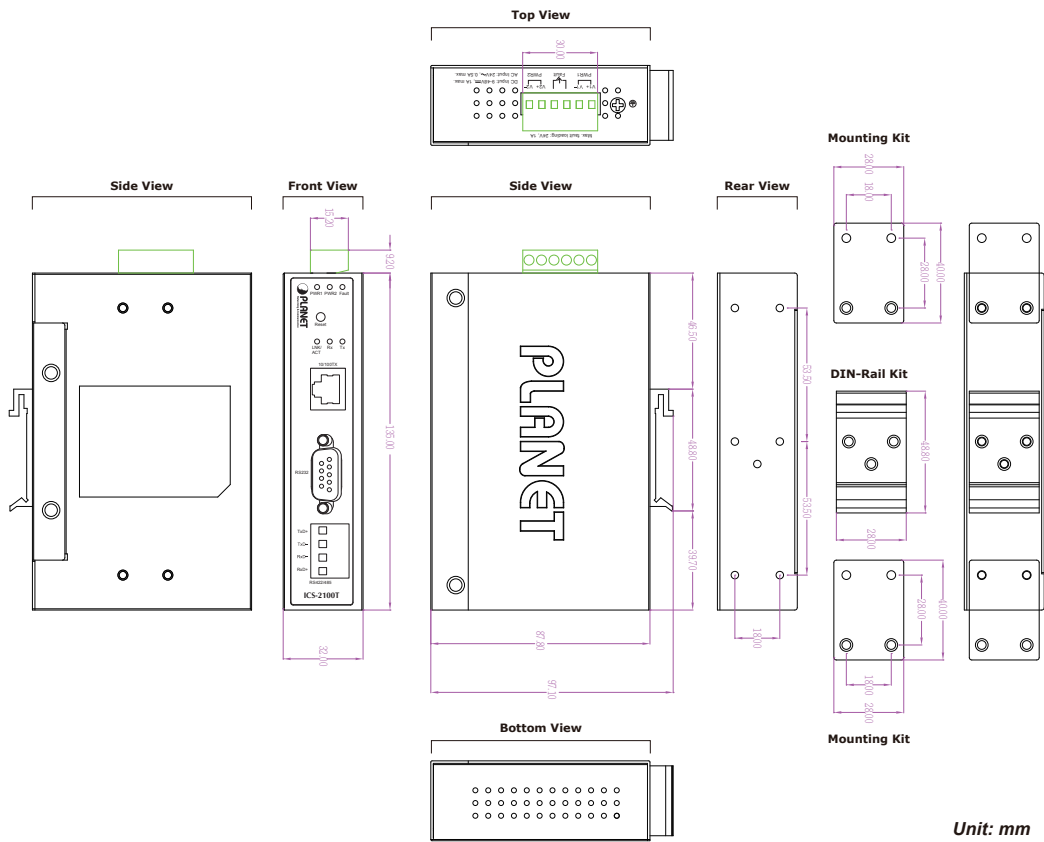

### ■ ICS-2105AT

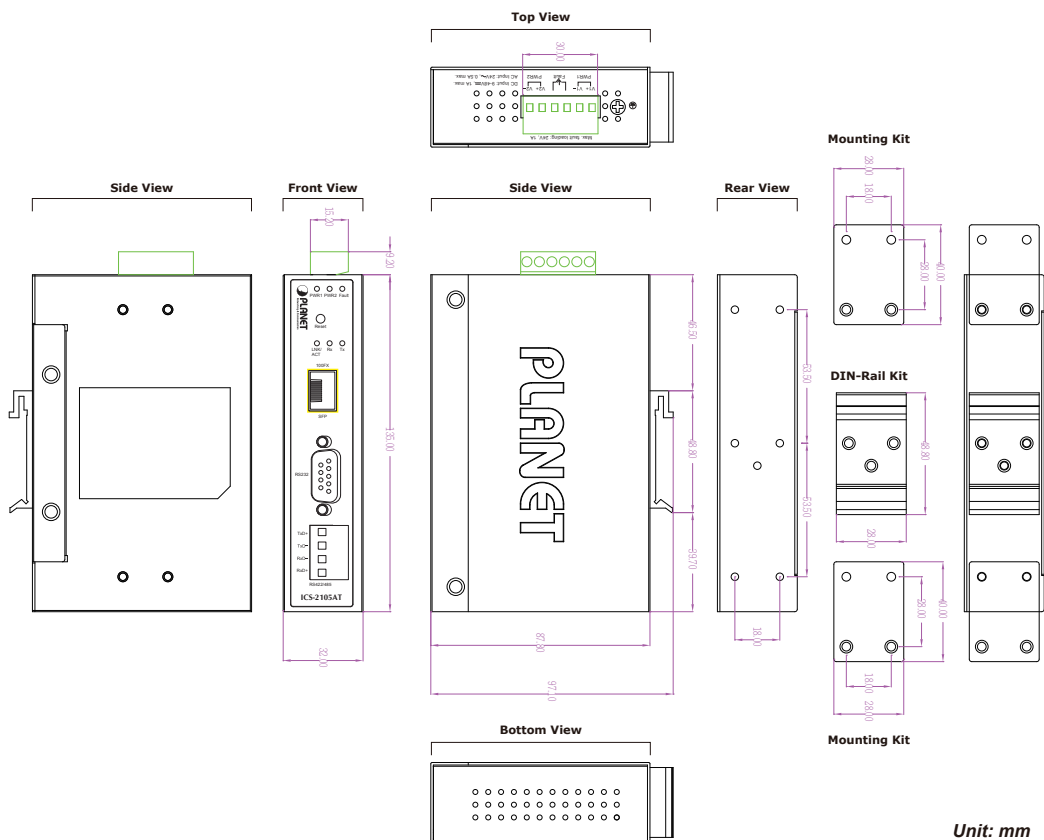

## Specifications

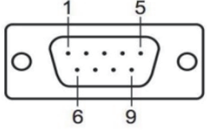
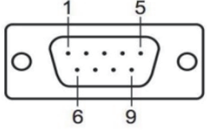
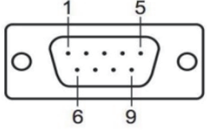
| Product  | ICS-2100T  | ICS-2105AT   |                   |          |       |                   |          |  |   |     |      |    |   |     |      |    |   |     |      |       |   |     |      |       |   |     |     |     |   |     |    |    |   |     |    |    |   |     |    |    |   |    |    |    |
|--|--|--|-------------------|----------|-------|-------------------|----------|--|---|-----|------|----|---|-----|------|----|---|-----|------|-------|---|-----|------|-------|---|-----|-----|-----|---|-----|----|----|---|-----|----|----|---|-----|----|----|---|----|----|----|
| <b>Serial Interface</b>  |  |  |                   |          |       |                   |          |  |   |     |      |    |   |     |      |    |   |     |      |       |   |     |      |       |   |     |     |     |   |     |    |    |   |     |    |    |   |     |    |    |   |    |    |    |
| Serial Ports   | 1 x DB9 male for RS232<br>1 x 4-Pin Terminal block for RS422 / RS485   |  |                   |          |       |                   |          |  |   |     |      |    |   |     |      |    |   |     |      |       |   |     |      |       |   |     |     |     |   |     |    |    |   |     |    |    |   |     |    |    |   |    |    |    |
| Serial Standards   | RS232 / 4-wire RS422 or RS485 / 2-wire RS485   |  |                   |          |       |                   |          |  |   |     |      |    |   |     |      |    |   |     |      |       |   |     |      |       |   |     |     |     |   |     |    |    |   |     |    |    |   |     |    |    |   |    |    |    |
| Baud Rate (Data Rate)  | 50bps to 921Kbps   |  |                   |          |       |                   |          |  |   |     |      |    |   |     |      |    |   |     |      |       |   |     |      |       |   |     |     |     |   |     |    |    |   |     |    |    |   |     |    |    |   |    |    |    |
| Data Bits  | 5, 6, 7, 8   |  |                   |          |       |                   |          |  |   |     |      |    |   |     |      |    |   |     |      |       |   |     |      |       |   |     |     |     |   |     |    |    |   |     |    |    |   |     |    |    |   |    |    |    |
| Parity Type  | 1, 1.5, 2  |  |                   |          |       |                   |          |  |   |     |      |    |   |     |      |    |   |     |      |       |   |     |      |       |   |     |     |     |   |     |    |    |   |     |    |    |   |     |    |    |   |    |    |    |
| Stop Bit   | Odd, Even, None, Space, Mark   |  |                   |          |       |                   |          |  |   |     |      |    |   |     |      |    |   |     |      |       |   |     |      |       |   |     |     |     |   |     |    |    |   |     |    |    |   |     |    |    |   |    |    |    |
| Flow Control   | RTS/CTS and DTR/DSR (RS232 only)<br>XON/XOFF   |  |                   |          |       |                   |          |  |   |     |      |    |   |     |      |    |   |     |      |       |   |     |      |       |   |     |     |     |   |     |    |    |   |     |    |    |   |     |    |    |   |    |    |    |
| Signals  | RS232: TxD, RxD, RTS, CTS, DTR, DSR, DCD, GND<br>RS422: Tx+, Tx-, Rx+, Rx-, GND<br>4-wire RS485: Tx+, Tx-, Rx+, Rx-, GND<br>2-wire RS485: Data A (+), Data B (-), GND  |  |                   |          |       |                   |          |  |   |     |      |    |   |     |      |    |   |     |      |       |   |     |      |       |   |     |     |     |   |     |    |    |   |     |    |    |   |     |    |    |   |    |    |    |
| Pin Assignment   | <table border="1"> <thead> <tr> <th>Male DB9</th> <th>Pin</th> <th>RS232</th> <th>RS422<br/>RS485-4W</th> <th>RS485-2W</th> </tr> </thead> <tbody> <tr> <td rowspan="9">  </td> <td>1</td> <td>DCD</td> <td>TxD+</td> <td>--</td> </tr> <tr> <td>2</td> <td>RxD</td> <td>TxD-</td> <td>--</td> </tr> <tr> <td>3</td> <td>TxD</td> <td>RxD-</td> <td>Data-</td> </tr> <tr> <td>4</td> <td>DTR</td> <td>RxD+</td> <td>Data+</td> </tr> <tr> <td>5</td> <td>GND</td> <td>GND</td> <td>GND</td> </tr> <tr> <td>6</td> <td>DSR</td> <td>--</td> <td>--</td> </tr> <tr> <td>7</td> <td>RTS</td> <td>--</td> <td>--</td> </tr> <tr> <td>8</td> <td>CTS</td> <td>--</td> <td>--</td> </tr> <tr> <td>9</td> <td>--</td> <td>--</td> <td>--</td> </tr> </tbody> </table> |  | Male DB9          | Pin      | RS232 | RS422<br>RS485-4W | RS485-2W |  | 1 | DCD | TxD+ | -- | 2 | RxD | TxD- | -- | 3 | TxD | RxD- | Data- | 4 | DTR | RxD+ | Data+ | 5 | GND | GND | GND | 6 | DSR | -- | -- | 7 | RTS | -- | -- | 8 | CTS | -- | -- | 9 | -- | -- | -- |
| Male DB9   | Pin  | RS232  | RS422<br>RS485-4W | RS485-2W |       |                   |          |  |   |     |      |    |   |     |      |    |   |     |      |       |   |     |      |       |   |     |     |     |   |     |    |    |   |     |    |    |   |     |    |    |   |    |    |    |
|  | 1  | DCD  | TxD+              | --       |       |                   |          |  |   |     |      |    |   |     |      |    |   |     |      |       |   |     |      |       |   |     |     |     |   |     |    |    |   |     |    |    |   |     |    |    |   |    |    |    |
|  | 2  | RxD  | TxD-              | --       |       |                   |          |  |   |     |      |    |   |     |      |    |   |     |      |       |   |     |      |       |   |     |     |     |   |     |    |    |   |     |    |    |   |     |    |    |   |    |    |    |
|  | 3  | TxD  | RxD-              | Data-    |       |                   |          |  |   |     |      |    |   |     |      |    |   |     |      |       |   |     |      |       |   |     |     |     |   |     |    |    |   |     |    |    |   |     |    |    |   |    |    |    |
|  | 4  | DTR  | RxD+              | Data+    |       |                   |          |  |   |     |      |    |   |     |      |    |   |     |      |       |   |     |      |       |   |     |     |     |   |     |    |    |   |     |    |    |   |     |    |    |   |    |    |    |
|  | 5  | GND  | GND               | GND      |       |                   |          |  |   |     |      |    |   |     |      |    |   |     |      |       |   |     |      |       |   |     |     |     |   |     |    |    |   |     |    |    |   |     |    |    |   |    |    |    |
|  | 6  | DSR  | --                | --       |       |                   |          |  |   |     |      |    |   |     |      |    |   |     |      |       |   |     |      |       |   |     |     |     |   |     |    |    |   |     |    |    |   |     |    |    |   |    |    |    |
|  | 7  | RTS  | --                | --       |       |                   |          |  |   |     |      |    |   |     |      |    |   |     |      |       |   |     |      |       |   |     |     |     |   |     |    |    |   |     |    |    |   |     |    |    |   |    |    |    |
|  | 8  | CTS  | --                | --       |       |                   |          |  |   |     |      |    |   |     |      |    |   |     |      |       |   |     |      |       |   |     |     |     |   |     |    |    |   |     |    |    |   |     |    |    |   |    |    |    |
|  | 9  | --   | --                | --       |       |                   |          |  |   |     |      |    |   |     |      |    |   |     |      |       |   |     |      |       |   |     |     |     |   |     |    |    |   |     |    |    |   |     |    |    |   |    |    |    |
| <b>Ethernet Interface</b>  |  |  |                   |          |       |                   |          |  |   |     |      |    |   |     |      |    |   |     |      |       |   |     |      |       |   |     |     |     |   |     |    |    |   |     |    |    |   |     |    |    |   |    |    |    |
| Ethernet Ports   | 1 x RJ45   | 1 x SFP  |                   |          |       |                   |          |  |   |     |      |    |   |     |      |    |   |     |      |       |   |     |      |       |   |     |     |     |   |     |    |    |   |     |    |    |   |     |    |    |   |    |    |    |
| Standard   | 10/100BASE-TX  | 100BASE-FX   |                   |          |       |                   |          |  |   |     |      |    |   |     |      |    |   |     |      |       |   |     |      |       |   |     |     |     |   |     |    |    |   |     |    |    |   |     |    |    |   |    |    |    |
| Distance   | 100m   | 2km to 120km, vary on SFP modules  |                   |          |       |                   |          |  |   |     |      |    |   |     |      |    |   |     |      |       |   |     |      |       |   |     |     |     |   |     |    |    |   |     |    |    |   |     |    |    |   |    |    |    |
| ESD Protection   | 6KV  |  |                   |          |       |                   |          |  |   |     |      |    |   |     |      |    |   |     |      |       |   |     |      |       |   |     |     |     |   |     |    |    |   |     |    |    |   |     |    |    |   |    |    |    |
| Surge Protection   | 2KV  |  |                   |          |       |                   |          |  |   |     |      |    |   |     |      |    |   |     |      |       |   |     |      |       |   |     |     |     |   |     |    |    |   |     |    |    |   |     |    |    |   |    |    |    |
| <b>Hardware</b>  |  |  |                   |          |       |                   |          |  |   |     |      |    |   |     |      |    |   |     |      |       |   |     |      |       |   |     |     |     |   |     |    |    |   |     |    |    |   |     |    |    |   |    |    |    |
| Installation   | DIN-rail kit and wall-mount ear  |  |                   |          |       |                   |          |  |   |     |      |    |   |     |      |    |   |     |      |       |   |     |      |       |   |     |     |     |   |     |    |    |   |     |    |    |   |     |    |    |   |    |    |    |
| Enclosure  | IP 30 metal  |  |                   |          |       |                   |          |  |   |     |      |    |   |     |      |    |   |     |      |       |   |     |      |       |   |     |     |     |   |     |    |    |   |     |    |    |   |     |    |    |   |    |    |    |
| Dimensions (W x D x H)   | 32 x 87.8 x 135 mm   | 32 x 87.8 x 135 mm   |                   |          |       |                   |          |  |   |     |      |    |   |     |      |    |   |     |      |       |   |     |      |       |   |     |     |     |   |     |    |    |   |     |    |    |   |     |    |    |   |    |    |    |
| Weight   | 392g   | 390g   |                   |          |       |                   |          |  |   |     |      |    |   |     |      |    |   |     |      |       |   |     |      |       |   |     |     |     |   |     |    |    |   |     |    |    |   |     |    |    |   |    |    |    |
| LED Indicators   | System: Power 1, Power 2, Fault, SYS<br>TP/SFP Port: Link/ Active<br>Serial Port: Tx and Rx  |  |                   |          |       |                   |          |  |   |     |      |    |   |     |      |    |   |     |      |       |   |     |      |       |   |     |     |     |   |     |    |    |   |     |    |    |   |     |    |    |   |    |    |    |
| Power Requirements   | 9~48V DC or 24V AC, redundant power with reverse polarity protection   |  |                   |          |       |                   |          |  |   |     |      |    |   |     |      |    |   |     |      |       |   |     |      |       |   |     |     |     |   |     |    |    |   |     |    |    |   |     |    |    |   |    |    |    |
| Power Consumption  | Full Loading<br>9VDC: 0.35A (3.15 watts)<br>12VDC: 0.28A (3.36 watts)<br>24VDC: 0.12A (3 watts)<br>48VDC: 0.08A (3.84 watts)   | Full Loading<br>9VDC: 0.44A (3.96 watts)<br>12VDC: 0.33A (4 watts)<br>24VDC: 0.17A (4.08 watts)<br>48VDC: 0.1A (4.8 watts) |                   |          |       |                   |          |  |   |     |      |    |   |     |      |    |   |     |      |       |   |     |      |       |   |     |     |     |   |     |    |    |   |     |    |    |   |     |    |    |   |    |    |    |
| Connector  | Removable 6-pin terminal block for power input<br>Pin 1/2 for Power 1, Pin 3/4 for fault alarm, Pin 5/6 for Power 2  |  |                   |          |       |                   |          |  |   |     |      |    |   |     |      |    |   |     |      |       |   |     |      |       |   |     |     |     |   |     |    |    |   |     |    |    |   |     |    |    |   |    |    |    |
| Alarm  | Provides one relay output for power failure<br>Alarm relay current carry ability: 1A @ DC 24V  |  |                   |          |       |                   |          |  |   |     |      |    |   |     |      |    |   |     |      |       |   |     |      |       |   |     |     |     |   |     |    |    |   |     |    |    |   |     |    |    |   |    |    |    |
| Reset Button   | < 5 sec: System reboot<br>> 5 sec: Factory default   |  |                   |          |       |                   |          |  |   |     |      |    |   |     |      |    |   |     |      |       |   |     |      |       |   |     |     |     |   |     |    |    |   |     |    |    |   |     |    |    |   |    |    |    |
| <b>Management</b>  |  |  |                   |          |       |                   |          |  |   |     |      |    |   |     |      |    |   |     |      |       |   |     |      |       |   |     |     |     |   |     |    |    |   |     |    |    |   |     |    |    |   |    |    |    |
| Management Interfaces  | Web management<br>Telnet Console management<br>Windows-based VCOM Utility management<br>SNMPv1, v2c / SNMP Trap<br>UNI-NMS monitoring<br>PLANET Smart Discovery Utility  |  |                   |          |       |                   |          |  |   |     |      |    |   |     |      |    |   |     |      |       |   |     |      |       |   |     |     |     |   |     |    |    |   |     |    |    |   |     |    |    |   |    |    |    |
| IP Version   | IPv4 and IPv6  |  |                   |          |       |                   |          |  |   |     |      |    |   |     |      |    |   |     |      |       |   |     |      |       |   |     |     |     |   |     |    |    |   |     |    |    |   |     |    |    |   |    |    |    |

|                                       |   |
|---------------------------------------|---|
| Operation Mode                        | TCP Server<br>TCP Client<br>UDP Client<br>Virtual COM<br>RFC2217<br>Telnet Server<br>Pair Connection – Remote (Slave)<br>Pair Connection – Local (Master)<br>Modbus converter server / client   |
| Virtual COM Utility Platform Supports | Windows-based only:<br>Windows XP<br>Windows Server 2003<br>Windows 7<br>Windows Server 2008<br>Windows 8 (Must install the latest version of WinPcap)<br>Windows Server 2012 (Must install the latest version of WinPcap)<br>Windows 10  |
| Security                              | Allow max. 4 accessible IP address hosts/ranges   |
| SNMP MIBs                             | RFC1213 MIB-II<br>RFC1317 RS232-like MIB  |
| <b>Standards Conformances</b>         |   |
| Regulatory Compliance                 | FCC Part 15 Class A,<br>CE Certification Class A  |
| Stability Testing                     | IEC60068-2-32 (Free fall)<br>IEC60068-2-27 (Shock)<br>IEC60068-2-6 (Vibration)  |
| Standards                             | IEEE 802.3 10BASE-T<br>IEEE 802.3u 100BASE-TX/100BASE-FX<br>RFC 768 UDP<br>RFC 793 TFTP<br>RFC 791 IP<br>RFC 792 ICMP<br>RFC 854 Telnet<br>RFC 958 NTP<br>RFC 1591 DNS (client only)<br>RFC 1908 SNMPv2c<br>RFC 2068 HTTP<br>RFC 2131 DHCP Client<br>RFC 2732 Format for Literal IPv6 Addresses in URL's<br>RFC 3315 DHCPv6 Client<br>RFC 3513 IPv6 Addressing Architecture<br>RFC 3596 DNSv6<br>RFC 4443 ICMPv6<br>EIA/TIA RS232/422/485 |
| Regulatory Approval                   | RoHS  |
| <b>Environment</b>                    |   |
| Operating Temperature                 | -40 ~ 75 degrees C  |
| Storage Temperature                   | -40 ~ 85 degrees C  |
| Humidity                              | 5 ~ 95% (non-condensing)  |

## Ordering Information

|            |   |
|------------|---|
| ICS-2100T  | IP30 Industrial 1-Port RS232/RS422/RS485 Serial Device Server (1 x 10/100TX, -40~75 degrees C)              |
| ICS-2105AT | IP30 Industrial 1-Port RS232/RS422/RS485 Serial Device Server with 1-Port 100BASE-FX SFP (-40~75 degrees C) |

## Related Products

|           |   |
|-----------|---|
| ICS-2200T | IP30 Industrial 2-Port RS232/RS422/RS485 Serial Device Server<br>(2 x 10/100TX, -40~75 degrees C, 2KV isolation)              |
| ICS-2400T | IP40 Industrial 4-Port RS232/RS422/RS485 Serial Device Server<br>(2 x 10/100TX, -40~75 degrees C, 2KV isolation, 2xDI + 2xDO) |
| ICS-2100  | Industrial RS-232/RS-422/RS-485 over 10/100BASE-TX Media Converter (Copper, RJ-45)  |
| ICS-2105A | Industrial RS-232/RS-422/RS-485 over 100BASE-FX SFP Media Converter   |

### PLANET Technology Corporation

11F., No.96, Minquan Rd., Xindian Dist., New Taipei City 231,  
Taiwan (R.O.C.)

Tel: 886-2-2219-9518

Email: sales@planet.com.tw

Fax: 886-2-2219-9528

www.planet.com.tw



PLANET reserves the right to change specifications without prior notice. All brand names and trademarks are property of their respective owners. Copyright © 2020 PLANET Technology Corp. All rights reserved.

ICS-2100T/ ICS-2105AT