

Photomicrosensor (Transmissive) EE-SX4134



⚠ Be sure to read Precautions on page 24.

■ Dimensions

Note: All units are in millimeters unless otherwise indicated.

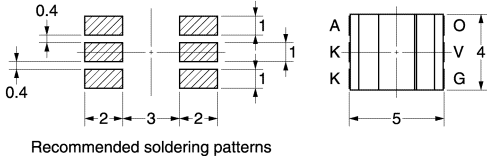

Recommended soldering patterns

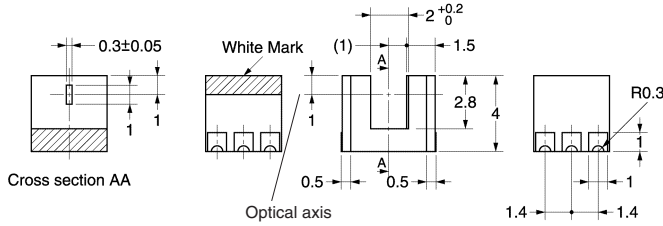

Cross section AA

Optical axis

Internal Circuit

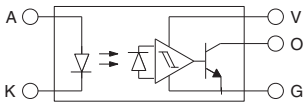

Unless otherwise specified, the tolerances are ± 0.15 mm.

Terminal No.	Name
A	Anode
K	Cathode
V	Supply voltage (V _{CC})
O	Output (OUT)
G	Ground (GND)

■ Features

- Ultra-compact model.
- Photo IC output model.
- Operates at a V_{CC} of 2.2 to 7 V.
- PCB surface mounting type.

■ Absolute Maximum Ratings (Ta = 25°C)

	Item	Symbol	Rated value
Emitter	Forward current	I _F	25 mA (see note 1)
	Reverse voltage	V _R	5 V
Detector	Supply voltage	V _{CC}	9 V
	Output voltage	V _{OUT}	17 V
	Output current	I _{OUT}	8 mA
	Permissible output dissipation	P _{OUT}	80 mW (see note 1)
Ambient temperature	Operating	T _{opr}	-25°C to 85°C
	Storage	T _{stg}	-40°C to 90°C
	Reflow soldering	T _{sol}	255°C (see note 2)
	Manual soldering	T _{sol}	350°C (see note 2)

- Note:** 1. Refer to the temperature rating chart if the ambient temperature exceeds 25°C.
 2. Complete soldering within 10 seconds for reflow soldering and within 3 seconds for manual soldering.

■ Electrical and Optical Characteristics (Ta = 25°C)

	Item	Symbol	Value	Condition
Emitter	Forward voltage	V _F	1.2 V typ., 1.4 V max.	I _F = 20 mA
	Reverse current	I _R	0.01 μA typ., 10 μA max.	V _R = 5 V
	Peak emission wavelength	λ _p	940 nm typ.	I _F = 20 mA
Detector	Power supply voltage	V _{CC}	2.2 V min., 7 V max.	---
	Low-level output voltage	V _{OL}	0.12 V typ., 0.4 V max.	V _{CC} = 2.2 to 7 V, I _{OL} = 8 mA, I _F = 7 mA
	High-level output current	I _{OH}	10 μA max.	V _{CC} = 2.2 to 7 V, I _F = 0 mA, V _{OUT} = 17 V
	Current consumption	I _{CC}	2.8 mA typ., 4 mA max.	V _{CC} = 7 V
	Peak spectral sensitivity wavelength	λ _p	870 nm typ.	V _{CC} = 2.2 to 7 V
LED current when output is ON		I _{FT}	2.0 mA typ., 3.5 mA max.	V _{CC} = 2.2 to 7 V
Hysteresis		ΔH	21% typ.	V _{CC} = 2.2 to 7 V (see note 1)
Response frequency		f	3 kHz min.	V _{CC} = 2.2 to 7 V, I _F = 5 mA, I _{OL} = 8 mA (see note 2)
Response delay time		t _{PHL}	7 μs typ.	V _{CC} = 2.2 to 7 V, I _F = 5 mA, I _{OL} = 8 mA (see note 3)
Response delay time		t _{PLH}	18 μs typ.	V _{CC} = 2.2 to 7 V, I _F = 5 mA, I _{OL} = 8 mA (see note 3)

- Note:** 1. Hysteresis denotes the difference in forward LED current value, expressed in percentage, calculated from the respective forward LED currents when the photo IC is turned from ON to OFF and when the photo IC is turned from OFF to ON.
2. The value of the response frequency is measured by rotating the disk as shown below.

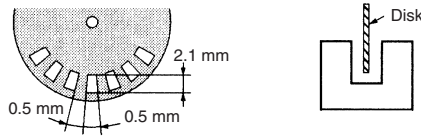

3. The following illustrations show the definition of response delay time.

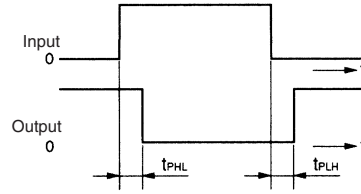

Engineering Data

Forward Current vs. Collector Dissipation Temperature Rating

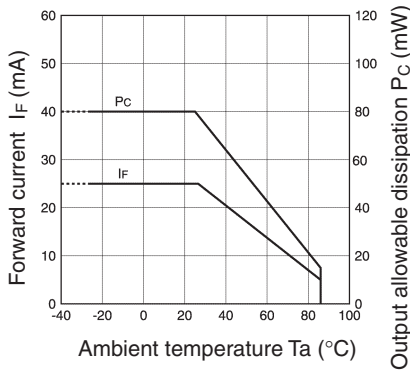

Forward Current vs. Forward Voltage Characteristics (Typical)

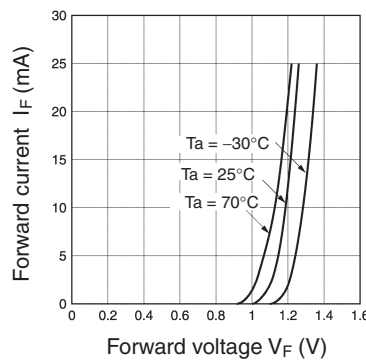

LED Current vs. Supply Voltage (Typical)

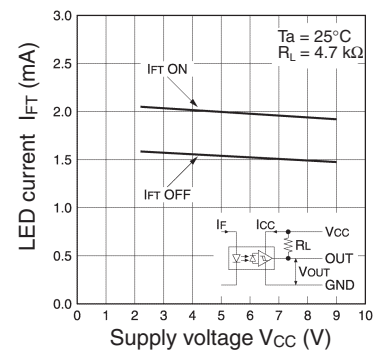

LED Current vs. Ambient Temperature Characteristics (Typical)

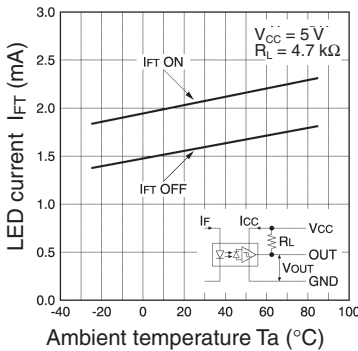

Low-level Output Voltage vs. Output Current (Typical)

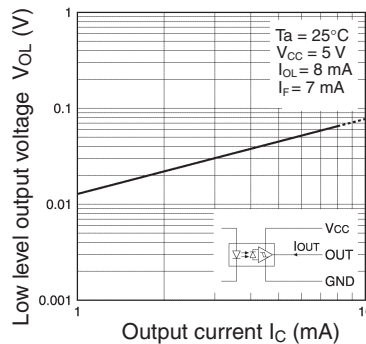

Low-level Output Voltage vs. Ambient Temperature Characteristics (Typical)

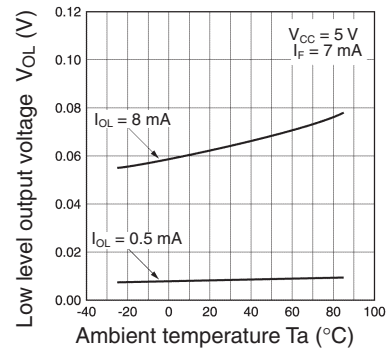

Current Consumption vs. Supply Voltage (Typical)

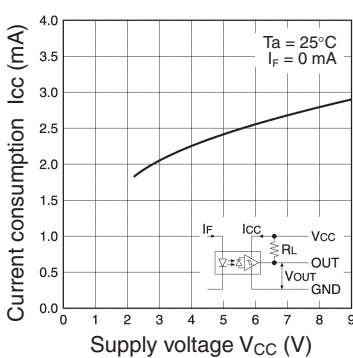

Response Delay Time vs. Forward Current (Typical)

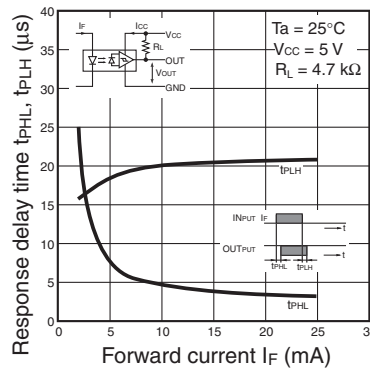

Repeat Sensing Position Characteristics (Typical)

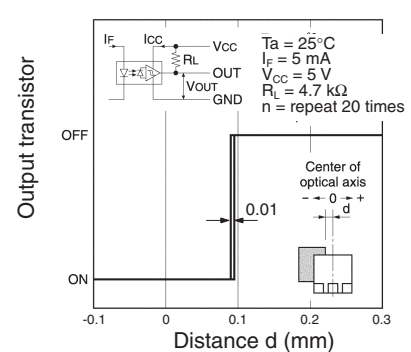

This announcement is based on product catalogue information previously shown before its discontinuation
 Product information of the existing product may be different from the previous version

Unit: mm (inch)

■ Tape and Reel

Reel

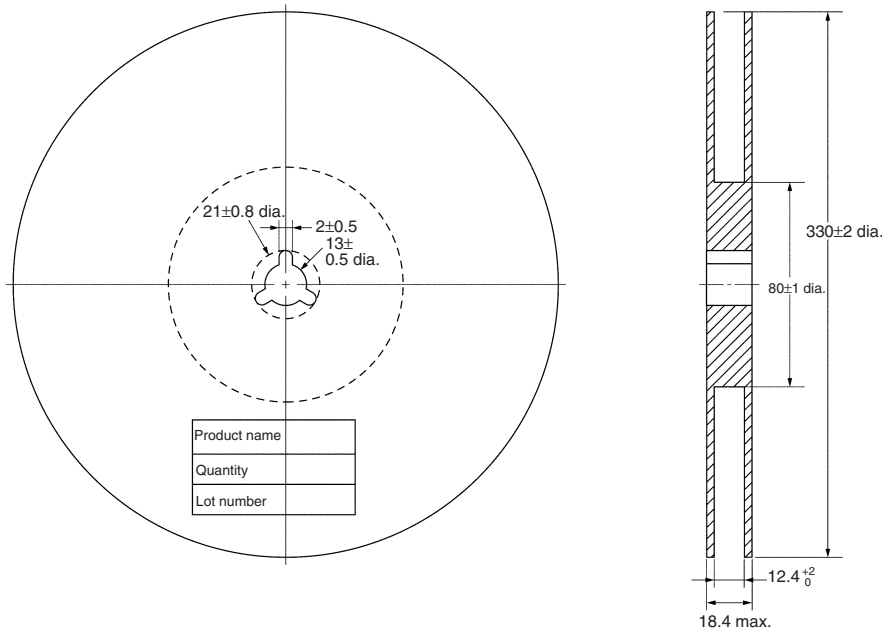

Tape

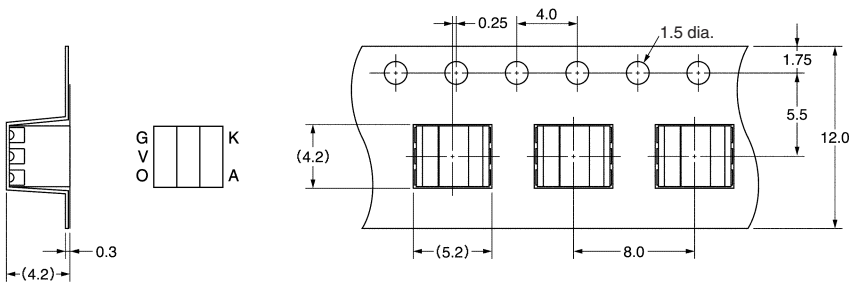

Tape configuration

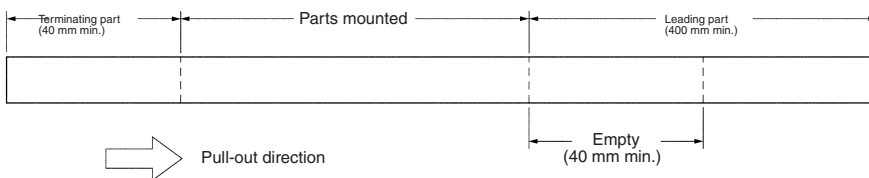

Tape quantity

2,000 pcs./reel

Precautions

■ Soldering Information

Reflow soldering

- The following soldering paste is recommended:
Melting temperature: 216 to 220°C
Composition: Sn 3.5 Ag 0.75 Cu
- The recommended thickness of the metal mask for screen printing is between 0.2 and 0.25 mm.
- Set the reflow oven so that the temperature profile shown in the following chart is obtained for the upper surface of the product being soldered.

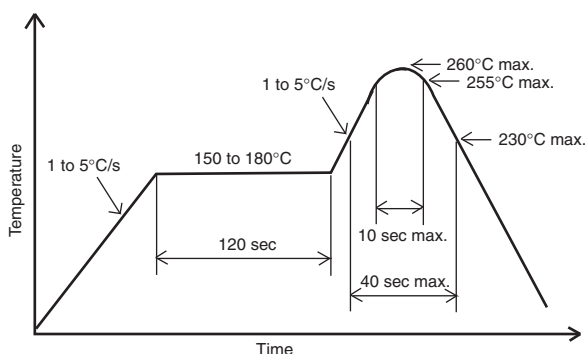

Manual soldering

- Use Sn60Pb40 (60% tin and 40% lead) or solder with silver content.
- Use a soldering iron of less than 25 W, and keep the temperature of the iron tip at 300°C or below.
- Solder each point for a maximum of three seconds.
- After soldering, allow the product to return to room temperature before handling it.

Storage

To protect the product from the effects of humidity until the package is opened, dry-box storage is recommended. If this is not possible, store the product under the following conditions:

Temperature: 10 to 30°C

Humidity: 60% max.

The product is packed in a humidity-proof envelope. Reflow soldering must be done within 48 hours after opening the envelope, during which time the product must be stored under 30°C at 80% maximum humidity.

If it is necessary to store the product after opening the envelope, use dry-box storage or reseal the envelope.

Baking

If a product has remained packed in a humidity-proof envelope for six months or more, or if more than 48 hours have lapsed since the envelope was opened, bake the product under the following conditions before use:

Reel: 60°C for 24 hours or more

Bulk: 80°C for 4 hours or more