



E222871

Multi-Function Rocker

## Specifications

Switch Function	SPST	Contact Resistance	<50mΩ initial
Electrical Ratings	UL61058-1	Dielectric Strength	1500Vrms min between contacts
	12A @ 125VAC, General Purpose, T105 6A @ 125VAC, General Purpose, T105	Insulation Resistance	>1000MΩ min @ 500VDC
Electrical Life	>10,000 cycles typical	Operating Temperature	-40°C to 105°C
		Storage Temperature	-40°C to 105°C
		Sealing Degree	IP40

## Materials

Actuator	6/6 Nylon, UL94V-0
Housing	6/6 Nylon, UL94V-0
Contacts	Silver Alloy
Terminals	Copper Alloy, Silver Plated

## Ordering Information

1. Series	RL	1	1	2	2	A	C
RL							
2. Number of Poles 1 = Single pole							
3. Switch Function 1 = OFF - ON 2 = OFF - (ON)							
4. Housing Color 1 = White 2 = Black							
5. Actuator Color 1 = White 2 = Black 3 = Red							
6. Actuator Marking: A D B E C N							
7. Actuator Marking Color Blank = No Marking B = Black W = White R = Red							
8. Terminal Options C = .187" Quick Connect / Solder Lug							

**Dimensions**

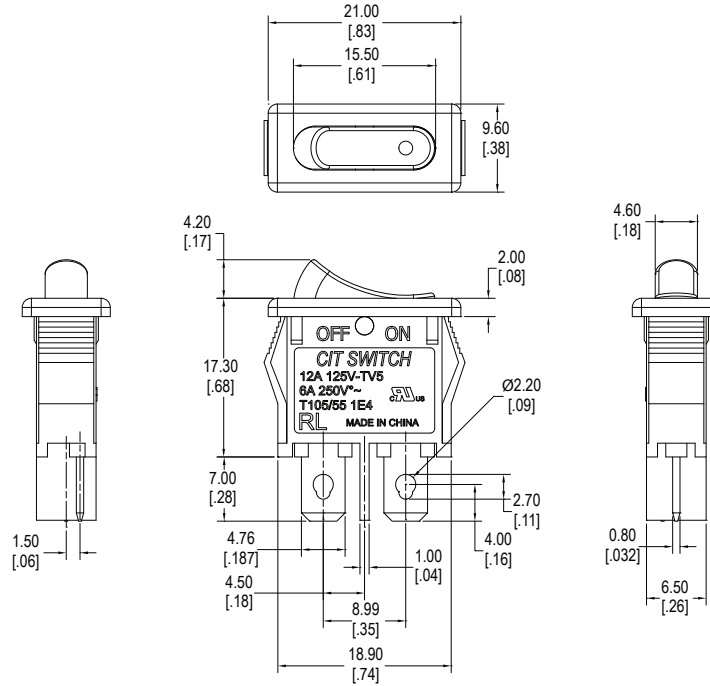

**Schematics**

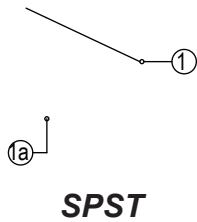

**Actuator Marking Options**

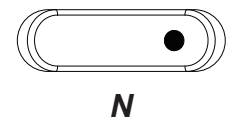
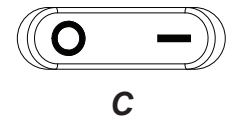
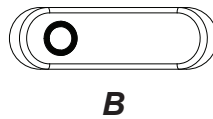
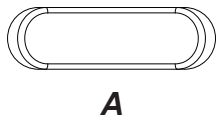

**Panel Cut Out**

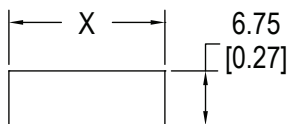

Panel Thickness	X
0.70 ~ 1.25	19.20~19.30
1.25 ~ 2.00	19.25~19.35
2.00 ~ 3.00	19.30~19.40