



Midas Touch

magic embedded

We are dedicated in image processing technology and customize the image quality to meet the real needs of customers.

There are many brand products with our advanced image technology in the market.

MCY-3410 Distortion Correction USB Camera Module Datasheet

Midas Touch, Inc.

17F-16, No. 1, Sec. 1, Zhongshan Rd., Banqiao Dist.,
New Taipei City 22063, Taiwan (R.O.C.)

Email: contact@midastouchinc.com

Tel: +886-2-7729-4139

Fax : +886-2-7729-4149



REVISION HISTORY

Rev.	DATE	Revision Description	PAGE
01	2019.6.21	Initial Release	



CONTENTS

ITEMS	PAGE
1. Camera specification	4
1.1 Feature	4
1.2 Sensor Block Diagram	5
1.3 Electrical specifications	6-8
2. Module View	9
3. Lens Spec	10
4. PCB Spec	11
5. Module Dimension	12
6. Pin Description	13
7. Connector Specification	14

1. Camera Specification

1.1 Feature

Item		Specifications
Sensor	Image Sensor	Omnivision 1/4" (OV9732)
	Resolution	1280x720
	Frame Rate	30fps
	Pixel Size	3um x 3um
	Operating Temperature	- 30°C~ 70°C
ISP	ISP	AVS7610
	Fisheye Lens Correction	AVS7610
	Max. Input Resolution	1920x1080
	Max. Output Resolution	1920x1080
	Max. Frame Rate	30fps
USB	USB Controller	SPCA2791A
	Image Format	MJPEG
	Interface	USB2.0
Lens	Total Track Length(TTL)	11.8
	F Number	2
	Field of view	193 °
	Construction	1G4P + IR
Power	Power consumption	200mA @5V
Module Dimension		34 x 34 x 19

1.2 Sensor Block Diagram

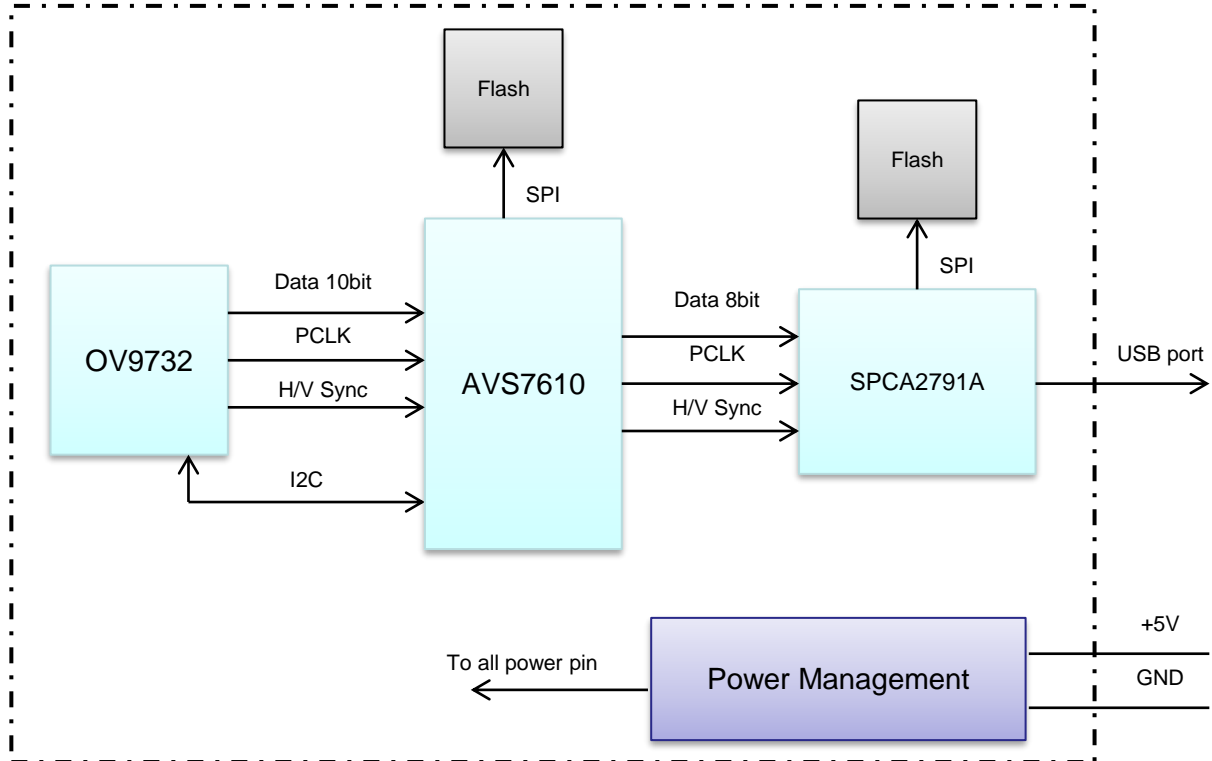

1.3 Electrical specifications

1.3.1 Sensor

- Absolute Maximum Ratings

Item	Min.	Max.	Units
Ambient storage temperature	- 40	125	°C
Operating Temperature	- 30	70	°C
Analog Supply Voltage	- 0.3	4.5	V
Digital Supply Voltage	- 0.3	4.5	V
IO Supply Voltage	- 0.3	4.5	V
DC Input Voltage	- 0.3	VDDIO + 1	V
ESD Rating, Human Body Model Machine Model		2000 200	V

- DC Characteristics

Symbol	parameter	Min.	Typ.	Max.	Unit
V_{DDA}	supply voltage (analog)	2.7	2.8	2.9	V
V_{DD}	supply voltage (digital core)	1.7	1.8	1.9	V
V_{DDIO}	supply voltage (digital I/O)	1.7	1.8	1.9	V
Operating current					
I_{DD-A}	active(operating) current		18	22	mA
I_{DD-D}			22	34	mA
I_{DD-IO}			5	13	mA
Standby current					
$I_{DDS-SCBB}$	standby current		20	150	μA
$I_{DDS-XSHUTDN}$			2	30	μA

1.3.2 USB Controller

-. Absolute Maximum Ratings

Symbol	parameter	Value	Unit
V_T	Voltage on any pin relative to VSS	-0.5 to 4.0	V
VDD	Supply Voltage relative to VSS	-0.5 to 4.0	V
T_{OPT}	Operating Temperature	0 to 70	°C
T_{STG}	Storage Temperature	-55 to 125	°C

-. DC Characteristics

Symbol	parameter	Min.	Typ.	Max.	Unit
OVDD	I/O operating voltage	1.62~3.0	1.8~3.3	1.98~3.6	V
DVDD	Core operating voltage	1.08	1.2	1.32	V
SVDD	Sensor interface voltage	1.62~3.0	1.8~3.3	1.98~3.6	V
PVDD	Crystal operation voltage	3.0	3.3	3.6	V
AVDD	Audio ADC operation voltage	3.0	3.3	3.6	V
AVDDTRX	USB Transmitter and Receiver voltage	3.0	3.3	3.6	V
MVDD	SMIA interface operation voltage	1.62	1.8	1.98	V
	MIPI interface operation voltage	1.08	1.2	1.32	V
I_{DD}	$I_{I/O}(\text{Suspend})$	–	–	350	μA
	$I_{Core}(\text{Suspend})$	–	–	1100	μA
I_{DD}	$I_{I/O}(\text{Operation in USB HS mode @FHD 30fps})$	–	40	45	mA
	$I_{Core}(\text{Operation in USB HS mode @FHD 30fps})$	–	75	85	mA

1.3.3 AVS7610 Controller

- Absolute Maximum Ratings

Symbol	parameter	Min.	Max.	Unit
TSTG	Ambient storage temperature	-40	150	°C
VDD33	3.3V power	TBD	TBD	V
VDD25	2.5V power	TBD	TBD	V
VDD18	1.8V power	TBD	TBD	V
VDD10	1.0V power	TBD	TBD	V

- DC Characteristics

Symbol	parameter	Min.	Typ.	Max.	Unit
VDD33 _{IH}	Input 3.3V voltage high	2			V
VDD33 _{IL}	Input 3.3V voltage low			0.8	V
VDD33 _{OH}	Output 3.3V voltage high	VDD33 – 0.4			V
VDD33 _{OL}	Output 3.3V voltage low			0.4	V
VDD25 _{IH}	Input 2.5V voltage high	1.7			V
VDD25 _{IL}	Input 2.5V voltage low			0.7	V
VDD25 _{OH}	Output 2.5V voltage high	VDD25 – 0.4			V
VDD25 _{OL}	Output 2.5V voltage low			0.4	V
VDD18 _{IH}	Input 1.8V voltage high	1.2			V
VDD18 _{IL}	Input 1.8V voltage low			0.6	V
VDD18 _{OH}	Output 2.5V voltage high	VDD18 – 0.4			V
VDD18 _{OL}	Output 2.5V voltage low			0.4	V
R _{pull}	Pull up or down resistance (1.8/2.5/3.3V)		65/53/39		KW
I _L	Input leakage	-10		10	μA
C _{IN}	Input capacitance			3	pF

2. Module View

- Front View

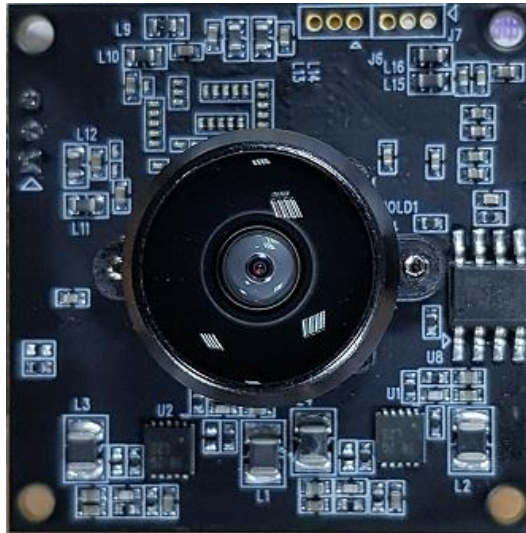

- Rear View

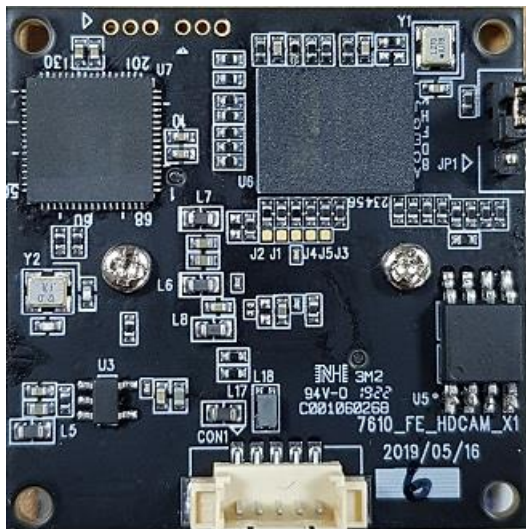



Rev	01
Date	2019.6.21

3. Lens spec

MATERIAL		SURFACE TEXTURE	
PPS: TORELIN A504X90 Black 再生材不可		HEAT TREATMENT	
		SURFACE TREATMENT	
UNLESS OTHERWISE NOTED			
TYPE	DL5706210A		
No. OF UNIT	No. OF REQUIRED	S/W	No. OF REV.
DESCRIPTION	EC. No.	DATE	DESIGN APPR.
日本電産子午株式会社 NIDEC SANKYO CORPORATION			
PROJECTION UNIT	SCALE	TOLERANCE	TITLE
PROJECTION UNIT	5:1	±0.1 ±1*	HOLDER
SECTION	DWG		DRAWING No.
DESIGN KAWADA JIMATSUKI	CHECK		M59A523A01
THUNDER	CHECK		01 / 01
			100A002001

4. PCB Spec

GERBER DATA (6 Layer, Pattern tolerance 10%)

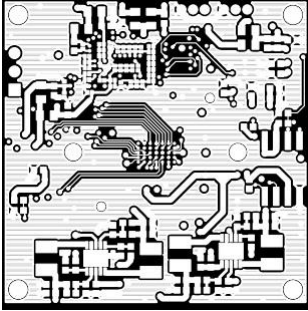
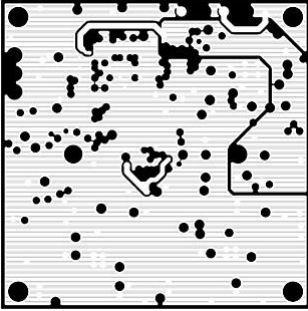
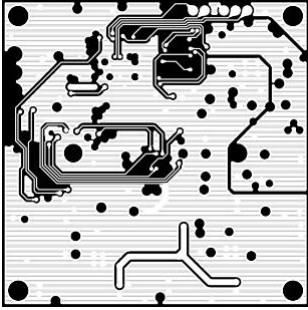
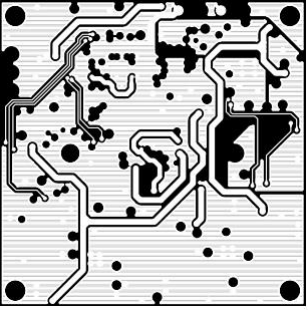
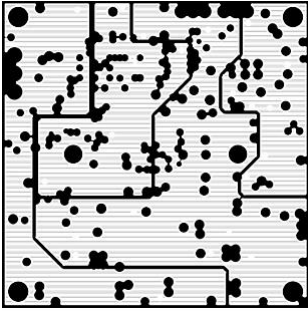
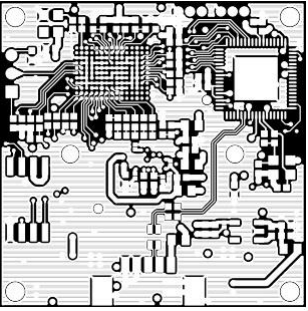
<p style="text-align: center;">Layer 1, Top</p>	<p style="text-align: center;">Layer 2, Inner</p>
	
<p style="text-align: center;">Layer 3, Inner</p>	<p style="text-align: center;">Layer 4, Inner</p>
	
<p style="text-align: center;">Layer 5, Inner</p>	<p style="text-align: center;">Layer 6, Bottom</p>
	

5. Module Dimension

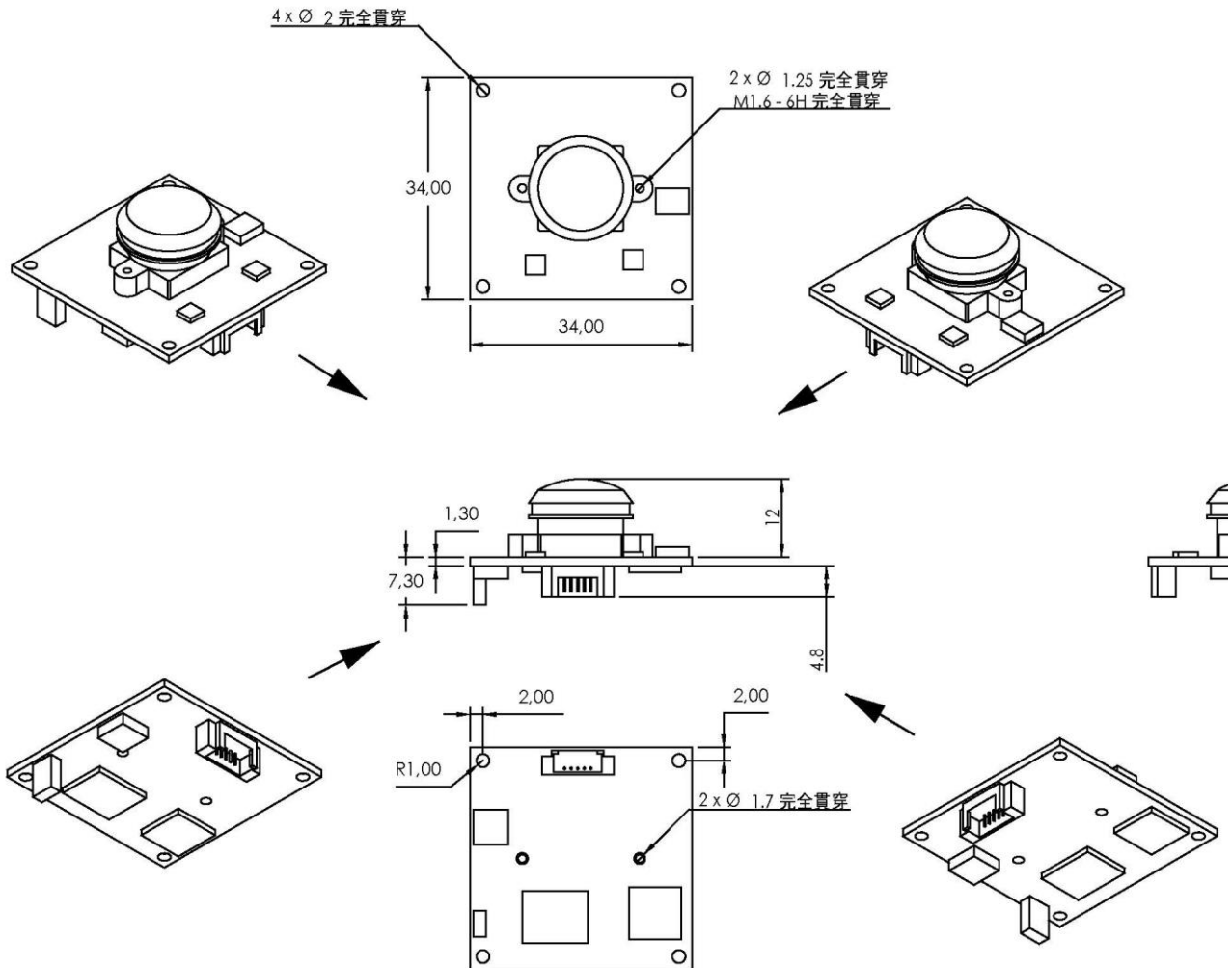

6. Pin Description

Pin Description			
Pin Number	Name	Pin Type	Function Description
1	VCC	Power	USB Power Supply 5.0V
2	D-	Data Pin	USB Data Transmission
3	D+	Data Pin	USB Data Transmission
4	NC	NC	NC
5	GND	GND	System Ground

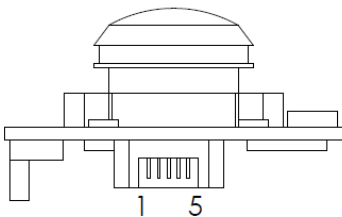

5pin WTB Connector
pitch 1.25mm

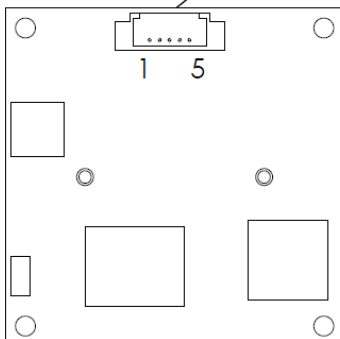

7. Connector Specification

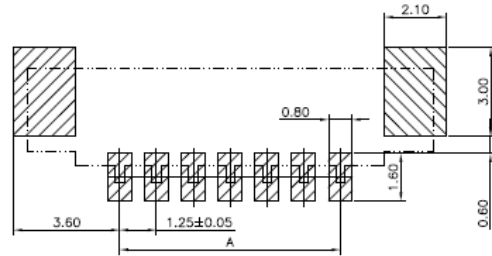
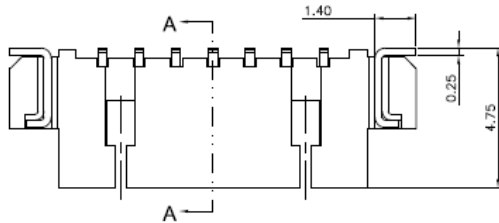

Recommended P.C.Board Layout

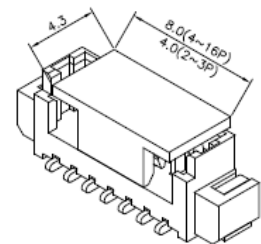
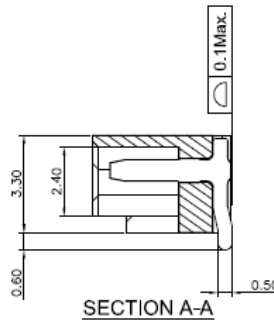
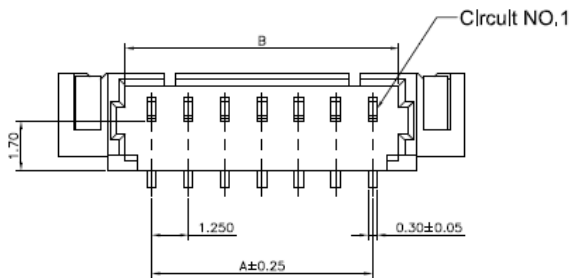

WITH CAP VIEW

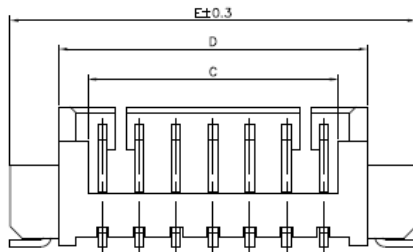

CTK	DIMENSIONS				
	A	B	C	D	E Δ
2	1,25	3,05	2,25	4,25	7,25
3	2,50	4,30	3,50	5,50	8,50
4	3,75	5,55	4,75	6,75	9,75
5	5,00	6,80	6,00	8,00	11,00
6	6,25	8,05	7,25	9,25	12,25
7	7,50	9,30	8,50	10,50	13,50
8	8,75	10,55	9,75	11,75	14,75
9	10,00	11,80	11,00	13,00	16,00
10	11,25	13,05	12,25	14,25	17,25
11	12,50	14,30	13,50	15,50	18,50
12	13,75	15,55	14,75	16,75	19,75
13	15,00	16,80	16,00	18,00	21,00
14	16,25	18,05	17,25	19,25	22,25
15	17,50	19,30	18,50	20,50	23,50
16	18,75	20,55	19,75	21,75	24,75