



80CNQ SERIES SCHOTTKY RECTIFIER

Applications

- Switching power supply
- Converters
- Free-Wheeling diodes
- Reverse battery protection

Features

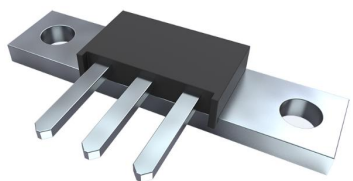
- 150°C T_J operation
- Center tap module
- Very Low forward voltage drop
- High purity, high temperature epoxy encapsulation for enhanced mechanical strength and moisture resistance
- High frequency operation
- Guard ring for enhanced ruggedness and long term reliability
- Low profile, high current package
- This is a Pb – Free Device
- All SMC parts are traceable to the wafer lot
- Additional electrical and life testing can be performed upon request

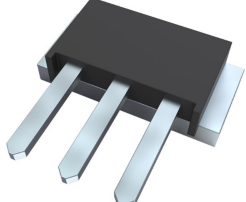
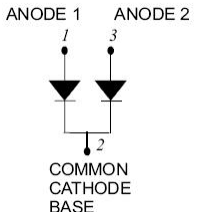
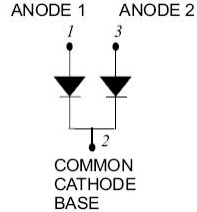
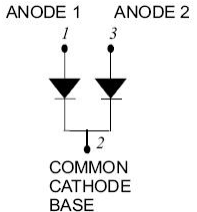
80CNQ...	80CNQ...SL	80CNQ...SM
		
		
PRM2	PRM2-SL	PRM2-SM

Maximum Ratings:

Characteristics	Symbol	Condition	Max.	Units
Peak Repetitive Reverse Voltage Working Peak Reverse Voltage DC Blocking Voltage	V _{RRM} V _{RWM} V _R	-	35(80CNQ035) 40(80CNQ040) 45(80CNQ045)	V
Average Rectified Forward Current	I _{F (AV)}	50% duty cycle @T _C =114°C, rectangular wave form	40(Per Leg) 80(Per Device)	A
Peak One Cycle Non-Repetitive Surge Current(Per leg)	I _{FSM}	8.3 ms, half Sine pulse	900	A
Non-Repetitive Avalanche Energy (Per leg)	E _{AS}	T _J =25°C, I _{AS} =8A, L=1.7mH	54	mJ
Repetitive Avalanche Current(Per leg)	I _{AR}	Current decaying linearly to zero in 1 μsec Frequency limited by T _J max. V _A =1.5×V _R typical	8	A

Electrical Characteristics:

Characteristics	Symbol	Condition	Typ.	Max.	Units
Forward Voltage Drop (Per leg) *	V _{F1}	@ 40A, Pulse, T _J = 25 °C	0.51	0.55	V
		@ 80A, Pulse, T _J = 25 °C	0.56	0.66	
	V _{F2}	@ 40A, Pulse, T _J = 125 °C	0.45	0.47	V
		@ 80A, Pulse, T _J = 125 °C	0.46	0.61	
Reverse Current (Per leg) *	I _{R1}	@V _R = rated VR T _J = 25 °C	0.2	5	mA
	I _{R2}	@V _R = rated VR T _J = 125 °C	100	250	mA
Junction Capacitance (Per leg)	C _T	@V _R = 5V, T _C = 25 °C f _{sig} = 1MHz	2000	2600	pF

* Pulse width < 300 μs, duty cycle < 2%

Thermal-Mechanical Specifications:

Characteristics	Symbol	Condition	Specification	Units
Junction Temperature	T _J	-	-55 to +150	°C
Storage Temperature	T _{stg}	-	-55 to +150	°C
Typical Thermal Resistance Junction to Case (per leg)	R _{θJC}	DC operation	0.85	°C/W
Typical Thermal Resistance Junction to Case (per package)	R _{θJC}	DC operation	0.42	°C/W
Typical Thermal Resistance, case to Heat Sink	R _{θcs}	Mounting surface, smooth and greased	0.30	°C/W
Mounting Torque	TM	-	40(min)	Kg-cm
			58(max)	
Approximate Weight	wt	-	7.8	g
Case Style	PRM2 PRM2-SL PRM2-SM			

Ratings and Characteristics Curves

Typical Forward Characteristics

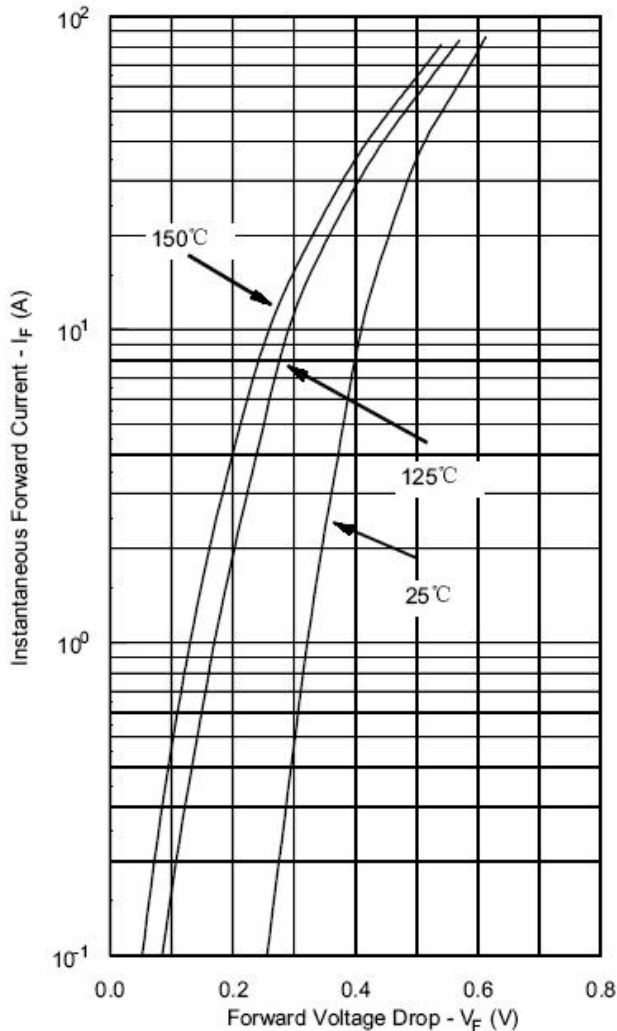

Typical Reverse Characteristics

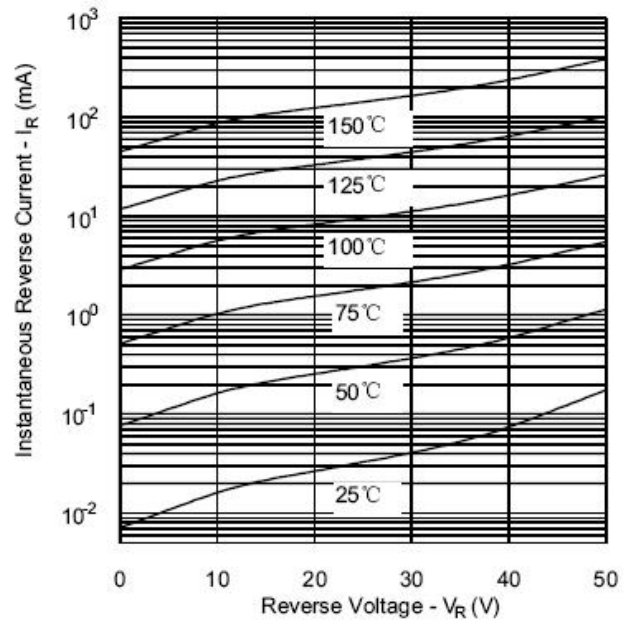

Typical Junction Capacitance

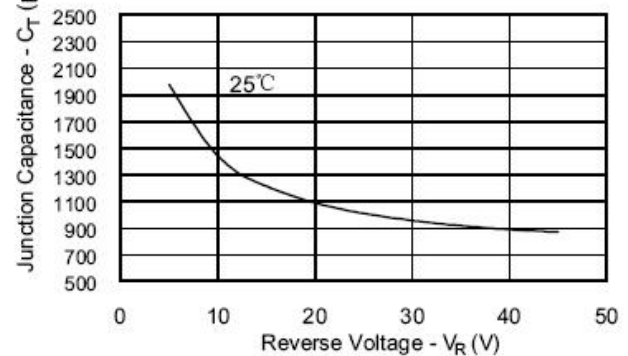

Marking Diagram

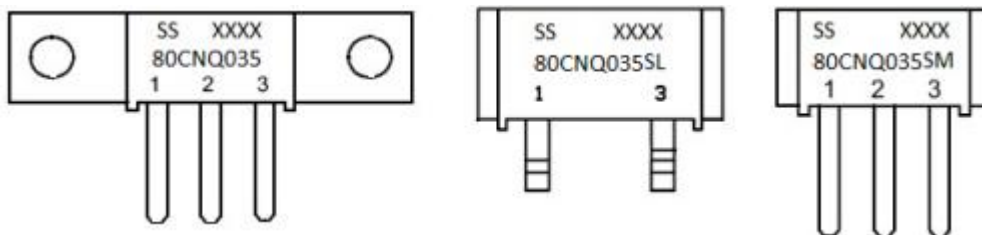

Where XXXX is YYWW

1st row SS YYWWL
2nd row 80CNQ035/SL/SM
3rd row 1 2 3 (pin)
SS = SS
YY = Year
WW = Week

Cautions: Molding resin
Epoxy resin UL:94V-0

Ordering Information

Device	Package	Terminals finish	Baseplate finish	Shipping
80CNQ035	PRM2	Nickel plated	Nickel plated	48pcs / box
80CNQ035S2	PRM2	Pure Sn dipped (dipped heigh 6-8mm)	Nickel plated	48pcs / box
80CNQ035SL	PRM2-SL	Pure Sn plated	Pure Sn plated	100pcs / box
80CNQ035SM	PRM2-SM	Nickel plated	Nickel plated	48pcs / box
80CNQ035SMS2	PRM2-SM	Pure Sn dipped (dipped heigh 6-8mm)	Nickel plated	48pcs / box
80CNQ040	PRM2	Nickel plated	Nickel plated	48pcs / box
80CNQ040S2	PRM2	Pure Sn dipped (dipped heigh 6-8mm)	Nickel plated	48pcs / box
80CNQ040SL	PRM2-SL	Pure Sn plated	Pure Sn plated	100pcs / box
80CNQ040SM	PRM2-SM	Nickel plated	Nickel plated	48pcs / box
80CNQ040SMS2	PRM2-SM	Pure Sn dipped (dipped heigh 6-8mm)	Nickel plated	48pcs / box
80CNQ045	PRM2	Nickel plated	Nickel plated	48pcs / box
80CNQ045S2	PRM2	Pure Sn dipped (dipped heigh 6-8mm)	Nickel plated	48pcs / box
80CNQ045SL	PRM2-SL	Pure Sn plated	Pure Sn plated	100pcs / box
80CNQ045SM	PRM2-SM	Nickel plated	Nickel plated	48pcs / box
80CNQ045SMS2	PRM2-SM	Pure Sn dipped (dipped heigh 6-8mm)	Nickel plated	48pcs / box

Mechanical Dimensions PRM2 (Inches/Millimeters)

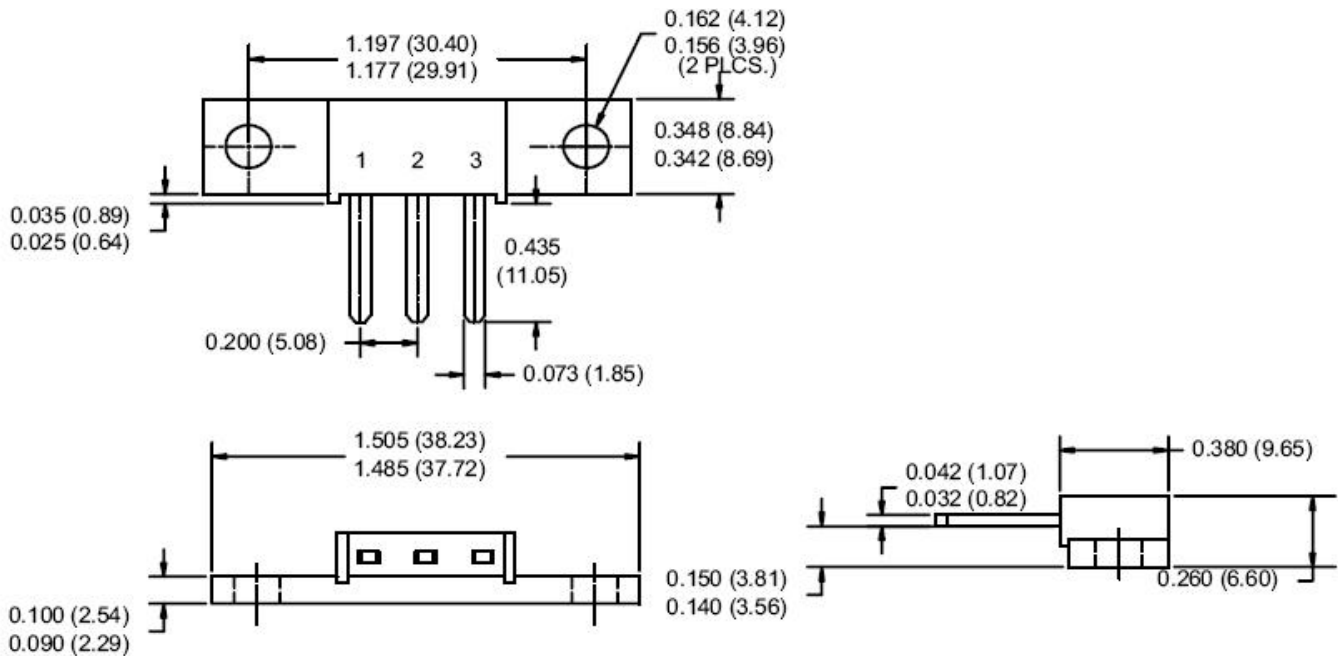

Mechanical Dimensions PRM2-SL (Inches/Millimeters)

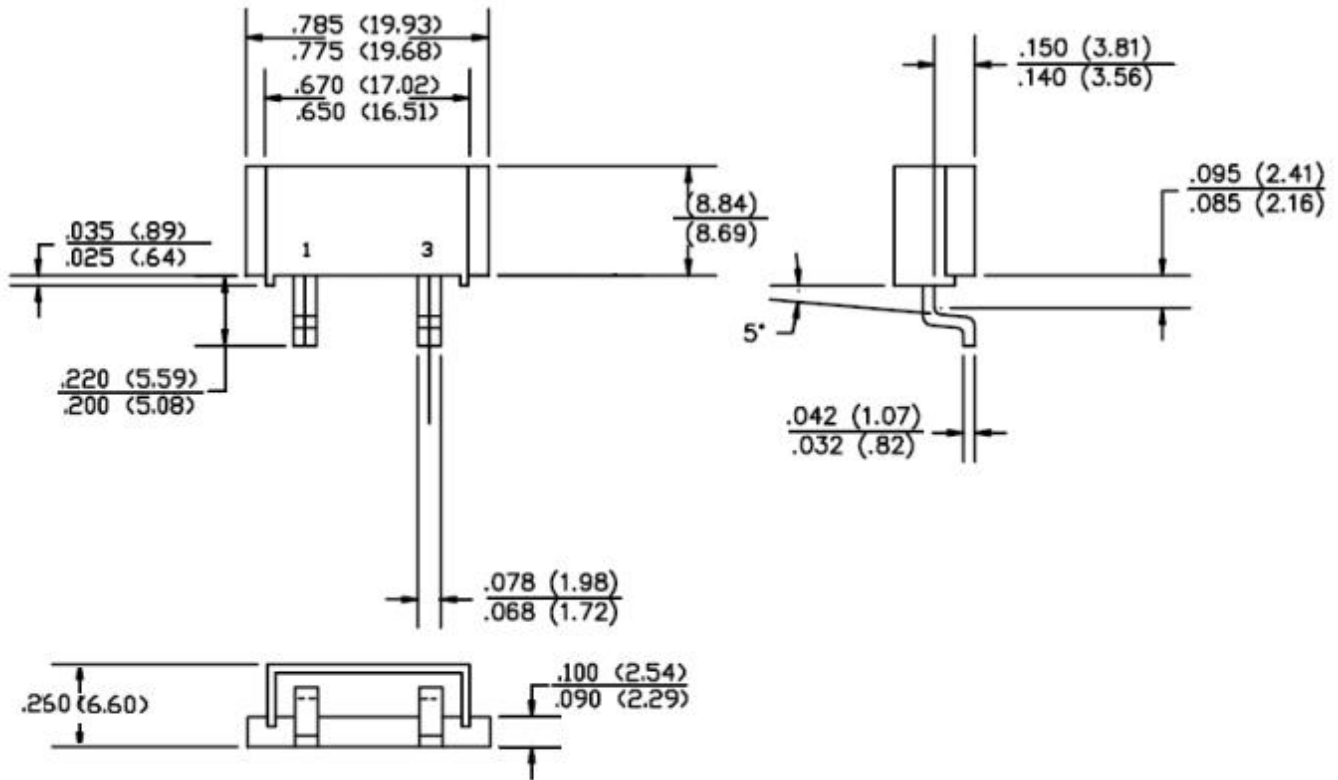

Mechanical Dimensions PRM2-SM (Inches/Millimeters)

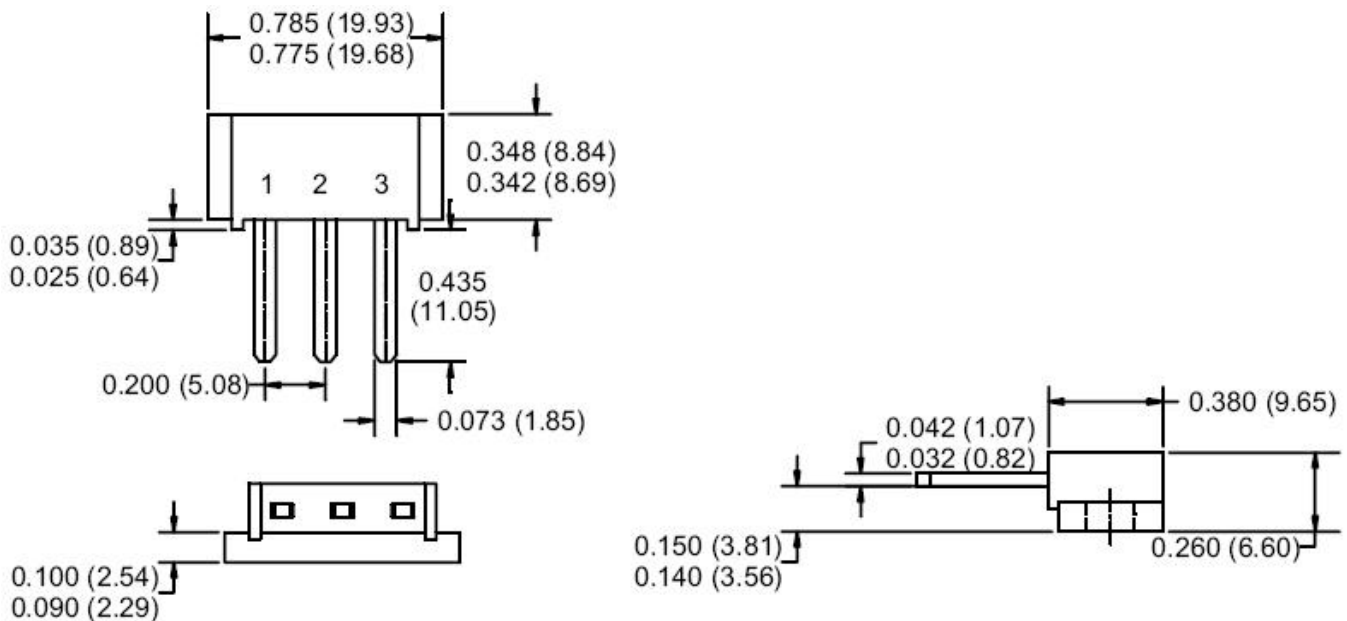



DISCLAIMER:

- 1- The information given herein, including the specifications and dimensions, is subject to change without prior notice to improve product characteristics. Before ordering, purchasers are advised to contact the SMC Diode Solutions sales department for the latest version of the datasheet(s).
- 2- In cases where extremely high reliability is required (such as use in nuclear power control, aerospace and aviation, traffic equipment, medical equipment, and safety equipment), safety should be ensured by using semiconductor devices that feature assured safety or by means of users' fail-safe precautions or other arrangement.
- 3- In no event shall SMC Diode Solutions be liable for any damages that may result from an accident or any other cause during operation of the user's units according to the datasheet(s). SMC Diode Solution assumes no responsibility for any intellectual property claims or any other problems that may result from applications of information, products or circuits described in the datasheets.
- 4- In no event shall SMC Diode Solutions be liable for any failure in a semiconductor device or any secondary damage resulting from use at a value exceeding the absolute maximum rating.
- 5- No license is granted by the datasheet(s) under any patents or other rights of any third party or SMC Diode Solutions.
- 6- The datasheet(s) may not be reproduced or duplicated, in any form, in whole or part, without the expressed written permission of SMC Diode Solutions.
- 7- The products (technologies) described in the datasheet(s) are not to be provided to any party whose purpose in their application will hinder maintenance of international peace and safety nor are they to be applied to that purpose by their direct purchasers or any third party. When exporting these products (technologies), the necessary procedures are to be taken in accordance with related laws and regulations..