

Loop Powered Scaling Meter

Unit Description

◎ M4NS-NA

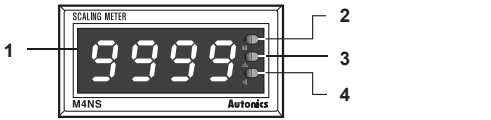

1. Display value, parameter, error display
2. M, **MD** key: When enter into parameter group, return to RUN mode, after completing parameter setting

◎ M4YS-NA

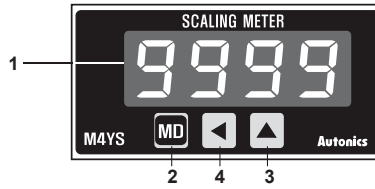

3. **▲**, **▲** key: When enter into the status of parameter setting
4. **▲**, **◀** key: When enter into the status of parameter setting and move digit

Dimensions

(unit: mm)

◎ M4NS-NA

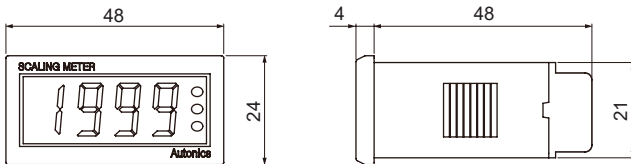

• Bracket

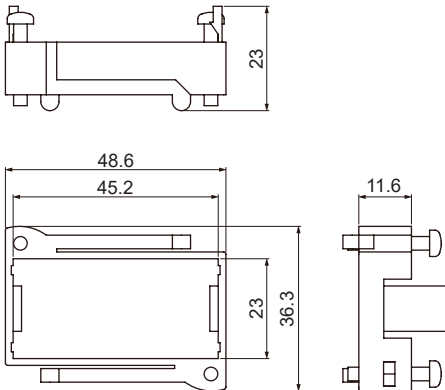

• Panel cut-out

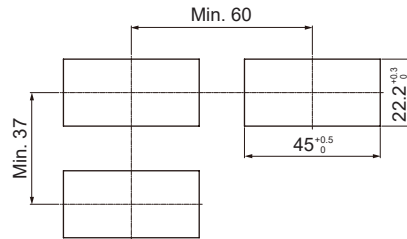

◎ M4YS-NA

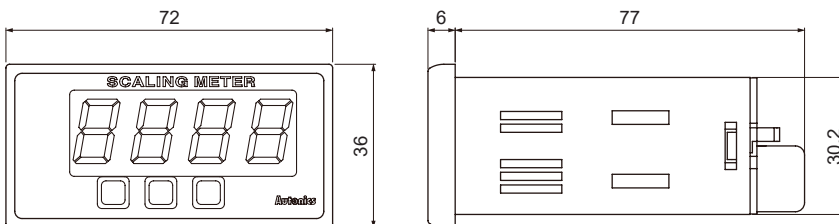

• Bracket

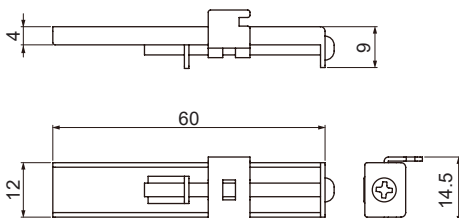

• Panel cut-out

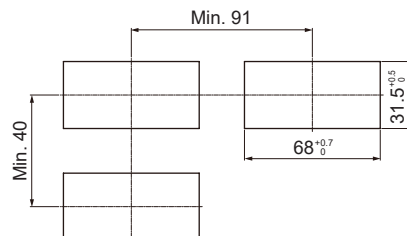

SENSORS
CONTROLLERS
MOTION DEVICES
SOFTWARE

(J) Temperature Controllers
(K) SSRs
(L) Power Controllers
(M) Counters
(N) Timers
(O) Digital Panel Meters
(P) Indicators
(Q) Converters
(R) Digital Display Units
(S) Sensor Controllers
(T) Switching Mode Power Supplies
(U) Recorders
(V) HMIs
(W) Panel PC
(X) Field Network Devices

Parameter 0 Group (Monitoring Mode)

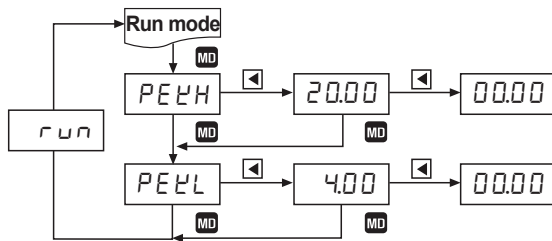

1. Pressing **MD** key to enter monitoring mode in RUN mode.
2. Each Max./Min. value will be shown by pressing **◀** key in monitoring mode and Max./Min. value will be initialized by pressing **▶** key once more.
3. If no key touched for 60 sec, it will return to RUN mode.
4. When do not use monitoring function, set **00 5** for **PEEL** in parameter setting.

Parameter 1 Group

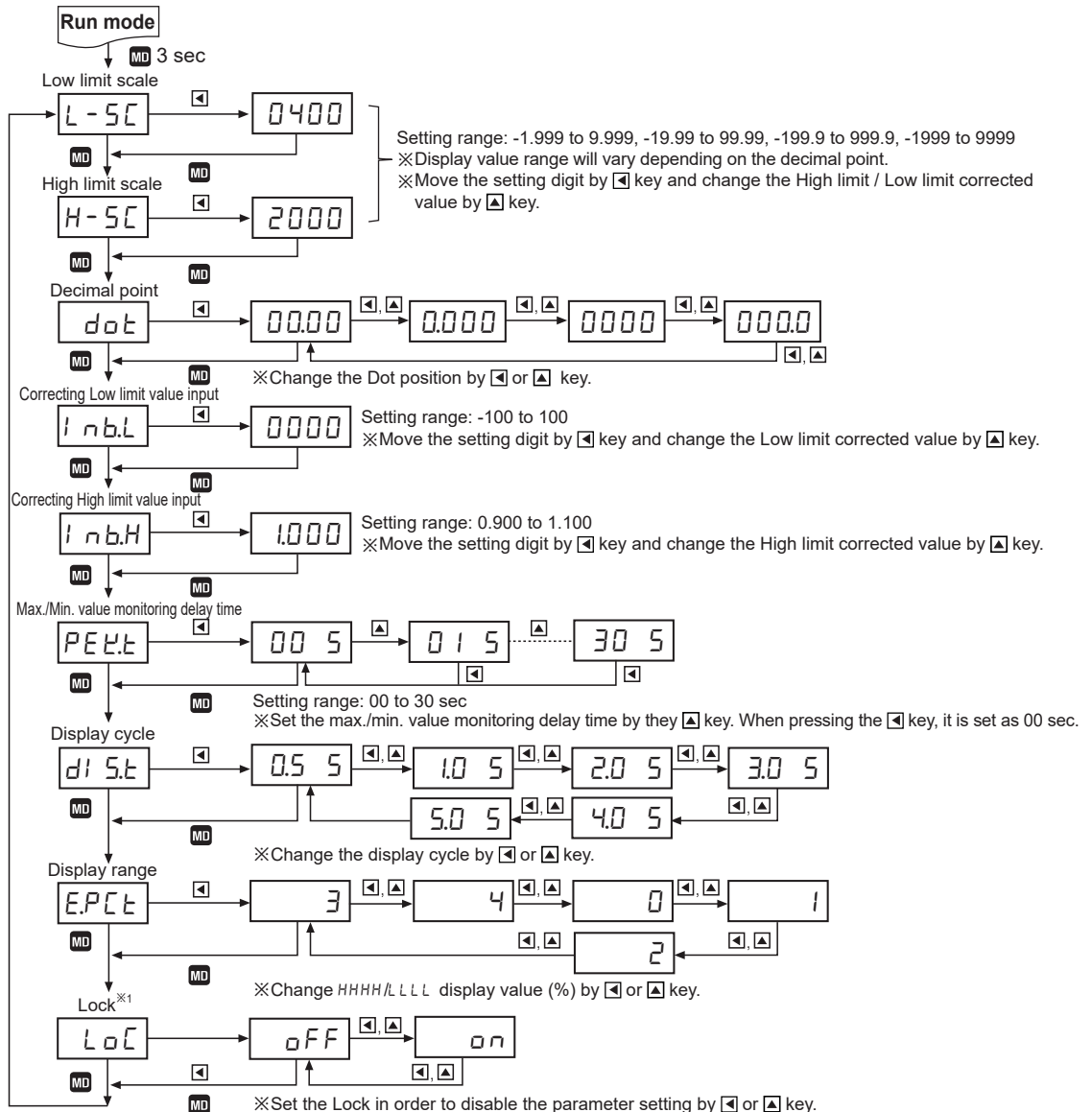

- ※ Press the **MD** key after changing the setting value of the parameter, the setting value is saved and it moves to next parameter.
- ※ After entering setting parameter, hold the **MD** key for 3 sec, it displays **run** and returns to RUN mode
- ※ If any key is untouched for 60 sec, it will return to RUN mode.
- ※ 1: Lock **OFF**: Enable to change or set Parameter.
ON: Disable to change or set Parameter but enable to check the setting value in Parameter group.
 Disable to enter into the status of change setting value by pressing **◀**, **▶** keys.

Loop Powered Scaling Meter

Parameter

Display	Function	Setting range	Factory default	
L-SC	Low scale	Low limit display value for 4mA input	-1.999 to 9.999, -19.99 to 99.99, -199.9 to 999.9, -1999 to 9999	0400
H-SC	High scale	High limit display value for 20mA input	0000 to 9999	2000
dot	Decimal point	Set Decimal point position	0000, 000.0, 00.00, 0.000	00.00
lnbL	Input bias low	Correct the Low-limit value of display value (digit)	-100 to 100	0000
lnbH	Input bias high	Correct the High-limit value of display value (%)	0.900 to 1.100	1.000
PELT	Max./Min. time	See the Max./Min. value monitoring delay time (sec)	0 to 30	015
dlSt	Display time	Selectable sampling period (sec)	0.5, 1.0, 2.0, 3.0, 4.0, 5.0	0.55
EPCL	Error %	Set % of HHHH/LLLL display range	0, 1, 2, 3, 4	3
LoC	Lock	Set the lock function	ON, OFF	OFF

Connections

M4NS-NA

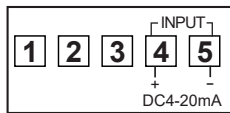

M4YS-NA

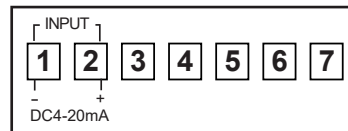

※Use terminals of size specified below.

	a	b
 <Forked>	Min. 3.5mm	Min. 7.0mm

Connections of Applications

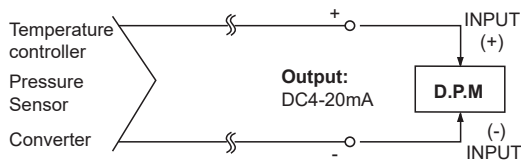

SENSORS

CONTROLLERS

MOTION DEVICES

SOFTWARE

(J)
Temperature
Controllers

(K)
SSRs

(L)
Power
Controllers

(M)
Counters

(N)
Timers

(O)
Digital
Panel Meters

(P)
Indicators

(Q)
Converters

(R)
Digital
Display Units

(S)
Sensor
Controllers

(T)
Switching
Mode Power
Supplies

(U)
Recorders

(V)
HMIs

(W)
Panel PC

(X)
Field Network
Devices

■ Functions

◎ Display scale [L - 5C / H - 5C]

This function is to display the value setting certain Hi/Low limit value against DC4-20mA input. For example if set a=DC4mA, b=DC20mA and A, B as display value, it will be displayed a=A, b=B.

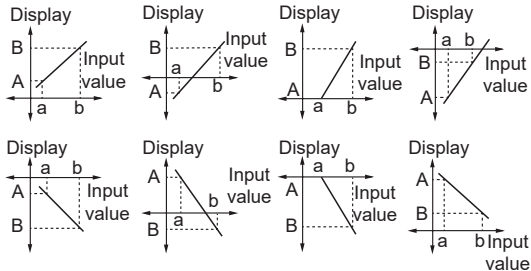

◎ Correction [InbH / InbL]

This function is to adjust the error of display value after calculating scale value for measuring input and also correct the input error of sensor etc.

$InbL$: -100 to 100 [Adjust deviation of low value]

$InbH$: 0.900 to 1.100 [Correct gradient (%) of high value]

E.g.) When display value is 0.0 to 500.0 against 4-20mA input, if the display value is "1.2" for 4mA input, set -12 (ignore the decimal point) as $InbL$ value to display "0.0". It is enable to remove offset of Low display value.

※ When completed above Low value setting then apply 20mA, if the display value is "500.5, the correction value will be $5005/5000=0.999$, set 0.999 as $InbH$ value then enable to correct High value is $5005 \times 0.999 = 5000$. It is also ignore the decimal point.

◎ Display Max./Min. value monitoring

[PEEH / PEEL]

This function is to monitor Max. value and Min. value by current display value then display its Data in PEEH mode and PEEL mode.

Enable to set delay time in PEEL mode to protect the wrong Data by initial over current and set table from 0 to 30 sec and start to monitor after delay time.

◎ Display cycle delay

It is difficult to display when the measuring input value is fluctuating. In this case it is able to make display value stable by delaying display cycle.

Display cycle can be changed in d1 5t mode of Parameter 2 (0.5s/1.0s/2.0s/3.0s/4.0s/5.0s).

If select 5.0 5, it will be the measuring input value on an average for 5 sec, then display it every 5 sec.

◎ Error display [E.P.C.E.]

● Error display

- ① When LLLL flashes,
 - 1) Input current is lower than 3% in 4-20mADC (16mA scale) LLLL will flash when it is under 3.52mA [$16mA \times 3\% = 0.48mA$] $\rightarrow 4mA - 0.48mA = 3.52mA$
 - 2) When it is beyond Min. display value (-1999) [by display value]
- ② When HHHH flashes,
 - 1) Input current is higher than 3% in 4-20mADC (16mA scale) HHHH flash [$16mA \times 3\% = 0.48mA$] $\rightarrow 20mA + 0.48mA = 20.48mA$.
 - 2) When it is higher than 20.48mA. When it is beyond Max. display value (9999) [by display value]

● Turn Error display off

LLLL and HHHH are displayed when input is out of measuring range, therefore it will be disappeared automatically when input returns to measuring range

● Error setting and sort

It will display the error message according to the setting value which set % value against analog input range and set it in E.P.C.E. mode by [◀], [▶] key.

Display		Description
E.P.C.E.	1	LLLL / HHHH are displayed when it is over 0% out DC4-20mA range
E.P.C.E.	2	LLLL / HHHH are displayed when it is over 1% out DC4-20mA range
E.P.C.E.	3	LLLL / HHHH are displayed when it is over 2% out DC4-20mA range
E.P.C.E.	4	LLLL / HHHH are displayed when it is over 3% out DC4-20mA range
E.P.C.E.	5	L - 5C / H - 5C are displayed always when it is out of DC4-20mA range