

AM Superhet receiver with crystal oscillator 433.92MHz

RCRX-434 is an AM superhet data receiver with PLL synthesizer and crystal oscillator. ASK/OOK modulation. Metallic shield.
 RCRX-434 ---> 5 Volt version.
 RCRX-434-L ---> 3 Volt version.



On request is possible to customize the frequency.

Technical Characteristics

Characteristics	MIN	TYP	MAX	UNIT
V _{cc} Supply Voltage	3.0 / 4.4		3.6 / 5.0	Vdc
I _s Current Consumption (RX mode)		5.5		mA
I _s Current Consumption (Shut down mode)		1		µA
S RF Sensitivity		-108		dBm
D Max Data Rate		10		Kbit/s
B RF Bandwidth 3dB		600		KHz
T Operating Temperature Range	-25		+80	°C

Pin Description

Pads	Name	Description
1	ANT	External antenna
2,3	GND	Ground
4	PD	Power Down
5	DOUT	Data Out
6,7	GND	Ground
8	VCC	Power Supply



PD = 0V ----> RX ON
 PD = 5V ----> RX OFF

Mechanical dimensions

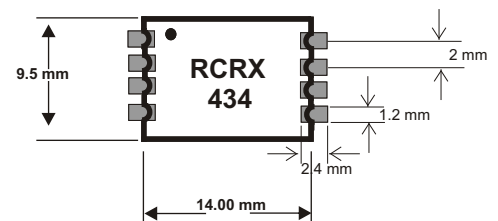

Typical Application

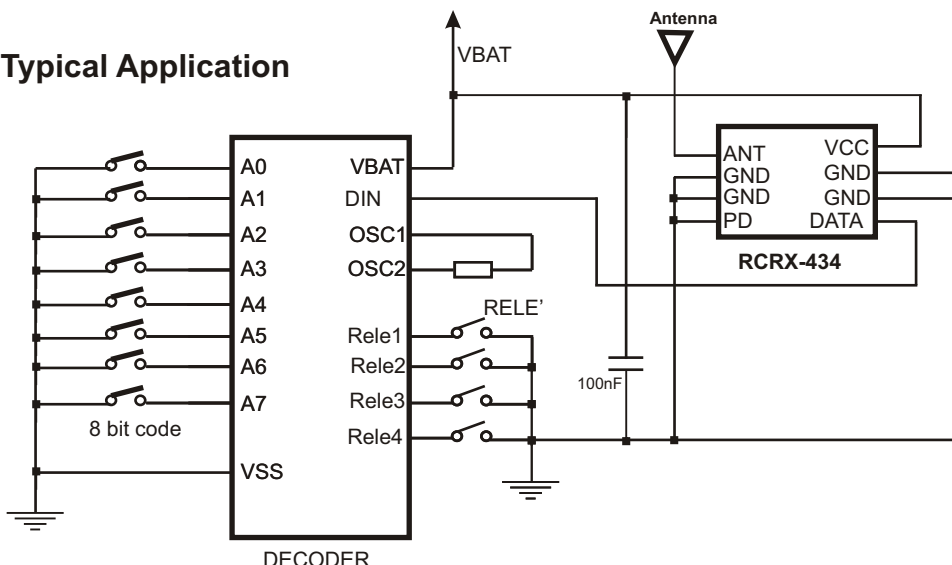

Applications :

- Wireless security systems
- Home and building automation
- Automatic Measure Reading
- Wireless Sensor Network

**ETSI EN 300 220
COMPLIANCE**