

ECN/PCN No.: R0043

For Manufacturer			
<b>Product Description:</b> Bluetooth modules	<b>Abracon Part Number / Part Series:</b> ABBTM Bluetooth module series	<input type="checkbox"/> Documentation only <input type="checkbox"/> ECN <input checked="" type="checkbox"/> EOL	<input checked="" type="checkbox"/> Series <input type="checkbox"/> Part Number
<b>Affected Revision:</b> N/A	<b>New Revision:</b> EOL	<b>Application:</b> <input type="checkbox"/> Safety <input checked="" type="checkbox"/> Non-Safety	
<b>Prior to Change:</b> ABBTM-2.4GHZ, ABBTM-2.4GHZ-31, ABBTM-2.4GHZ-31-T, ABBTM-2.4GHZ-33, ABBTM-2.4GHZ-33-T, ABBTM-2.4GHZ-51, ABBTM-2.4GHZ-51-T, ABBTM-2.4GHZ-52, ABBTM-2.4GHZ-52-T, ABBTM-2.4GHZ-EVAL, ABBTM-2.4GHZ-T, ABBTM-2.4GHZ-T2, ABBTM-NVC-EVK-56, ABBTM-NVC-EVK-71, ABBTM-NVC-EVK-71-MESH, ABBTM-NVC-MB-EVK, ABBTM-NVC-MDCS42A-CON, ABBTM-NVC-MDCS71, ABBTM-NVC-MDCS71-CON, ABBTM-NVC-MDCS71-MESH, ABBTM-NVC-MDCS71-MESH-CON, ABBTM-NVC-MDCS71-101, ABBTM-NVC-MDCS86-101, ABBTM-101-2.4GHZ-T, ABBTM-2.4GHZ-51-101-, ABBTM-2.4GHZ-52-101, ABBTM-53-2.4GHZ-T, ABBTM-103-2.4GHZ-T, ABBTM-2.4GHZ-T; VER.10, ABBTM-NVC-MDCS42A-101, ABBTM-NVC-MDCS42A-F07, and ABBTM-NVC-MDCS56-102.			
<b>After Change:</b> All 32 EOL			
<b>Cause/Reason for Change:</b> Due to low demand, the Bluetooth Module ABBTM series is discontinued.			
Change Plan			
<b>Effective Date:</b> 06/08/2021	<b>Additional Remarks:</b> N/A		
<b>Change Declaration:</b> EOL			
<b>Issued Date:</b> 06/08/2021	<b>Issued By:</b> <i>Nicholas El-Takach</i>	<b>Issued Department:</b> Engineering	
<b>Approval:</b> <i>Syed Raza</i> Engineering VP	<b>Approval:</b> <i>Reuben Quintanilla</i> Quality Director	<b>Approval:</b> <i>Ying Huang</i> Purchasing Director	
For Abracon EOL only			
<b>Last Time Buy (if applicable):</b> No last time buy.	<b>Alternate Part Number / Part Series:</b> N/A		
<b>Additional Approval:</b>	<b>Additional Approval:</b>	<b>Additional Approval:</b>	
Customer Approval (If Applicable)			
<b>Qualification Status:</b> <input type="checkbox"/> Approved <input type="checkbox"/> Not accepted <i>Note: It is considered approved if there is no feedback from the customer 1 month after ECN/PCN is released.</i>			
<b>Customer Part Number:</b>		<b>Customer Project:</b>	
<b>Company Name:</b>	<b>Company Representative:</b>	<b>Representative Signature:</b>	
<b>Customer Remarks:</b>			

# 23.3 x 11.93 x 2.0 mm SMT Bluetooth Module

ABBTM-2.4GHz-52-T

Compliant to MSL level 3



RoHS  
Compliant

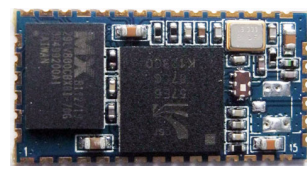

23.3 x 11.93 x 2.0 mm SMT

## FEATURES:

- Bluetooth Spec v2.1 Compliant
- Class 2, up to 10-meter range
- Complete 2.4GHz Bluetooth® System
- Power management: low power 1.5V operation for Bluetooth® core
- Compact size: 23.23mm (L) x 11.93 (W) mm x 2.0mm (H)
- Bluetooth® Profile Supported: HSP, HFP, A2DP, AVRCP
- Built-in 16-bit stereo codec – 92dB SNR for DAC
- On-board flash memory (16 Mbits)
- Optional echo cancellation software library
- Support 802.11 co-existence
- Surface mount module for embedded applications
- Several firmware options
- Rewritable flash memory for easy upgrade route
- Custom firmware production available

## APPLICATIONS:

- Stereo Bluetooth® headset/headphone
- Automotive car kit applications
- Personal Navigation Devices
- PDAs and other portable terminals
- MP3 headset
- High-end noise cancellation mono headset
- AV Dongle

## GENERAL DESCRIPTION

Abrakon's ABBTM-2.4GHz-52-T module is a complete Bluetooth® solution built on CSR BC05 MultiMedia External Core, supported by 16 Mbits on-board Flash Memory. ABBTM-2.4GHz-52-T is a short range, compact, cost effective solution designed to Bluetooth® connectivity for applications including PND, Car & Home Audio and other Handsfree applications.

ABBTM-2.4GHz-52-T module is a Power Class-2 Bluetooth® device, compliant with version 2.1 of specification. The overall architecture comprises of a radio front-end, antenna interface & supporting circuitry for software protocols including L2CAP, SDP, GAP, HSP, HFP, A2DP and AVRCP resident in the on-board Flash Memory

## ELECTRICAL SPECIFICATIONS:

Operating Frequency Band	2.4GHz ~ 2.48GHz Unlicensed ISM Band
Bluetooth Specification	V2.1
Output Power Class	Class 2
Operating Voltage	+3.3V
Host Interface	UART
Audio Interface	Analog
Flash Memory Size	16 Mbits

### Absolute Maximum Ratings

	Minimum	Maximum
Storage temperature	-40°C	+105°C
Supply voltage: VBAT	-0.30V	3.6V

### Recommended Operating Conditions

	Minimum	Maximum
Operating temperature range	-40°C	+85°C
Supply voltage: Vcc	+3.0V	+3.6V
Supply voltage: Vdd	+1.42V	+1.57V

Test Conditions: Vcc=3.3V; F=2.45GHz; T=20°C



# 23.3 x 11.93 x 2.0 mm SMT Bluetooth Module

ABBTM-2.4GHz-52-T



RoHS  
Compliant

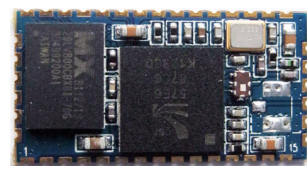

23.3 x 11.93 x 2.0 mm SMT

## RF CHARACTERISTICS:

RF Characteristics @ Core Vdd=1.5V	Min.	Typ.	Max.	Bluetooth Specification	Unit	
Maximum RF transmit power <sup>(a)(b)(c)</sup>	-----	4	-----	-6 to 4 <sup>(d)</sup>	dBm	
RF power variation over temperature range with compensation enabled. <sup>(e)</sup>	----	±0.5	-----	-----	dB	
RF power variation over temperature range with compensation disabled. <sup>(e)</sup>	-----	±2.5	-----	-----	dB	
RF power control range	16	24	-----	≥16	dB	
RF power range control resolution <sup>(f)</sup>	-----	0.5	-----	-----	dB	
20dB bandwidth for modulated carrier	-----	940	1000	≤1000	kHz	
ACP <sup>(g)</sup> (h)	F = Fo ± 2MHz	-----	-36	-20	≤-20	dBm
	F = Fo ±3 MHz	-----	-45	-40	≤-40	dBm
	F = Fo ± > 3MHz	-----	<-50	-40	≤-40	dBm
Δf1avg Maximum modulation	140	165	175	140<f1avg<175	kHz	
Δf2max Minimum modulation	115	142	-----	≥115	kHz	
Δf1avg /Δf2avg	0.80	0.92	-----	≥0.80	-----	
Initial carrier frequency tolerance <sup>(i)</sup>	-75	6	75	±75	kHz	
Drift rate	-----	6	20	≤20	kHz/50μs	
Drift(single slot packet)	-25	8	25	≤25	kHz	
Drift(five slot packet)	-40	10	40	≤40	kHz	
2 <sup>nd</sup> Harmonic content	-----	-32 <sup>(j)</sup>	-----	-----	dBm	
3 <sup>rd</sup> Harmonic content	-----	-32 <sup>(j)</sup>	-----	-----	dBm	

- (a) Results are referenced to the single ended port of the balun.
- (b) The Bluecore5-Multimedia External firmware maintains the transmit power within Bluetooth v2.1 + EDR specification limits.
- (c) Measurement made using appropriate PS Key settings.
- (d) Class 2 RF transmit power range, Bluetooth v2.1 + EDR specification.
- (e) Parameters depend on matching circuit used and behaviour over temperature. These parameters may be beyond CSR's direct control.
- (f) Resolution guaranteed over the range -5dB to -25dB relative to maximum power for TX level > 8dBm.
- (g) Measured at F<sub>0</sub> = 2441MHz.
- (h) BlueCore5-Multimedia External guaranteed to meet ACP performance in Bluetooth v2.1 + EDR specification.
- (i) Ignores any frequency error in the reference.
- (j) Filter will attenuate the harmonics.

# 23.3 x 11.93 x 2.0 mm SMT Bluetooth Module

ABBTM-2.4GHz-52-T



RoHS  
Compliant

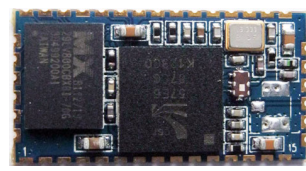

23.3 x 11.93 x 2.0 mm SMT

Ratio Characteristics @ Core Vdd=1.5V		Modulation	Min	Typ	Max	Bluetooth Specification	Unit
Sensitivity at 0.01% BER <sup>(a)</sup>	Ch 0	Π/4 DQPSK	-----	-93	-70	≤-70	dBm
	Ch 39		-----	-93	-70		
	Ch 78		-----	-92	-70		
	Ch 0	8 DPSK	-----	-85	-70	≤-70	dBm
	Ch 39		-----	-85	-70		
	Ch 78		-----	-84	-70		
Maximum received signal at 0.1% BER		Π/4 DQPSK	-20	>-10	----	≥-20	dBm
		8 DPSK	-20	>-10	----	≥-20	dBm
C/I co-channel at 0.1% BER <sup>(b)(c)</sup>		Π/4 DQPSK	-----	10	13	≤13	dB
		8 DPSK	-----	18	21	≤21	dB
Adjacent channel selectivity C/I <sup>(b)(c)</sup>	F=F <sub>0</sub> + 1 MHz	Π/4 DQPSK	-----	-9	0	≤0	dB
		8 DPSK	-----	-2	5	≤5	dB
	F=F <sub>0</sub> - 1 MHz	Π/4 DQPSK	-----	-10	0	≤0	dB
		8 DPSK	-----	-5	5	≤5	dB
	F=F <sub>0</sub> + 2 MHz	Π/4 DQPSK	-----	-25	-20	≤-20	dB
		8 DPSK	-----	-22	-13	≤-13	dB
	F=F <sub>0</sub> - 2 MHz	Π/4 DQPSK	-----	-41	-30	≤-30	dB
		8 DPSK	-----	-34	-25	≤-25	dB
	F=F <sub>0</sub> - 3 MHz	Π/4 DQPSK	-----	-46	-40	≤-40	dB
		8 DPSK	-----	-38	-33	≤-33	dB
	F=F <sub>0</sub> + 5 MHz	Π/4 DQPSK	-----	-48	-40	≤-40	dB
		8 DPSK	-----	-41	-33	≤-33	dB
F= F <sub>image</sub>	Π/4 DQPSK	-----	-12	-7	≤-7	dB	
	8 DPSK	-----	-12	0	≤0	dB	

(a) Dirty transmitter used.

(b) BlueCore5-Multimedia External is guaranteed to meet the C/I performance as specified by the Bluetooth v2.1 + EDR RF Test specification.

(c) Measured at F<sub>0</sub> = 2441MHz. However, depending on crystal frequency and channel number, then image may switch to the opposite side of the carrier. When this occurs, F<sub>image</sub> = F<sub>0</sub> - 3MHz and the offsets in the table equations associated with C/I are also reversed.

# 23.3 x 11.93 x 2.0 mm SMT Bluetooth Module

ABBTM-2.4GHz-52-T



**RoHS**  
Compliant

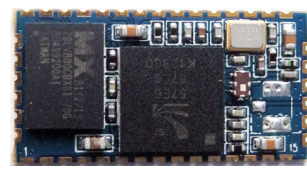

23.3 x 11.93 x 2.0 mm SMT

## Firmware Configuration

- a) UART Baud: 115200 , N, 8, 1
- b) BlueTooth Name: BlueAudio
- c) Pin Code: 0000

## Software Description

1. After Power on 3V3, the module is connectable and Pairing
2. ABBTM-2.4GHz-52-T can be found with the name “BlueAudio” via any Bluetooth device
3. Input the Pincode “0000”, you can pair with the module named “BlueAudio”
4. Then the BlueAudio can be connected
5. Data can be transferred between the BlueAudio and any other Bluetooth device



# 23.3 x 11.93 x 2.0 mm SMT Bluetooth Module

ABBTM-2.4GHz-52-T



RoHS  
Compliant

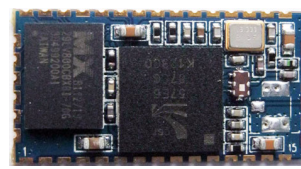

23.3 x 11.93 x 2.0 mm SMT

## APPLICATION SCHEMATIC

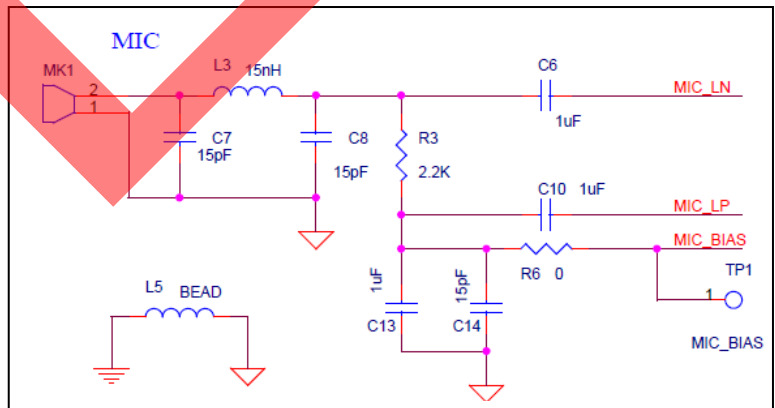
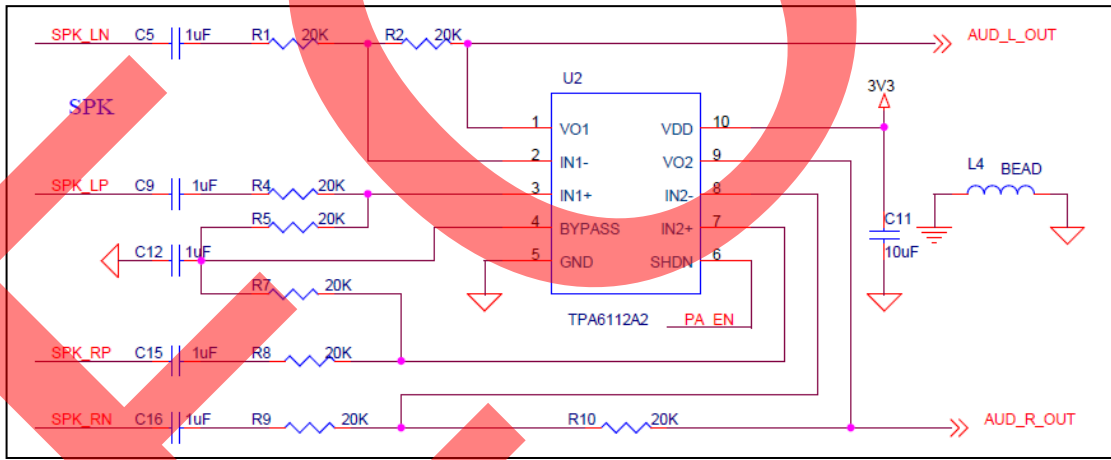
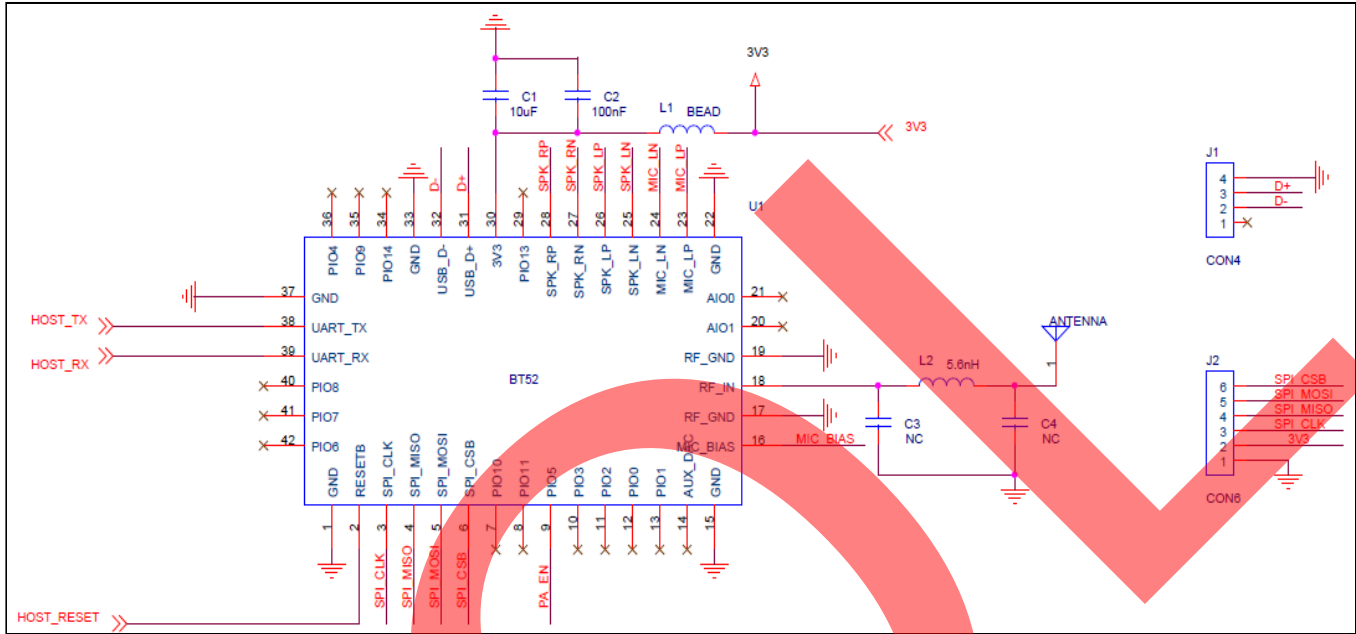

ABRACON IS  
ISO 9001:2008  
CERTIFIED



Visit [www.abracon.com](http://www.abracon.com) for Terms & Conditions of Sale  
30332 Esperanza, Rancho Santa Margarita, California 92688  
tel 949-546-8000 | fax 949-546-8001 | [www.abracon.com](http://www.abracon.com)

Revised: 01.14.15

# 23.3 x 11.93 x 2.0 mm SMT Bluetooth Module

ABBTM-2.4GHz-52-T



RoHS  
Compliant

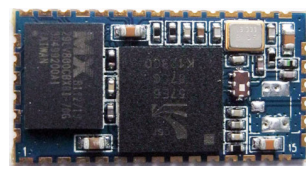

23.3 x 11.93 x 2.0 mm SMT

## MECHANICAL DIMENSIONS

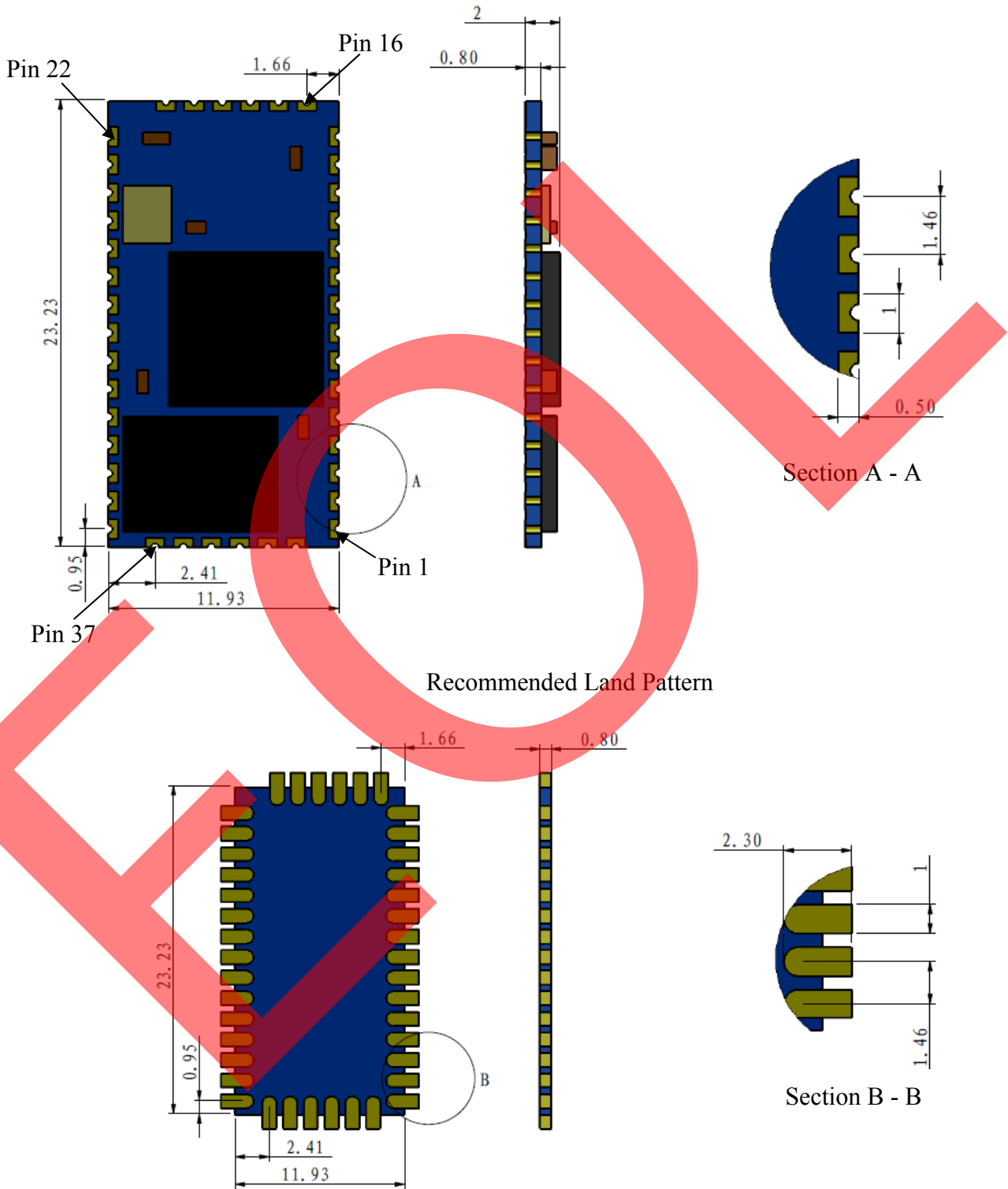

Note: Specified dimensions without tolerance are listed for reference purposes only. Dimensions: mm.



# 23.3 x 11.93 x 2.0 mm SMT Bluetooth Module

ABBTM-2.4GHz-52-T



RoHS  
Compliant

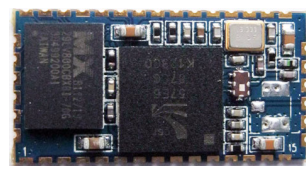

23.3 x 11.93 x 2.0 mm SMT

## PIN DESCRIPTION

Pin No.	Name	Type	Function
1	GND	Ground	Ground
2	RESETB	CMOS Input with weak internal pull-up	Reset if low. Input debounced so must be below for >5ms to cause a reset
3	SPI_CLK	Input with weak internal pull-down	Serial Peripheral Interface clock
4	SPI_MISO	CMOS Output, tri-state, with weak internal pull-down	Serial Peripheral Interface output
5	SPI_MOSI	CMOS Input with weak internal pull-down	Serial Peripheral Interface input
6	SPI_CSB	CMOS Input with weak internal pull-up	Chip select for Synchronous Serial Interface active low
7	PIO10	Bi-directional with programmable strength internal pull-up/down	Programmable input/output line
8	PIO11	Bi-directional with programmable strength internal pull-up/down	Programmable input/output line
9	PIO5	Bi-directional with programmable strength internal pull-up/down	Programmable input/output line
10	PIO3	Bi-directional with programmable strength internal pull-up/down	Programmable input/output line
11	PIO2	Bi-directional with programmable strength internal pull-up/down	Programmable input/output line
12	PIO0	Bi-directional with programmable strength internal pull-up/down	Programmable input/output line
13	PIO1	Bi-directional with programmable strength internal pull-up/down	Programmable input/output line
14	AUX_DAC	Analogue	Voltage DAC output
15	GND	Ground	Ground
16	MIC_BIAS	Analogue	Microphone Bias
17	RF_GND	RF Ground	RF Ground
18	RF_IN	Analogue	Transceiver input/output line
19	RF_GND	RF Ground	RF Ground
20	AIO1	Bi-directional	Analogue Programmable input/output
21	AIO0	Bi-directional	Analogue Programmable input/output
22	GND	Ground	Ground
23	MIC_LP	Analogue	Microphone input positive
24	MIC_LN	Analogue	Microphone input negative
25	SPK_LN	Analogue	Speaker output negative(left side)
26	SPK_LP	Analogue	Speaker output positive(left side)
27	SPK_RN	Analogue	Speaker output negative(right side)
28	SPK_RP	Analogue	Speaker output positive(right side)
29	PIO13	Bi-directional with programmable strength internal pull-up/down	Programmable input/output line
30	3V3	3.3v power input	3.3v power input
31	N.C.	Not Connected	
32	N.C.	Not Connected	
33	GND	Ground	Ground
34	PIO14	Bi-directional with programmable strength internal pull-up/down	Programmable input/output line
35	PIO9	Bi-directional with programmable strength internal pull-up/down	Programmable input/output line
36	PIO4	Bi-directional with programmable strength internal pull-up/down	Programmable input/output line
37	GND	Ground	Ground
38	UART_TX	Bi-directional CMOS Output, tri-state, with weak internal pull-up	UART data output
39	UART_RX	CMOS Input with weak internal pull-down	UART data input
40	PIO8	Bi-directional with programmable strength internal pull-up/down	Programmable input/output line
41	PIO7	Bi-directional with programmable strength internal pull-up/down	Programmable input/output line
42	PIO6	Bi-directional with programmable strength internal pull-up/down	Programmable input/output line



# 23.3 x 11.93 x 2.0 mm SMT Bluetooth Module

ABBTM-2.4GHz-52-T



RoHS  
Compliant

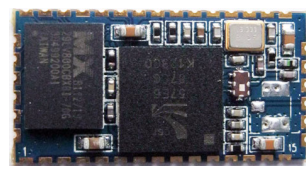

23.3 x 11.93 x 2.0 mm SMT

## REFLOW PROFILE

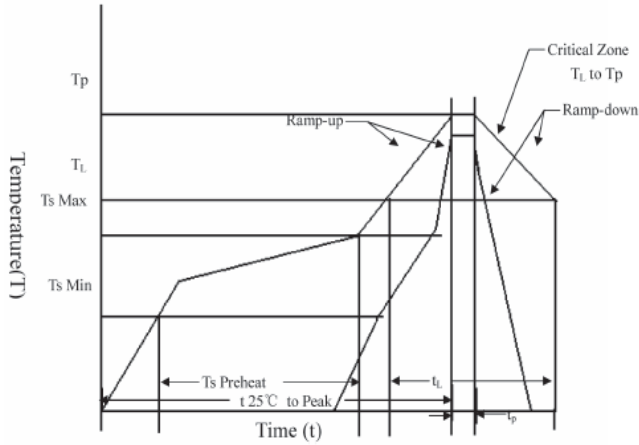

$T_s$ max to $T_l$ (Ramp-up Rate)	3°C/second max.
Preheat	
Temperature Min. ( $T_s$ Min.)	150°C
Temperature Typical ( $T_s$ Typ.)	175°C
Temperature Max. ( $T_s$ Max.)	200°C
Time ( $t_s$ )	60 ~ 180 seconds
Ramp-up rate ( $T_l$ to $T_p$ )	3°C/second max.
Time Maintained Above:	
--Temperature ( $T_l$ )/Time ( $T_l$ )	217°C/60 ~ 150 seconds
Peak Temperature ( $T_p$ )	250°C max. for 10 seconds
Target Peak Temperature ( $T_p$ Target)	250°C +0/-5°C
Time within 5°C of actual peak ( $t_p$ )	20 ~ 40 seconds
Ramp-down Rate	6°C/second max.
Tune 25°C to Peak Temperature (t)	8 minutes max.

## PACKAGING:

500pcs/reel

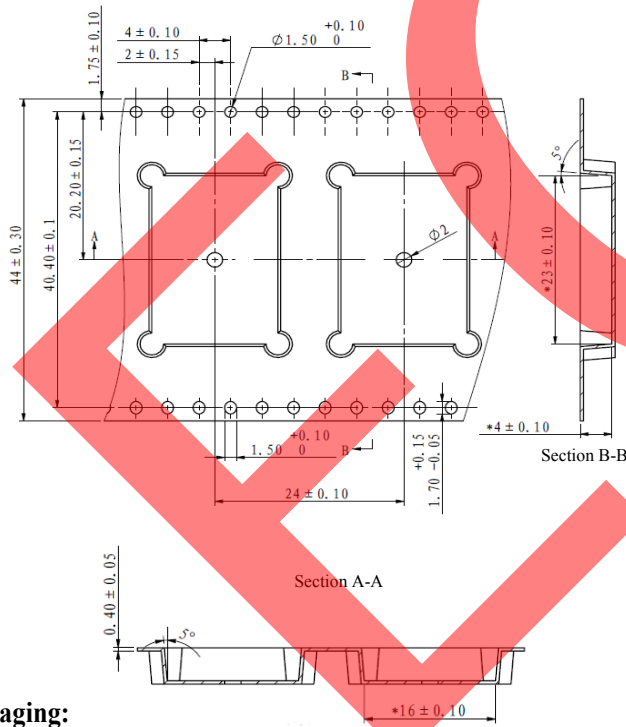

包装要求:  
500 pcs/Reel

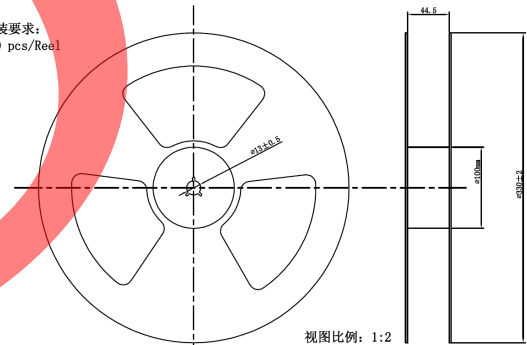

- Unless otherwise specified, the tolerance is  $\pm 0.1$ mm
- The carrier tape material thickness is 0.4mm
- Unless otherwise specified, the round corner is R0.3; the peeling angle is no greater than  $5^\circ$
- The finished products has no rough edges and no damage; cover tape should be sealed
- Material is ROHS compliant

### Packaging:

ABBTM-2.4GHz-52-T devices will be packaged per MSL level-3 requirements; Labeled as MSL 3, Tape- Packed + Vacuum-Packed with Antistatic bag, Desiccant, Humidity Indicator Card (HIC). Ref: IPC/JEDEC J-STD-033B.1

**ATTENTION:** Abracon Corporation's products are COTS – Commercial-Off-The-Shelf products; suitable for Commercial, Industrial and, where designated, Automotive Applications. Abracon's products are not specifically designed for Military, Aviation, Aerospace, Life-dependant Medical applications or any application requiring high reliability where component failure could result in loss of life and/or property. For applications requiring high reliability and/or presenting an extreme operating environment, written consent and authorization from Abracon Corporation is required. Please contact Abracon Corporation for more information.

ABRACON IS  
ISO 9001:2008  
CERTIFIED



Visit [www.abracon.com](http://www.abracon.com) for Terms & Conditions of Sale  
30332 Esperanza, Rancho Santa Margarita, California 92688  
tel 949-546-8000 | fax 949-546-8001 | [www.abracon.com](http://www.abracon.com)

Revised: 01.14.15