

GTLP1B151

1-Bit LVTTTL/GTLP Transceiver with Separate LVTTTL Port and Feedback Path

General Description

The GTLP1B151 is a 1-bit transceiver that provides LVTTTL-to-GTLP signal level translation. Individual LVTTTL and GTLP driver enables are also available. The GTLP1B151 offers separate LVTTTL inputs and outputs, and can provide a feedback path for control and diagnostics monitoring.

High-speed backplane operation is a direct result of GTLP's reduced output swing (<1V), reduced input threshold levels and output edge rate control. The edge rate control minimizes bus-settling time. GTLP is a Fairchild Semiconductor derivative of the Gunning Transistor Logic (GTL) JEDEC standard JESD8-3.

Fairchild's GTLP has internal edge-rate control and is process, voltage and temperature compensated. GTLP's I/O structure is similar to GTL and BTL but offers different output levels and receiver threshold. Typical GTLP output voltage levels are: $V_{OL} = 0.5V$, $V_{OH} = 1.5V$, and $V_{REF} = 1V$.

Features

- Separate LVTTTL inputs and outputs
- A feedback path for control and diagnostics monitoring
- Bidirectional interface between GTLP and LVTTTL logic levels
- Designed with edge rate control circuitry to reduce output noise on the GTLP port
- V_{REF} pin provides external supply reference voltage for receiver threshold adjustability
- Special PVT compensation circuitry to provide consistent performance over variations of process, supply voltage and temperature
- TTL compatible driver and control inputs
- Designed using Fairchild advanced BiCMOS technology
- Bushold data inputs on A port to eliminate the need for external pull-up resistors for unused inputs
- Power up/down and power off high impedance for live insertion
- Open drain on GTLP to support wired-or connection
- Flow through pinout optimizes PCB layout
- A Port source/sink -24mA / +24mA
- B Port sink +50mA

Ordering Code:

Order Number	Package Number	Package Description
GTLP1B151M	M08A	8-Lead Small Outline Integrated Circuit (SOIC), JEDEC MS-012, 0.150" Narrow [TUBE]
GTLP1B151MX	M08A	8-Lead Small Outline Integrated Circuit (SOIC), JEDEC MS-012, 0.150" Narrow [TAPE and REEL]
GTLP1B151K8X	MAB08A (Preliminary)	8-Lead US8, JEDEC MO-187, Variation CA 3.1mm Wide [TAPE and REEL]

Pin Descriptions

Pin Names	Description
OEB, $\overline{\text{OEC}}$	LVTTL Individual Output Enable Controls (OEC is Active LOW)
V_{CC} , GND, V_{REF}	Device Supplies
A	A Port LVTTL Input
B	B Port GTLP Input/Output
C	C Port LVTTL Output

Connection Diagrams

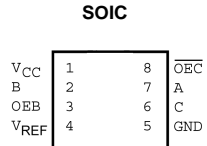
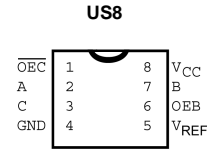

Functional Description

The GTLP1B151 is a 1-bit transceiver that supports GTLP and LVTTL signal levels. Data polarity is non-inverting with separate LVTTL inputs and outputs and there are individual GTLP and LVTTL output enable controls.

Functional Tables

Inputs				Outputs		Description
OEB	$\overline{\text{OEC}}$	A_n	B_n	B_n	C_n	
H	L	L	Output	L	L	B Bus Enabled, C Bus Enabled
H	L	H	Output	H	H	B Bus Enabled, C Bus Enabled
H	H	L	Output	L	Z	B Bus Enabled, C Bus Disabled
H	H	H	Output	H	Z	B Bus Enabled, C Bus Disabled
L	H	L	L	Z	Z	B Bus Disabled, C Bus Disabled
L	H	H	H	Z	Z	B Bus Disabled, C Bus Disabled
L	L	N/A	L	Z	L	B Bus Disabled, C Bus Enabled
L	L	N/A	H	Z	H	B Bus Disabled, C Bus Enabled

Logic Diagram

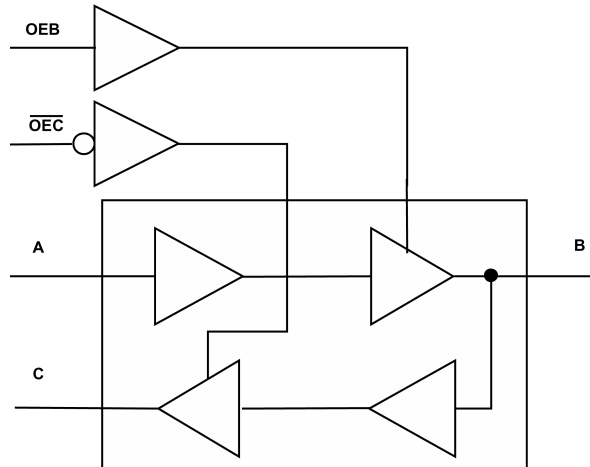

Absolute Maximum Ratings ^(Note 1)		Recommended Operating Conditions	
Supply Voltage (V_{CC})	-0.5V to +4.6V	Supply Voltage V_{CC}	3.15V to 3.45V
DC Input Voltage (V_I)	-0.5V to +4.6V	Bus Termination Voltage (V_{TT})	
DC Output Voltage (V_O)		GTLP	1.47V to 1.53V
Outputs 3-STATE	-0.5V to +4.6V	V_{REF}	0.98V to 1.02V
Outputs Active (Note 2)	-0.5V to +4.6V	Input Voltage (V_I)	
DC Output Sink Current into		on A Port and Control Pins	0.0V to V_{CC}
C Port I_{OL}	48 mA	HIGH Level Output Current (I_{OH})	
DC Output Source Current from		C Port	-24 mA
C Port I_{OH}	-48 mA	LOW Level Output Current (I_{OL})	
DC Output Sink Current into		C Port	+24 mA
B Port in the LOW State, I_{OL}	100 mA	B Port	+50 mA
DC Input Diode Current (I_{IK})		Operating Temperature (T_A)	-40°C to +85°C
$V_I < 0V$	-50 mA		
DC Output Diode Current (I_{OK})			
$V_O < 0V$	-50 mA		
ESD Rating	>2000V		
Storage Temperature (T_{STG})	-65°C to +150°C		

Note 1: Absolute Maximum Ratings are those values beyond which the safety of the device cannot be guaranteed. The device should not be operated at these limits. The parametric values defined in the "Electrical Characteristics" table are not guaranteed at the absolute maximum rating. The "Recommended Operating Conditions" table will define the conditions for actual device operation.

Note 2: I_O Absolute Maximum Rating must be observed.

DC Electrical Characteristics

Over Recommended Operating Free-Air Temperature Range, $V_{REF} = 1.0V$ (unless otherwise noted).

Symbol	Test Conditions		Min	Typ (Note 3)	Max	Units
V_{IH}	B Port		$V_{REF} + 0.05$		V_{TT}	V
	Others		2.0			
V_{IL}	B Port		0.0		$V_{REF} - 0.05$	V
	Others				0.8	
V_{REF}	B Port		0.7V	1.0	1.3V	V
V_{TT}	B Port		$V_{REF} + 50\text{ mV}$	1.5	V_{CC}	V
V_{IK}		$V_{CC} = 3.15V$	$I_I = -18\text{ mA}$		-1.2	V
V_{OH}	C Port	$V_{CC} = \text{Min to Max (Note 4)}$	$I_{OH} = -100\text{ }\mu\text{A}$	$V_{CC} - 0.2$		V
		$V_{CC} = 3.15V$	$I_{OH} = -8\text{ mA}$	2.4		
			$I_{OH} = -24\text{ mA}$	2.2		
V_{OL}	C Port	$V_{CC} = \text{Min to Max (Note 4)}$	$I_{OL} = 100\text{ }\mu\text{A}$		0.2	V
		$V_{CC} = 3.15V$	$I_{OL} = 8\text{ mA}$		0.4	
		$V_{CC} = 3.15V$	$I_{OL} = 24\text{ mA}$		0.5	
	B Port	$V_{CC} = 3.15V$	$I_{OL} = 40\text{ mA}$		0.4	V
		$I_{OL} = 50\text{ mA}$		0.55		
I_I	Control Pins	$V_{CC} = 3.45V$	$V_I = 3.45V$ $V_I = 0V$		5 -5	μA
	A Port	$V_{CC} = 3.45V$	$V_I = 3.45V$ $V_I = 0V$		10 -10	
	B Port	$V_{CC} = 3.45V$	$V_I = 3.45$ $V_I = 0$		5 -5	
I_{OFF}	A or C Ports, Control Pins	$V_{CC} = 0$	V_I or $V_O = 0$ to 3.45V		30	μA
	B Port	$V_{CC} = 0$	V_I or $V_O = 0$ to 3.45V		30	
$I_I(\text{HOLD})$	A Port	$V_{CC} = 3.15V$	$V_I = 0.8V$ $V_I = 2.0V$	75	-75	μA
I_{OZH}	C Port	$V_{CC} = 3.45V$	$V_O = 3.45V$		10	μA
	B Port		$V_O = 3.45V$		5	
I_{OZL}	C Port	$V_{CC} = 3.45V$	$V_O = 0V$		-10	μA
	B Port		$V_O = 0.0V$		-5	

DC Electrical Characteristics (Continued)

Symbol	Test Conditions	Min	Typ (Note 3)	Max	Units
$I_{PU/PD}$	All Ports $V_{CC} = 0$ to 1.5V	$V_I = 0$ to 3.45V		30	μA
I_{CC}	A or B Ports or C Port $I_O = 0$ $V_I = V_{CC}/V_{TT}$ or GND	Outputs HIGH		11	mA
		Outputs LOW		11	
		Outputs Disabled		11	
ΔI_{CC} (Note 5)	A Port and Control Pins A or Control Inputs at V_{CC} or GND	One Input at V_{CC} -0.6V		2	mA
C_i	Control Pins and A Port	$V_I = V_{CC}$ or 0		3	pF
C_O	C Port	$V_I = V_{CC}$ or 0		5	pF
$C_{I/O}$	B Port	$V_I = V_{TT}$ or 0		5.5	pF

Note 3: All typical values are at $V_{CC} = 3.3V$ and $T_A = 25^\circ C$.

Note 4: For conditions shown as Min, use the appropriate value specified under recommended operating conditions.

Note 5: This is the increase in supply current for each input that is at the specified TTL voltage level rather than V_{CC} or GND.

Note: GTLP V_{REF} and V_{TT} are specified to 2% tolerance since signal integrity and noise margin can be significantly degraded if these supplies are noisy. In addition, V_{TT} and R_{TERM} can be adjusted beyond the recommended operating to accommodate backplane impedances other than 50 Ω , but must remain within the boundaries of the DC Absolute Maximum Ratings. Similarly, V_{REF} can be adjusted to optimize noise margin.

AC Electrical Characteristics

Over recommended range of supply voltage and operating free-air temperature, $V_{REF} = 1.0V$ (unless otherwise noted).
 $C_L = 30$ pF for B Port and $C_L = 50$ pF for C Port.

Symbol	From (Input)	To (Output)	Min	Typ (Note 6)	Max	Unit
t_{PLH} t_{PHL}	A	B	1.2 0.8	3.2 2.3	7.3 4.5	ns
t_{PLH} t_{PHL}	B	C	1.4 1.6	2.8 2.9	4.4 5.0	ns
t_{PLH} t_{PHL}	A	C	1.6 2.0	6.0 5.1	8.1 7.5	ns
t_{RISE}	Transition Time, B Outputs (20% to 80%)			1.4		ns
t_{FALL}	Transition Time, B Outputs (80% to 20%)			2.0		ns
t_{RISE}	Transition Time, C Outputs (10% to 90%)			2.8		ns
t_{FALL}	Transition Time, C Outputs (90% to 10%)			2.5		ns
t_{PZH} , t_{PZL} t_{PHZ} , t_{PLZ}	\overline{OEC}	C	1.2 1.4	2.7 2.8	5.3 4.9	ns
t_{PLH} t_{PHL}	OEB	B	1.7 0.5	3.5 2.2	5.9 4.7	ns

Note 6: All typical values are at $V_{CC} = 3.3V$, and $T_A = 25^\circ C$.

Test Circuits and Timing Waveforms

Test Circuit for C Outputs

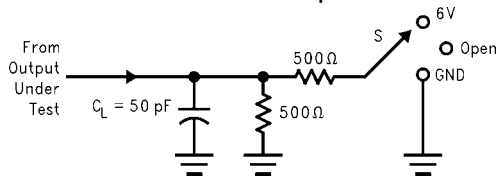

Test	S
t_{PLH}/t_{PHL}	OPEN
t_{PLZ}/t_{PZL}	6V
t_{PHZ}/t_{PZH}	GND

Note: C_L includes probes and Jig capacitance.

Test Circuit for B Outputs

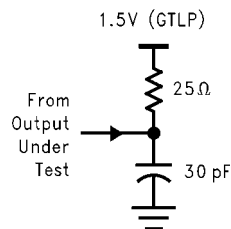

Note: C_L includes probes and Jig capacitance.

Note: For B Port, $C_L = 30$ pF is used for worst case.

Voltage Waveforms Propagation Delay

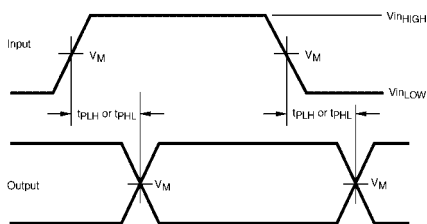

Voltage Waveform Enable and Disable Times

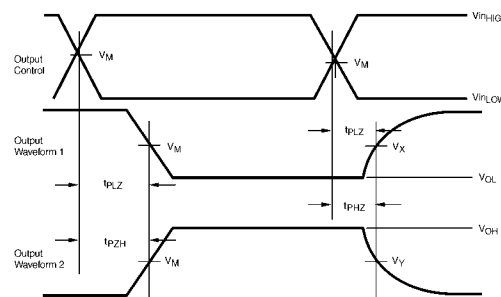

	A or LVTTL Pins	B or GTLP Pins
V_{INHIGH}	V_{CC}	1.5
V_{INLOW}	0.0	0.0
V_M	$V_{CC}/2$	1.0
V_X	$V_{OL} + 0.3V$	N/A
V_Y	$V_{OH} - 0.3V$	N/A

Note: Waveform 1 is for an output with internal conditions such that the output is LOW except when disabled by the output control.

Waveform 2 is for an output with internal conditions such that the output is HIGH except when disabled by the output control.

Note: All input pulses have the following characteristics:

Frequency = 10MHz, $t_{RISE} = t_{FALL} = 2$ ns (10% to 90%), $Z_O = 50\Omega$. The outputs are measured one at a time with one transition per measurement.

Physical Dimensions inches (millimeters) unless otherwise noted

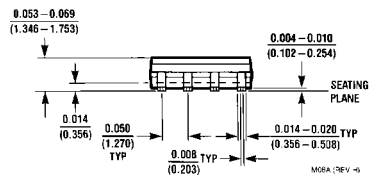
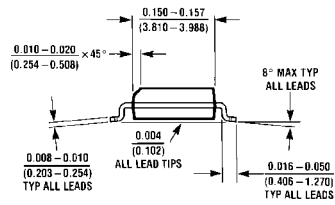
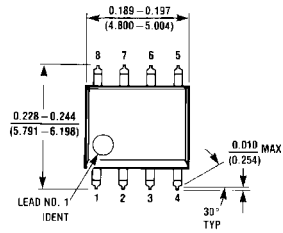

8-Lead Small Outline Integrated Circuit (SOIC), JEDEC MS-012, 0.150" Narrow Package Number M08A

Physical Dimensions inches (millimeters) unless otherwise noted (Continued)

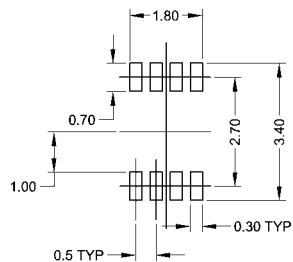
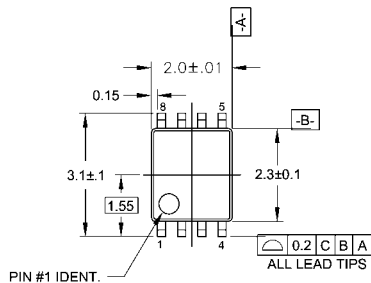

LAND PATTERN RECOMMENDATION

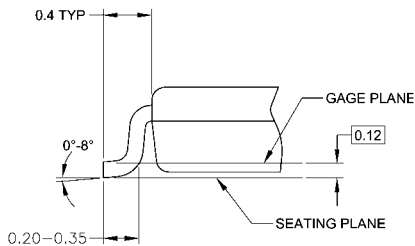
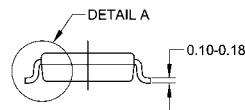
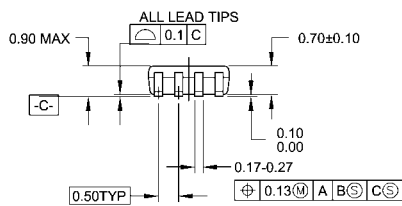

DETAIL A

NOTES:

- A. CONFORMS TO JEDEC REGISTRATION MO-187
- B. DIMENSIONS ARE IN MILLIMETERS.
- C. DIMENSIONS ARE EXCLUSIVE OF BURRS, MOLD FLASH, AND TIE BAR EXTRUSIONS.
- D. DIMENSIONS AND TOLERANCES PER ANSI Y14.5M, 1982.

MAB08AREVC

**8-Lead US8, JEDEC MO-187, Variation CA 3.1mm Wide
Package Number MAB08A
Preliminary**

Fairchild does not assume any responsibility for use of any circuitry described, no circuit patent licenses are implied and Fairchild reserves the right at any time without notice to change said circuitry and specifications.

LIFE SUPPORT POLICY

FAIRCHILD'S PRODUCTS ARE NOT AUTHORIZED FOR USE AS CRITICAL COMPONENTS IN LIFE SUPPORT DEVICES OR SYSTEMS WITHOUT THE EXPRESS WRITTEN APPROVAL OF THE PRESIDENT OF FAIRCHILD SEMICONDUCTOR CORPORATION. As used herein:

1. Life support devices or systems are devices or systems which, (a) are intended for surgical implant into the body, or (b) support or sustain life, and (c) whose failure to perform when properly used in accordance with instructions for use provided in the labeling, can be reasonably expected to result in a significant injury to the user.
2. A critical component in any component of a life support device or system whose failure to perform can be reasonably expected to cause the failure of the life support device or system, or to affect its safety or effectiveness.

www.fairchildsemi.com