

General Specifications

Electrical Capacity (Resistive Load)

Power Level: 1mA @ 5.5V DC (resistive load)

Other Ratings

XY Resistive Value: 250 ~ 850Ω; Wide: 120 ~ 1,500Ω

Linearity: ±1.5% maximum

Insulation Impedance: 10MΩ minimum @ 25V DC

Expected Operational Life: Writing: 50,000 operations minimum (approximately 30mm movement with stylus)
Tapping: 1,000,000 operations minimum (pressing force 4.9N using silicone rubber, hardness 60°)

Touch Activation Force: 0.02 ~ 1.0N maximum

Chattering Time: 10 milliseconds maximum

Light Transmission: 80% typical (Touch Panel portion)

Surface Hardness: 3H minimum (JIS K5400)

Environmental Data

Operating Temperature Range: -20°C ~ +70°C (-4°F ~ +158°F)

Storage Temperature Range: -40°C ~ +80°C (-40°F ~ +176°F)

Relative Humidity: +40°C (+104°F), humidity 90%, 240 hours

TYPICAL TOUCH SCREEN ORDERING EXAMPLE

TP01

104A

4

K

Screen Size & Aspect Ratio

104A	10.4"
106W	10.6"
121A	12.1"
121W	12.1"
150A	15.0"
156W	15.6"
190A	19.0"

Note: Aspect Ratio
Code A = 4:3
Code W = 16:9

Type

4 | 4-Wire Analog

Operation

K | Light Touch

Package Options

No Code	Touch Screen Only
B	* Touch Screen & Controller Board
C	* Touch Screen & IC Chip

* Controller boards & IC chips for Multi-Touch Screens available only with package options.

DESCRIPTION FOR TYPICAL ORDERING EXAMPLE

TP01 104A-4K

Touch Screen with
10.4" Screen



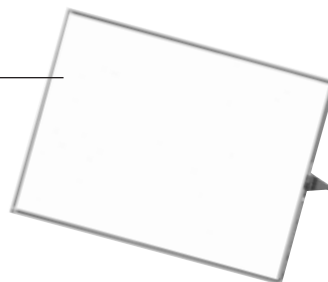



Finger or Stylus Input



Horizontal Tail Position

4-Wire Analog

PART NUMBERS & DESCRIPTIONS

			
TP01104A-4K	TP01106W-4K	TP01121A-4K	TP01121W-4K
			
TP01150A-4K	TP01156W-4K	TP01190A-4K	

4-Wire Analog Touch Screens

Tail	Part Number	Screen Size in Inches	Key Area Dimensions	Viewing Area Dimensions	External Dimensions	Panel Thickness	Terminal Detail 4 Pin .039" (1.0mm) Pitch
Aspect Ratio 4:3 Horizontal Tail	TP01104A-4K	10.4	8.315" x 6.236" (211.2mm x 158.4mm)	8.465" x 6.394" (215.0mm x 162.4mm)	8.882" x 6.748" (225.6mm x 171.4mm)	.083" (2.1mm)	Length 3.150" (80.0mm)
	TP01121A-4K	12.1	9.677" x 7.256" (245.8mm x 184.3mm)	9.827" x 7.406" (249.6mm x 188.1mm)	10.236" x 7.795" (260.0mm x 198.0mm)	.083" (2.1mm)	Length 3.150" (80.0mm)
	TP01150A-4K	15.0	11.972" x 8.980" (304.1mm x 228.1mm)	12.130" x 9.138" (308.1mm x 232.1mm)	12.669" x 9.665" (321.8mm x 245.5mm)	.083" (2.1mm)	Length 3.059" (77.7mm)
	TP01190A-4K	19.0	14.815" x 11.850" (376.3mm x 301.0mm)	15.039" x 12.102" (382.0mm x 307.4mm)	15.571" x 12.638" (395.5mm x 321.0mm)	.083" (2.1mm)	Length 3.150" (80.0mm)
Aspect Ratio 16:9 Wide Frame with Horizontal Tail	TP01106W-4K	10.6	9.071" x 5.441" (230.4mm x 138.2mm)	9.189" x 5.563" (233.4mm x 141.3mm)	9.756" x 6.094" (247.8mm x 154.8mm)	.083" (2.1mm)	Length 3.150" (80.0mm)
	TP01121W-4K	12.1	10.280" x 6.425" (261.12mm x 163.2mm)	10.404" x 6.551" (264.26mm x 166.4mm)	10.827" x 6.929" (275.0mm x 176.0mm)	.083" (2.1mm)	Length 3.150" (80.0mm)
	TP01156W-4K	15.6	13.551" x 7.618" (344.2mm x 193.5mm)	13.681" x 7.748" (347.5mm x 196.8mm)	14.276" x 8.433" (362.6mm x 214.2mm)	.083" (2.1mm)	Length 3.150" (80.0mm)

TYPICAL 10.4 DIMENSIONS

Horizontal Tail

Aspect Ratio 4:3

Tail Detail

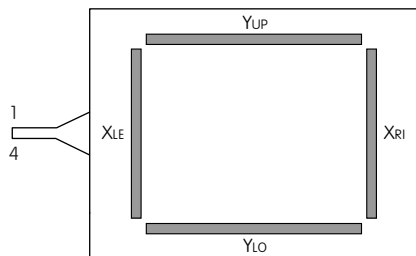
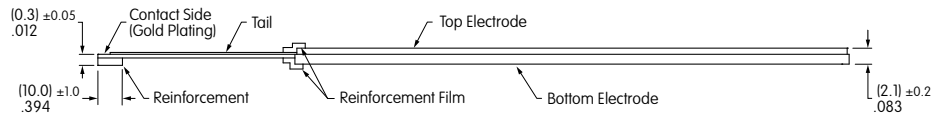
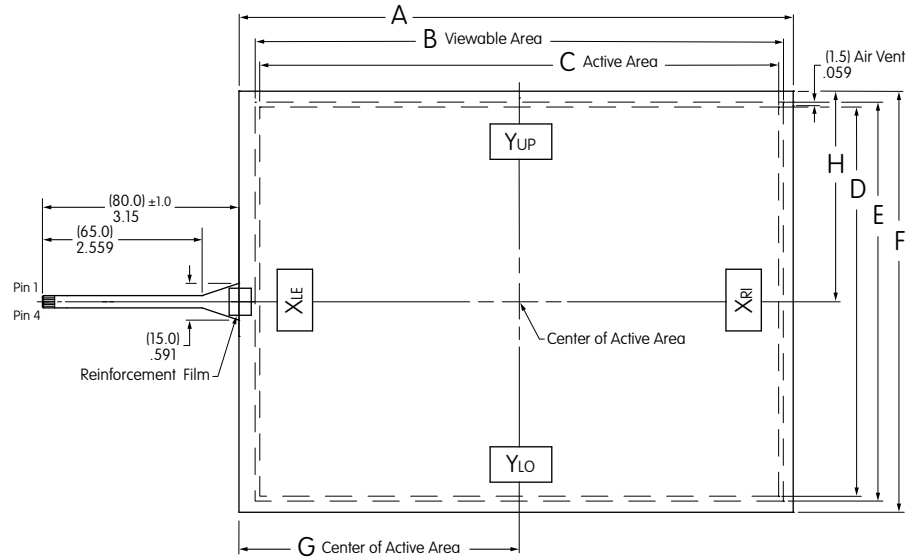
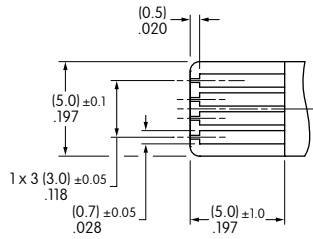

Pins	Signal
1	Y _{UP}
2	Y _{LO}
3	X _{LE}
4	X _{RI}

Y_{UP}, Y_{LO}: Bottom Electrode Terminal
X_{LE}, X_{RI}: Top Electrode Terminal

Typical Dimensions

Part Number	Screen Size in Inches	Dim A	Dim B Viewable Area	Dim C Active Area	Dim D Active Area	Dim E Viewable Area	Dim F	Dim G Center of Active Area (Horizontal)	Dim H Center of Active Area (Vertical)
TP01104A-4K	10.4	8.882" (225.6 ±0.3mm)	8.465" (215.0mm)	8.315" (211.2mm)	6.236" (158.4mm)	6.394" (162.4mm)	6.748" (171.4 ±0.3mm)	4.492" (114.1mm)	3.374" (85.7mm)

TYPICAL 12.1 DIMENSIONS

4-Wire with Horizontal Tail

Aspect Ratio 4:3

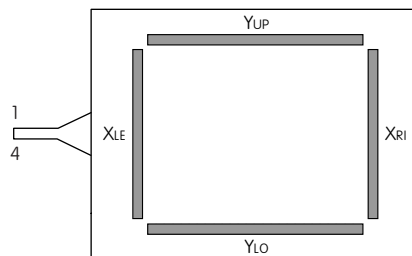
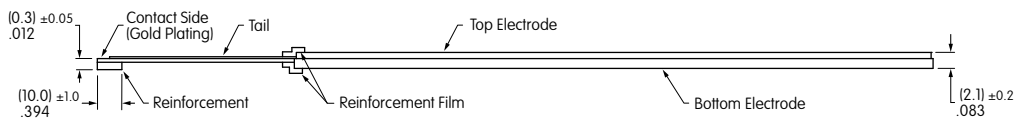
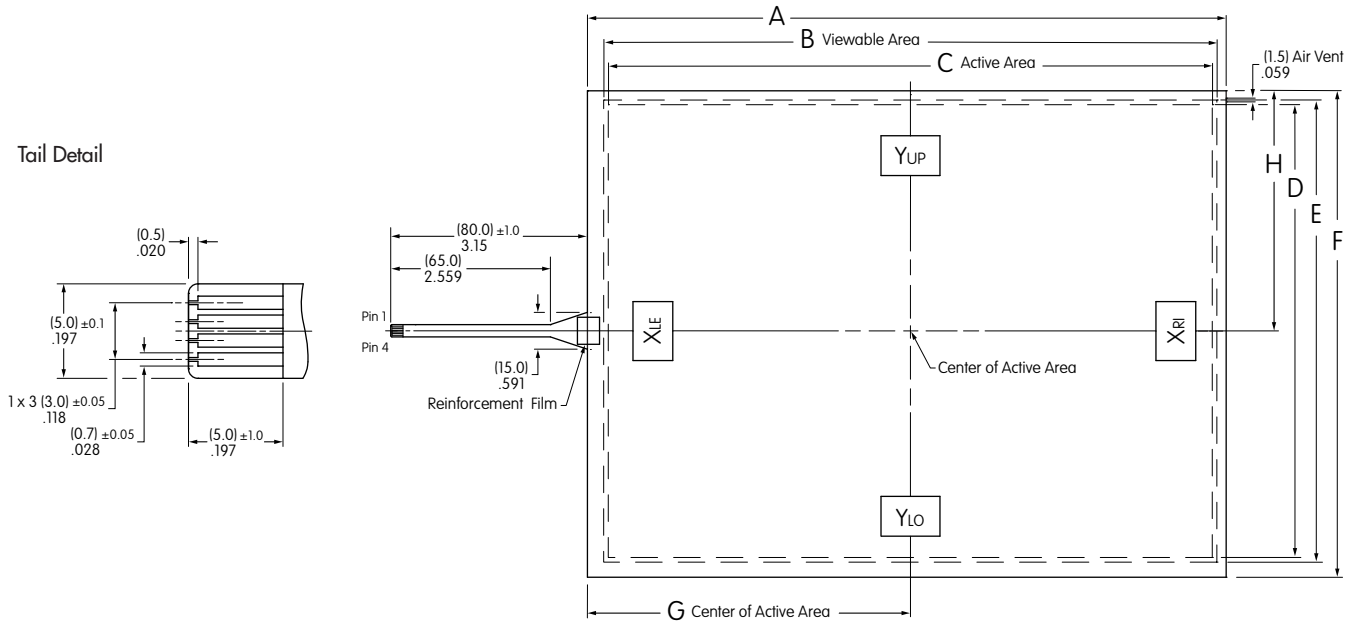

YUP, YLO: Bottom Electrode Terminal
XLE, XRI: Top Electrode Terminal

Pins	Signal
1	Y _{UP}
2	Y _{LO}
3	X _{LE}
4	X _{RI}

Typical Dimensions

Part Number	Screen Size in Inches	Dim A	Dim B Viewable Area	Dim C Active Area	Dim D Active Area	Dim E Viewable Area	Dim F	Dim G Center of Active Area (Horizontal)	Dim H Center of Active Area (Vertical)
TP01121A-4K	12.1	10.236" (260.0±0.3mm)	9.827" (249.6mm)	9.677" (245.8mm)	7.256" (184.3mm)	7.406" (188.1mm)	7.795" (198.0±0.3mm)	5.177" (131.5mm)	3.850" (97.8mm)

TYPICAL 15.0 DIMENSIONS

4-Wire with Horizontal Tail

Aspect Ratio 4:3

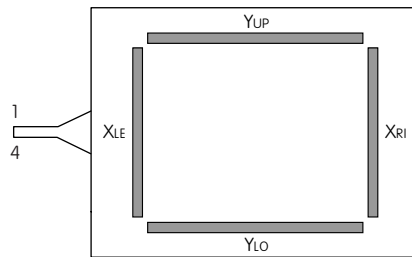
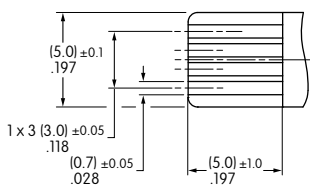
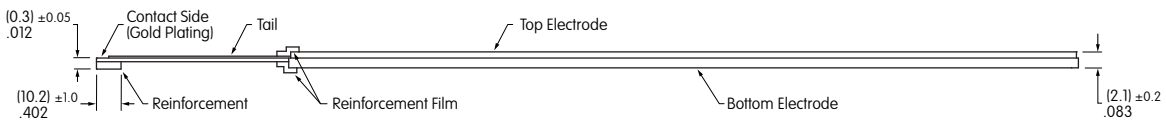
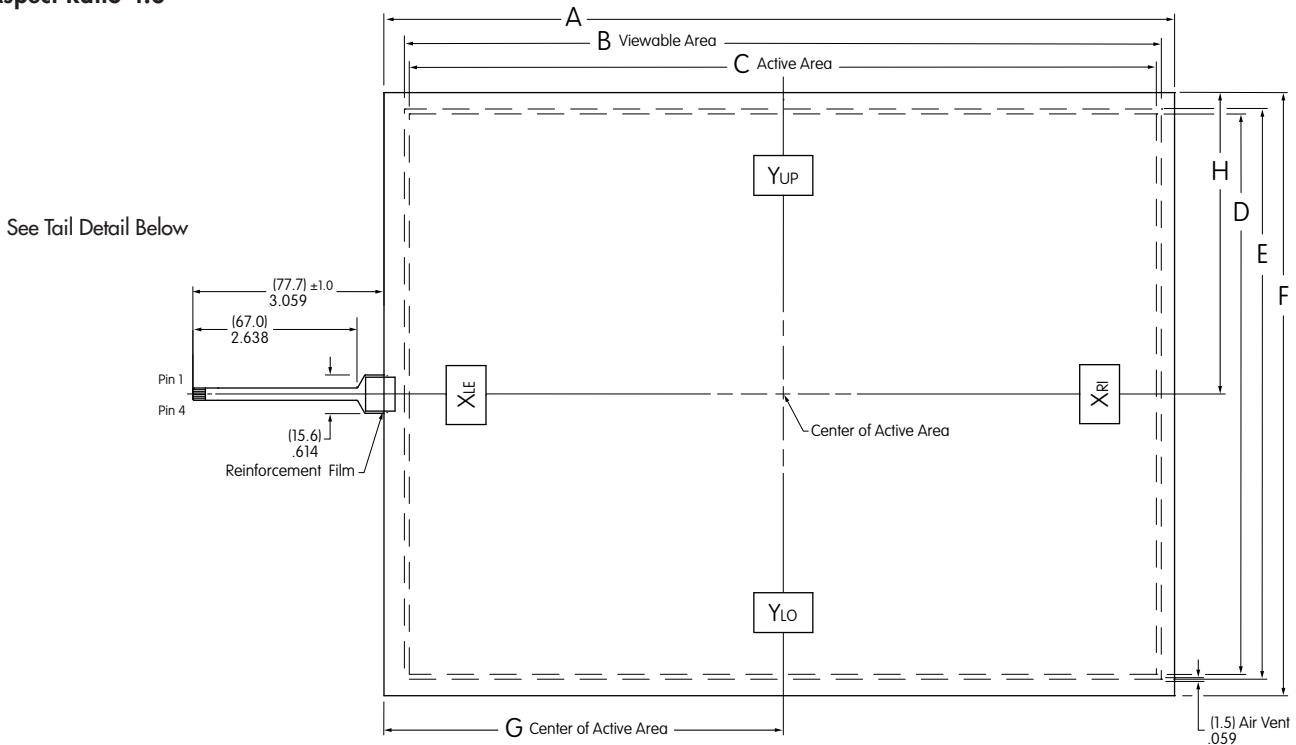

YUP, YLO: Bottom Electrode Terminal
XLE, XRI: Top Electrode Terminal

Pins	Signal
1	Y _{UP}
2	Y _{LO}
3	X _{LE}
4	X _{RI}

Typical Dimensions

Part Number	Screen Size in Inches	Dim A	Dim B Viewable Area	Dim C Active Area	Dim D Active Area	Dim E Viewable Area	Dim F	Dim G Center of Active Area (Horizontal)	Dim H Center of Active Area (Vertical)
TP01150A-4K	15.0	12.669" (321.8±0.3mm)	12.130" (308.1mm)	11.972" (304.1mm)	8.980" (228.1mm)	9.138" (232.1mm)	9.665" (245.5±0.3mm)	6.398" (162.5mm)	4.833" (122.75mm)

TYPICAL 19.0 DIMENSIONS

4-Wire with Horizontal Tail

Aspect Ratio 4:3

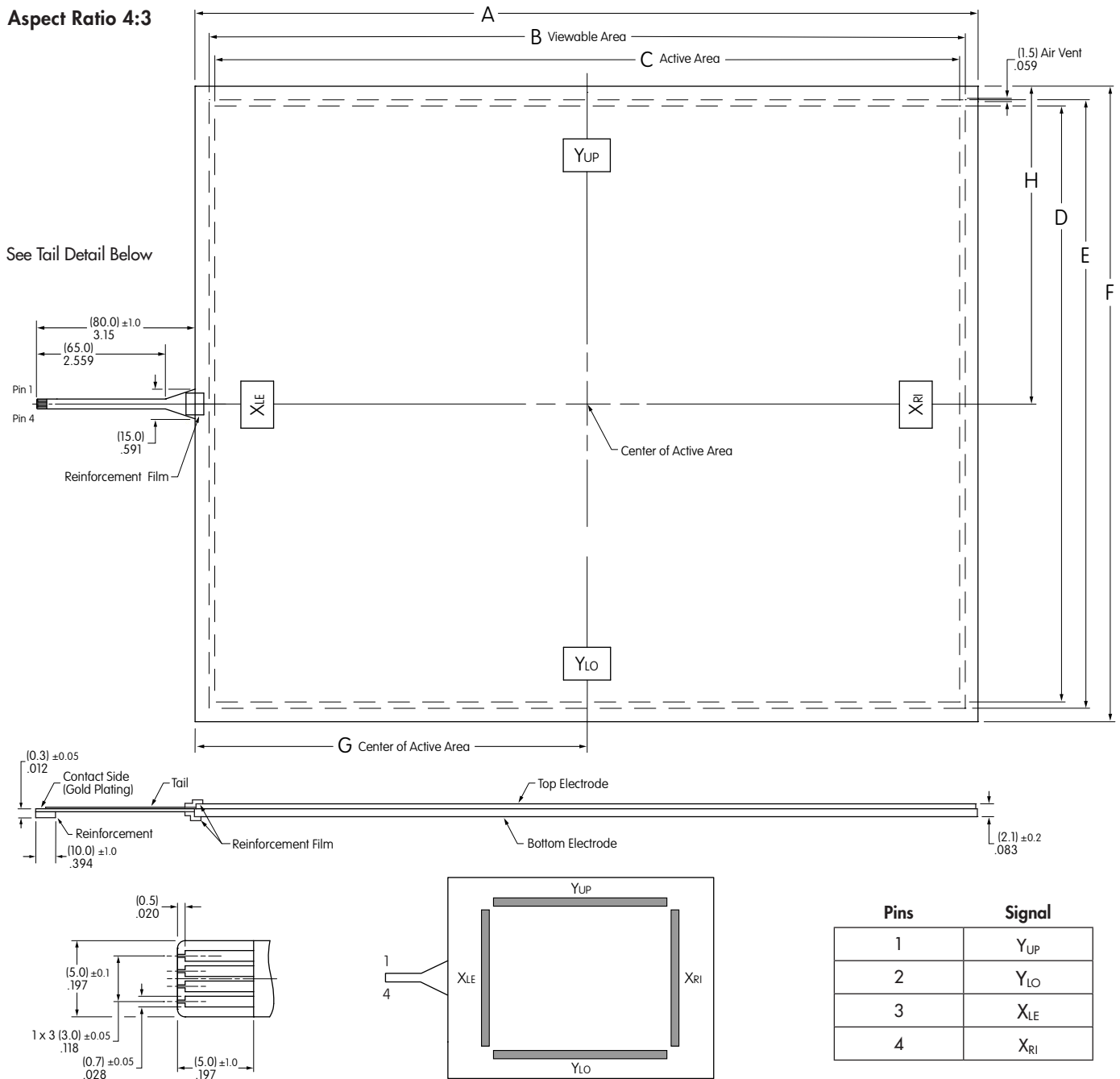

Y_{UP}, Y_{LO}: Bottom Electrode Terminal
X_{LE}, X_{RI}: Top Electrode Terminal

Typical Dimensions

Part Number	Screen Size in Inches	Dim A	Dim B Viewable Area	Dim C Active Area	Dim D Active Area	Dim E Viewable Area	Dim F	Dim G Center of Active Area (Horizontal)	Dim H Center of Active Area (Vertical)
TP01190A-4K	19.0	15.571" (395.5±0.3mm)	15.039" (382.0mm)	14.815" (376.3mm)	11.850" (301.0mm)	12.102" (307.4mm)	12.638" (321.0±0.3mm)	7.799" (198.1mm)	6.319" (160.5mm)

TYPICAL 10.6 DIMENSIONS

Horizontal Tail & Wide Frame

Aspect Ratio 16:9

Tail Detail

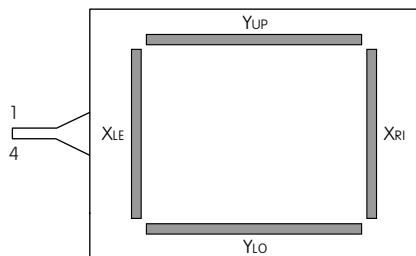
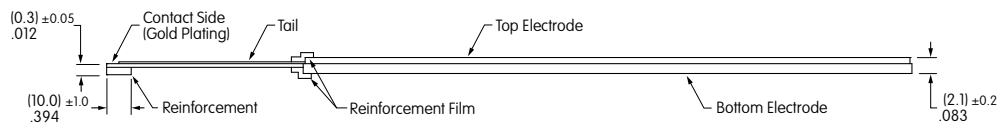
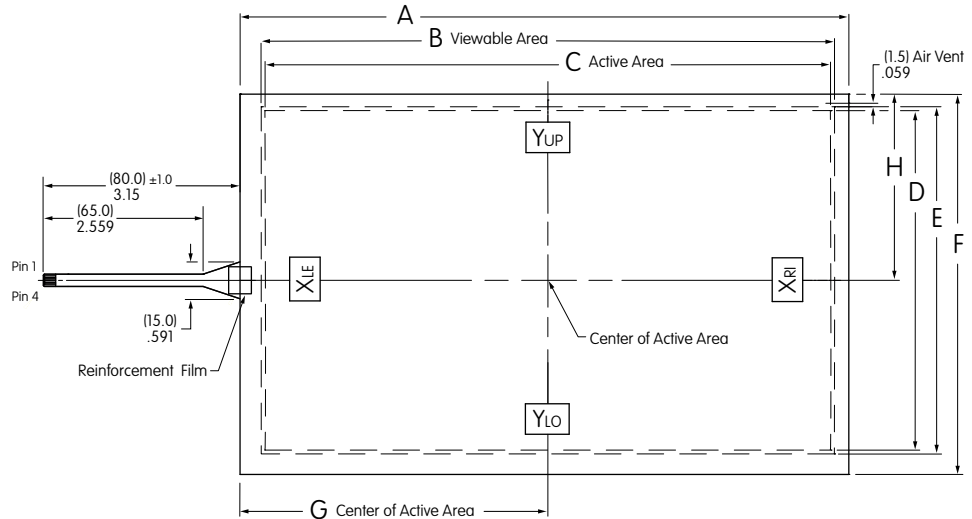
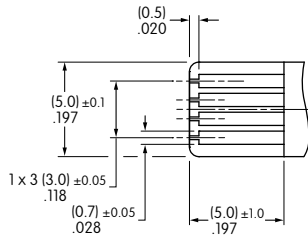

Pins	Signal
1	Y _{UP}
2	Y _{LO}
3	X _{LE}
4	X _{RI}

Y_{UP}, Y_{LO}: Bottom Electrode Terminal
X_{LE}, X_{RI}: Top Electrode Terminal

Typical Dimensions

Part Number	Screen Size in Inches	Dim A	Dim B Viewable Area	Dim C Active Area	Dim D Active Area	Dim E Viewable Area	Dim F	Dim G Center of Active Area (Horizontal)	Dim H Center of Active Area (Vertical)
TP01106W-4K	10.6	9.756" (247.8mm)	9.189" (233.4mm)	9.071" (230.4mm)	5.441" (138.2mm)	5.563" (141.3mm)	6.094" (154.8±0.3mm)	4.933" (125.3mm)	2.984" (75.8mm)

TYPICAL 12.1 DIMENSIONS

4-Wire Wide Type with Horizontal Tail

Aspect Ratio 16:9

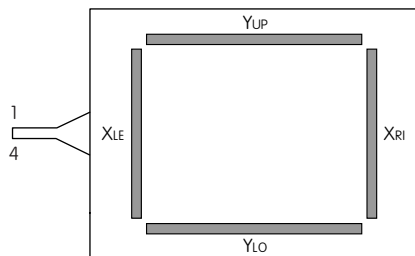
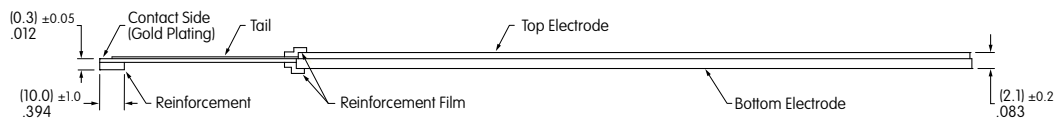
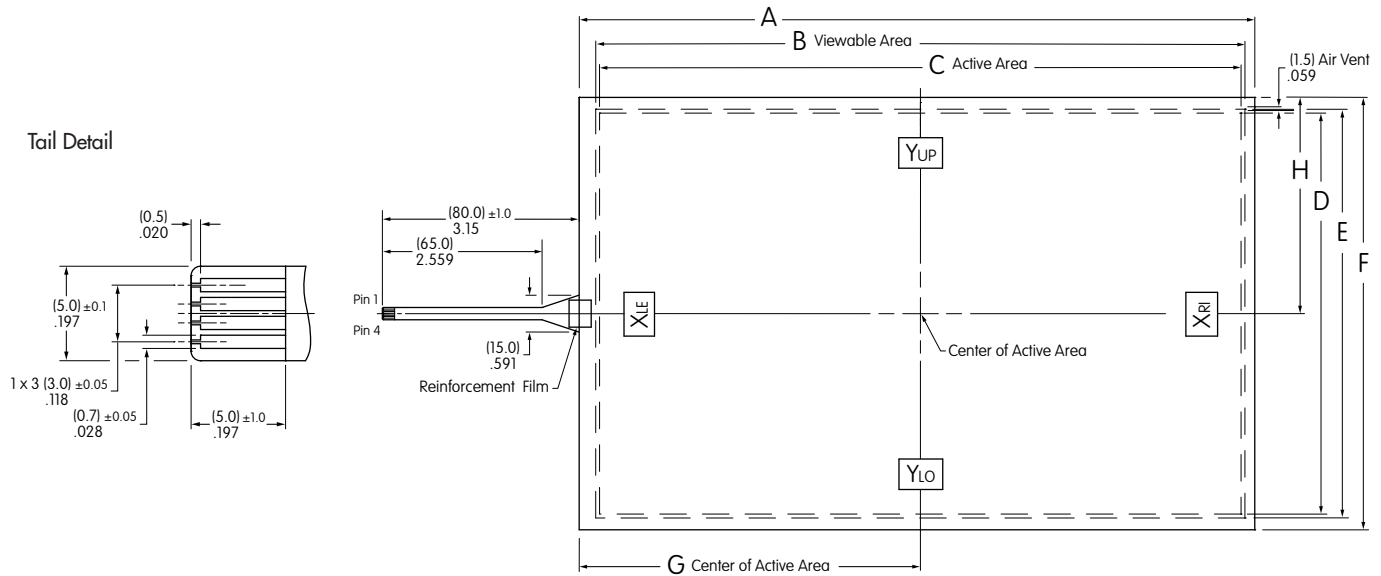

YUP, YLO: Bottom Electrode Terminal
XLE, XRI: Top Electrode Terminal

Pins	Signal
1	Y _{UP}
2	Y _{LO}
3	X _{LE}
4	X _{RI}

Typical Dimensions

Part Number	Screen Size in Inches	Dim A	Dim B Viewable Area	Dim C Active Area	Dim D Active Area	Dim E Viewable Area	Dim F	Dim G Center of Active Area (Horizontal)	Dim H Center of Active Area (Vertical)
TP01121W-4K	12.1	10.827" (275.0±0.3mm)	10.404" (264.26mm)	10.280" (261.12mm)	6.425" (163.2mm)	6.551" (166.4mm)	6.929" (176.0±0.3mm)	5.468" (138.89mm)	3.465" (88.0mm)

TYPICAL 15.6 DIMENSIONS

4-Wire Wide Type with Horizontal Tail

Aspect Ratio 16:9

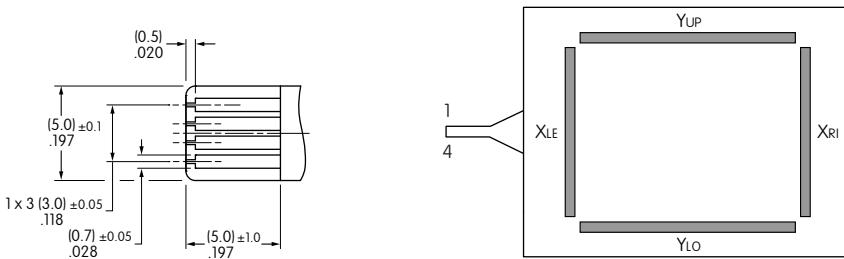
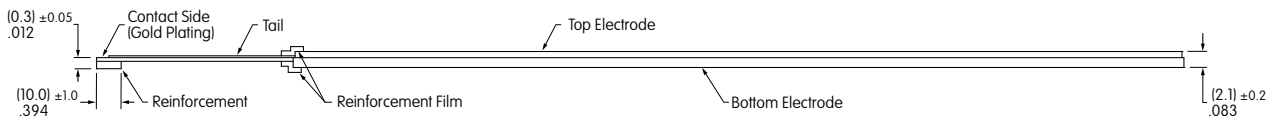
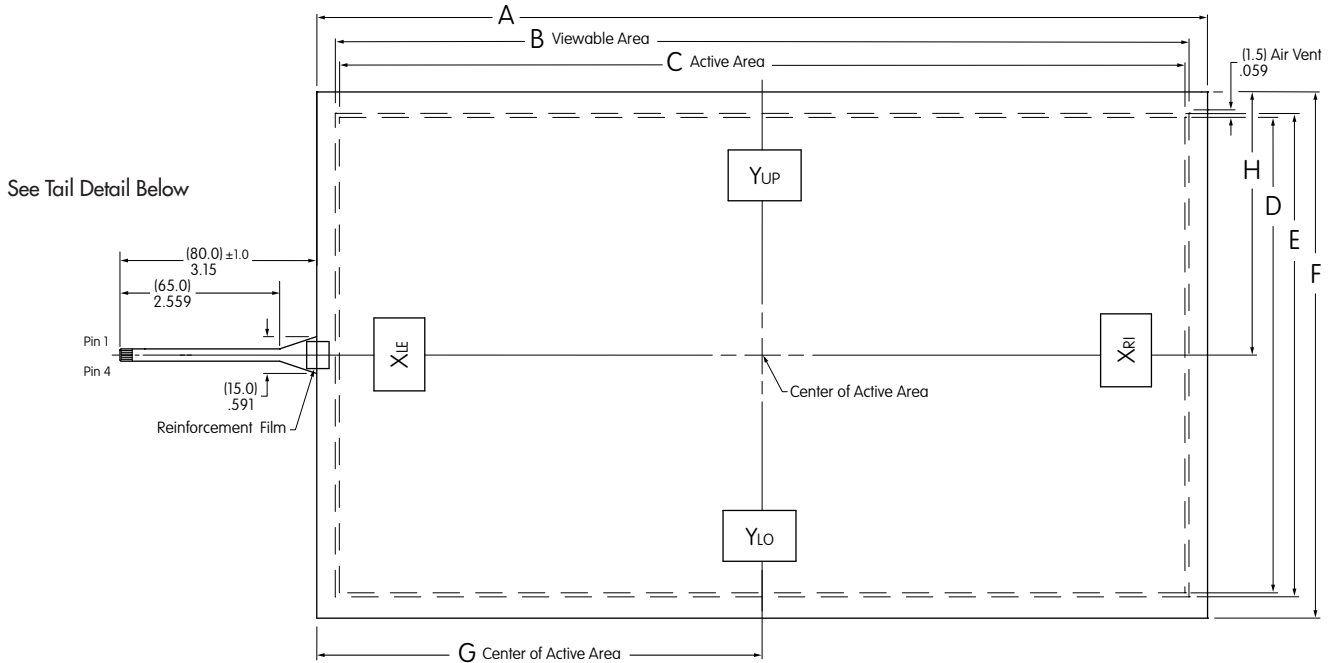

YUP, YLO: Bottom Electrode Terminal
XLE, XRI: Top Electrode Terminal

Pins	Signal
1	Y _{UP}
2	Y _{LO}
3	X _{LE}
4	X _{RI}

Typical Dimensions

Part Number	Screen Size in Inches	Dim A	Dim B Viewable Area	Dim C Active Area	Dim D Active Area	Dim E Viewable Area	Dim F	Dim G Center of Active Area (Horizontal)	Dim H Center of Active Area (Vertical)
TP01 156AW-4	15.6	14.276" (362.6±0.3mm)	13.681" (347.5mm)	13.551" (344.2mm)	7.618" (193.5mm)	7.748" (196.8mm)	8.433" (214.2±0.3mm)	7.138" (181.3mm)	4.217" (107.1mm)

4-Wire Multi-Touch Screen Controller Boards & Drivers

DISTINCTIVE CHARACTERISTICS

- Compatible with Controller Board USB
- Device Driver is *Windows 7, 8 & 10 Compatible

System Configuration for USB

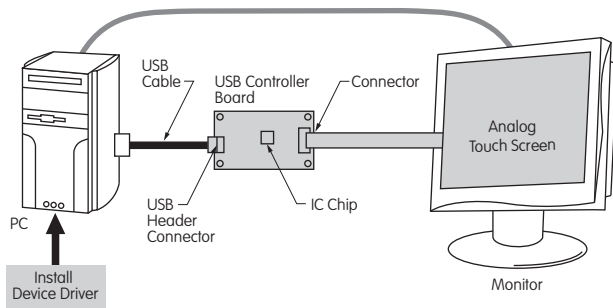

■ Available through NKK Switches

Absolute Maximum Ratings

Items	Symbols	Minimum	Maximum
Supply Voltage	V_{CC}	+4.5V	+5.5V
Input Voltage	V_{TP}	—	V_{CC}
Operating Temperature	T_{OPR}	-20°C (-4°F)	+70°C (+158°F)
Storage Temperature	T_{STG}	-30°C (-22°F)	+85°C (+185°F)

Controller Boards		
Type	Part No.	Communication Protocol
4-Wire	* TP01104A-4KB	USB

* Includes any of the TP01 Multi-Touch Screen models. Controller boards are not sold separately, but in a package with any of the TP01 screen sizes.

NKK's analog touch panels can be operated the same as PC mouse functions by combining a controller board or device driver and analog touch screen. This includes the screen's multi-touch capabilities.

For specifications or technical data for the controller boards and drivers, see NKK's web site or call our engineering support personnel.

NKK offers the option to order a controller board in a package with a touch screen. See ordering table for details.

Recommended Values

Items	Symbols	Minimum	Typical	Maximum	Notes
Supply Voltage	V_{CC}	+4.5V	+5	+5.5V	—
Operating Temperature	T_{OPR}	-20°C (-4°F)	—	+70°C (+158°F)	No Condensation

IC Chip for Analog Multi-Touch Screens

DISTINCTIVE CHARACTERISTICS

- Interface: USB
- Compatible with * Windows 7, 8 & 10
- High Speed and Accuracy
- Built-in Calibration Function
- Data Function Removal Built In to Eliminate Noise

The IC is for use with the 4-wire transparent touch screens. When the screen is touched, it recognizes the position of the touch by the level of analog voltage detected by the A/D. The A/D converter receives the value and sends a set of coordinate values as serial data or USB.

Contact NKK Switches for the IC data sheet.

NKK offers the option to order an IC chip in a package with a touch screen. See ordering table for details.

* Windows is a registered trademark of Microsoft Corporation.

4-Wire Multi-Touch Screen Controller Board for USB

Controller Board for USB

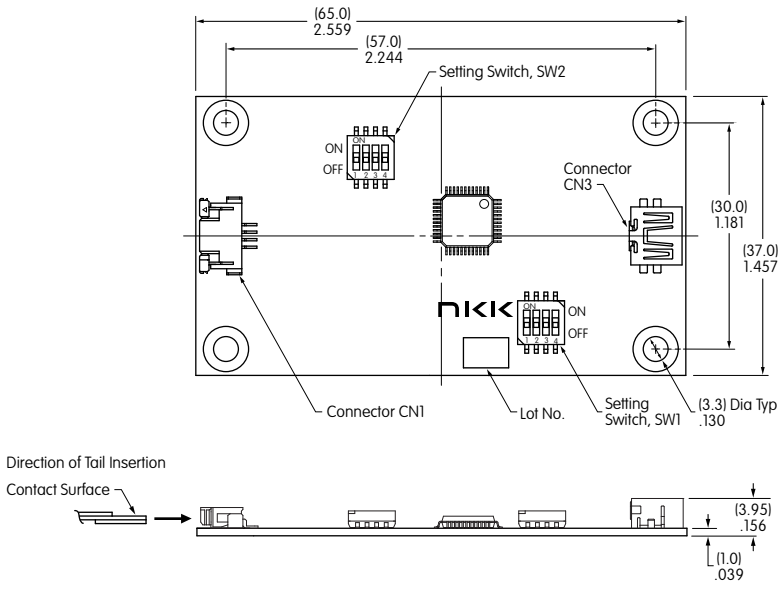

CN1 4-Wire Analog Touch Screen Connector - 4 Pins

Pin No.	Symbol	Description
1	Y _{UP}	Touch Screen Drive Output PSW2
2	Y _{LO}	Touch Screen Drive Output PSW1, PSW5
3	X _{LE}	Touch Screen Drive Output PSW4
4	X _{RI}	Touch Screen Drive Output PSW3, PSW6

CN3 Header Connector for USB - 5 Pins

Pin No.	Symbol	Description
1	V _{CC}	V _{CC}
2	D ₋	D ₋
3	D ₊	D ₊
4	GND	V _{SS} (OV)
5	FG	Shield GND

ANALOG TOUCH SCREENS

1. The analog touch screen has a two-layer structure consisting of polyester film with an ITO membrane and sheet of glass. The surfaces of top and bottom electrodes have a uniform resistive film. One electrode draws in the X-axis direction, the other on the Y-axis direction. When pressure is applied, it changes the resistance value between X1 and X2 and Y1 and Y2, then converts to a digital signal.

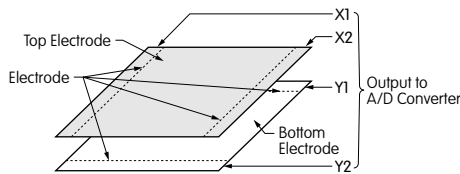

2. To interpret the touched position, 5V is applied to the top electrode (X1 and X2). Then the voltage on the arrow direction evenly changes.

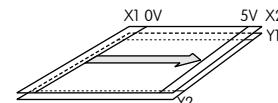

3. With a touch to the center of the top electrode film, the touched position contacts the bottom film (glass), and 2.5V is output to Y1 (or Y2). The output signal is then converted to a digital signal and can be recognized as an X-axis coordinate value. In the same way, the Y-axis coordinate value can be read from Y1 and Y2 on the bottom electrode. Then the position where the X and Y axis coordinate value intersected is read as the contact position.

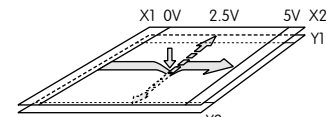

4. The resolution of the analog touch screens is relatively higher than the digital models and contributes to the variety of the screen designs available, including those displaying buttons. Since analog types generally detect signals as a point but not as a number on the keys, the signals may be input as text or drawings with a pen. The vertical and horizontal resolution (detection points) is 1,024 when a 10bit A/D converter is used.

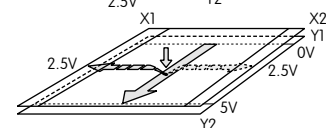

The active area of each button is independent of each other, resulting in no interference between the areas.

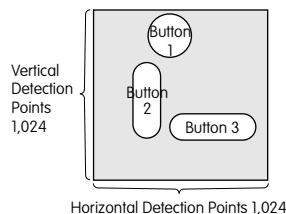

STORAGE, HANDLING & INSTALLATION

Handling of Controller Board

- Use arc prevention to protect device from static electricity.
- Power source should be activated after host and touch panel are connected.
- When inserting connector CN1 and touch panel tail, be sure the slider of connector CN1 is pulled. Do not pull more than 10 times.
- Do not alter the product.
- Do not use any commands other than the ones outlined in the specifications.
- Place the product away from noise source (such as inverter from LCD operation) since tail can be affected by noise.
- If device driver (USB) does not work after installation, reboot the host computer while connected to the controller board.
- Warranty for one year after delivery. NKK warranties the 4-wire touch panel when it is used with the NKK control board and driver. Do not use third party control boards. NKK is not responsible for results of using damaged equipment with the controller boards.
- NKK Switches cannot assume responsibility for damages caused by software side during use of the touch screens.
- The touch screen pressed position may shift depending on various factors such as age, improper tail insertion or extreme temperatures. In such cases, recalibration is necessary.

Installation

- Products are ESD sensitive and ESD protection is required.
- Do not pull on the tail. Do not apply stress to the tail area.
- Avoid vibration or shock. Avoid any force or stress that may cause deformation to the product.
- The touch screen mounting should not be loose. This may cause an adverse effect on detecting performance during operation.
- Ensure there are no burrs around the edges of the case or housing that can cause false actuation. The edges of the case or housing should not enter the keying area.

- The case or housing and upper electrode should have a space of about 0.5mm to accommodate expansion or shrinkage due to temperature variances. If a shock barrier is used, do not press hard on the upper electrode area. Any shock barrier should be installed more than 0.6mm away from A.

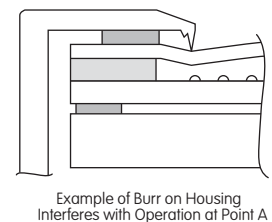
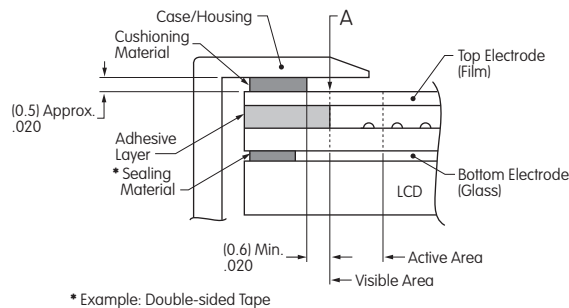

- To secure the touch screen, secure the lower portion with a device such as the LCD display panel. Do not attach the upper electrode with double-sided tape or similar product to avoid stress that can damage the upper or lower electrode.
- In order to balance upper and lower pressure, an air vent may be installed. Ensure that no liquid or oil will enter into the device.
- Avoid air pressure applied to the touch screen as it may cause the top electrode to force air through the air vent, effecting electric endurance. If pressure inside of the touch panel is reduced through the air vent, it may cause interference fringes or may remain in ON status.
- Ensure that the glass is handled carefully to prevent breakage during installation.
- Moisture from condensation on tail connection or edges may result in migration, causing short circuit failure.
- Remove protective film from the touch screen after installation is completed.

STORAGE, HANDLING & INSTALLATION

Handling Precautions

- When opening product, take precaution with up/down and front/back directions. Glass edges are not chamfered, and corners or edges can be sharp. Wear gloves when handling the product.
- Do not pick up the product by the tail or pull the tail area.
- Use gloves or finger cots to prevent fingerprints on surface.
- When handling the product, hold it outside of the viewing area.
- Avoid stacking multiple products or placing other items on the product.
- When packing or storing, the glass should be positioned face up.

Operating Precautions

- Operate with fingers or a touch screen stylus only.
- Do not press hard with a pen or similar object between viewing area and key area.

Design Precautions

- With analog type, resistive value change (by aging or individual differences) can dislocate the input area. Input area can be calibrated with software.
- When installing on top of an LCD, noise from the display device can create misoperation. To avoid noise, implement grounding the display device frame.
- Do not create software for simultaneous touch points, as analog type will read the center point between two touch points.
- When used to draw a line, analog type will have a break at dot spacer. Compensate for this with software.
- Contact resistance may cause chatter depending on pressing condition. Software should detect signal after it stabilizes.

Other Precautions

- Clean with a soft cloth and ethanol. Do not use any cleaning agents other than ethanol.
- Store product in original package and store at the temperature and humidity range specified.
- Do not store in an environment with acids or other corrosive gases or where condensation may occur.
- Products are guaranteed based on evaluation of standards within the moisture tolerance and usage temperature range, but not guaranteed to operate perpetually at this temperature.
- Note that an incorrect type of connector may damage the print surface.
- Calibration data from one touch panel should not be applied to another panel; each should be calibrated individually.
- Recalibration is necessary if connector has been removed from the tail and reconnected.
- All specifications based on the tested touch screens only. Evaluate the products after installation with customer's equipment.
- NKK Switches reserves the right to make product improvement changes without notice.