

DH0034 High Speed Dual Level Translator

General Description

The DH0034 is a high speed level translator suitable for interfacing to MOS or junction FET analog switches. It may also be used as a universal logic level shifter capable of accepting TTL/DTL input levels and shifting to CML, MOS, or SLT levels.

Features

- Fast switching, t_{pd0} : typically 15 ns; t_{pd1} : typically 35 ns
- Large output voltage range: 25V
- Input is TTL/DTL compatible
- Low output leakage: typically 0.1 μ A

Schematic and Connection Diagrams

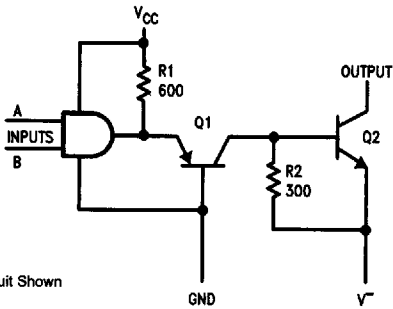

1/2 Circuit Shown

TL/K/10122-1

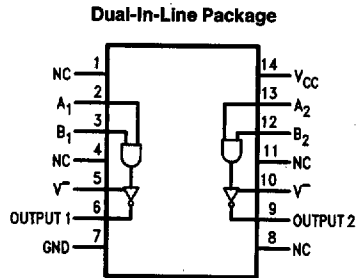

Top View

TL/K/10122-3

Order Number DH0034D-MIL
or DH0034CD
See NS Package Number D14D

Absolute Maximum Ratings

If Military/Aerospace specified devices are required, please contact the National Semiconductor Sales Office/Distributors for availability and specifications.

V _{CC} Supply Voltage	7.0V
Negative Supply Voltage	-30V
Positive Supply Voltage	+25V
Differential Supply Voltage	25V
Maximum Output Current	100 mA
Power Dissipation	(Note 4)

Input Voltage	+ 5.5V
Operating Temperature Range	-55°C to +125°C
DH0034D-MIL	0°C to +85°C
DH0034CD	-65°C to 150°C
Storage Temperature Range	-65°C to 150°C
Lead Temperature (Soldering, 10 sec.)	300°C

Electrical Characteristics (See Notes 1 and 2)

Parameter	Conditions	DH0034			Units
		Min	Typ	Max	
Logical "1" Input Voltage	V _{CC} = 4.5V V _{CC} = 4.75V	2.0			V
Logical "0" Input Voltage	V _{CC} = 5.5V V _{CC} = 5.25V			0.8	V
Logical "1" Input Current	V _{CC} = 5.5V, V _{IN} = 2.4V V _{CC} = 5.25V, V _{IN} = 2.4V			40	μA
Logical "1" Input Current	V _{CC} = 5.5V, V _{IN} = 5.5V V _{CC} = 5.25V, V _{IN} = 5.5V			1.0	mA
Logical "0" Input Current	V _{CC} = 5.5V, V _{IN} = 0.4V V _{CC} = 5.25V, V _{IN} = 0.4V			-1.6	mA
Power Supply Current Logic "0"	V _{CC} = 5.5V, V _{IN} = 4.5V V _{CC} = 5.25V, V _{IN} = 4.5V (Note 3)		30	38	mA
Power Supply Current Logic "1"	V _{CC} = 5.5V, V _{IN} = 0V V _{CC} = 5.25V, V _{IN} = 0V (Note 3)		37	48	mA
Logical "0" Output Voltage	V _{CC} = 4.5V, I _{OUT} = 100 mA V _{CC} = 4.5V, I _{OUT} = 50 mA		V ⁻ + 0.50 V ⁻ + 0.3	V ⁻ + 0.50	V
Output Leakage Current	V _{CC} = 5.5V, V _{IN} = 0.8V V ⁺ - V ⁻ = 25V		0.1	5.0	μA
Transition Time to Logical "0"	V _{CC} = 5.0V, V ₃ = 0V, T _A = 25°C V ⁻ = 25V, R _L = 510Ω		15	25	ns
Transition Time to Logical "1"	V _{CC} = 5.0V, T _A = 25°C V ⁻ = -25V, R _L = 510Ω		35	75	ns

Note 1: The specifications apply over the temperature range -55°C to +125°C for the DH0034D-MIL and over the temperature range -25°C to +85°C for DH0034CD with a 510Ω resistor connected between output and ground, and V⁻ connected to -25V, unless otherwise specified.

Note 2: All typical values are for T_A = 25°C.

Note 3: Current measured is total drawn from V_{CC} supply.

Note 4: Power rating for the Cavity DIP based on a maximum junction temperature of 175°C and θ_{JA} = 180°C/W.

Theory of Operation

When both inputs of the DH0034 are raised to logic "1", the input AND gate is turned "on" allowing Q1's emitter to become forward biased. Q1 provides a level shift and constant output current. The collector current is essentially the same as the emitter which is given by

$$\frac{V_{CC} - V_{BE}}{R1}$$

Approximately 7.0 mA flows out of Q1's collector.

About 2 mA of Q1's collector current is drawn off by pull down resistor, R2. The balance, 5 mA, is available as base drive to Q2 and to charge its associated Miller capacitance. The output is pulled to within a V_{SAT} of V^- . When either (or both) input to the DH0034 is lowered to logic "0", the AND gate output drops to 0.2V turning Q1 off. Deprived of base drive Q2 rapidly turns off causing the output to rise to the V_3 supply voltage. Since Q2's emitter operates between 0.6V and 0.2V, the speed of the DH0034 is greatly enhanced.

Applications Information

1. Paralleling the Outputs

The outputs of the DH0034 may be paralleled to increase output drive capability or to accomplish the "wire OR". In order to prevent current hogging by one output transistor or the other, resistors of $2\Omega/100$ mA value should be inserted between the emitters of the output transistors and the minus supply.

2. Recommended Output Voltage Swing

The graph shows boundary conditions which govern proper operation of the DH0034. **The range of operation for the negative supply is shown on the X axis and must be between -3V and -25V.** The allowable range for the positive supply is governed by the value chosen for V^- . V^+ may be selected by drawing a vertical line through the selected value for V^- and terminated by the boundaries of the operating region. For example, a value of V^- equal to -6V would dictate values of V^+ between -5V and +19V. In general, it is desirable to maintain at least 5V difference between the supplies.

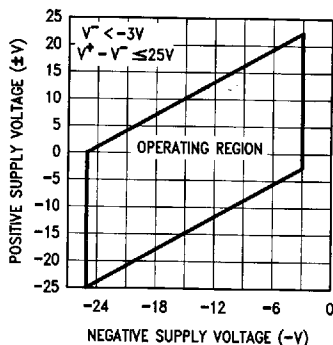

TL/K/10122-6

Switching Time Waveforms

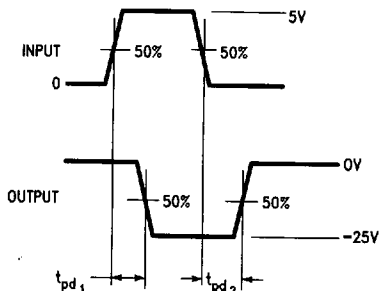

TL/K/10122-7

Typical Applications

5 MHz Analog Switch

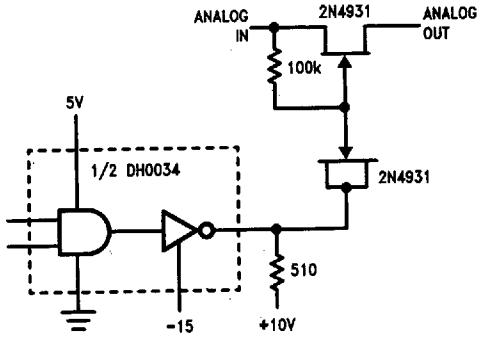

TL/K/10122-4

TTL to IBM (SLT) Logic Levels

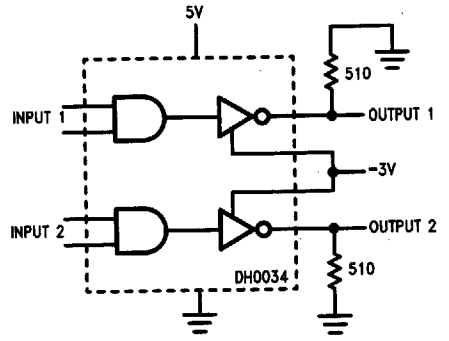

TL/K/10122-5