



P-DUKE POWER

FED60W Series

DC-DC Converter
Up to 60 Watts

3

YEARS
WARRANTY

ROHS
COMPLIANT

REACH
COMPLIANT

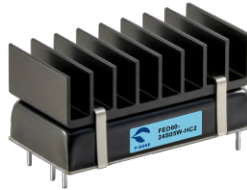

Automation



Datacom



IPC



Industry



Measurement



Telecom



Automobile



Boat



Charger



Medical



PV



Railway



1600
VDC
Isolation
Voltage

4 : 1
Wide
Input
Range

6
sided
Shielding

LOW
Standby
Power

NO
Min. Load
Required

REMOTE
ON
OFF

OCP

OTP

OVP

SCP

UVP

PART NUMBER STRUCTURE

FED60 - 48 S 05 W - M3 N HC

Series Name	Input Voltage (VDC)	Output Quantity	Output Voltage (VDC)	Input Range	Operating Temp. Options	Remote Control Options	Assembly Options
	24:9~36 48:18~75	S:Single D: Dual	3P3:3.3 05:5 12:12 15:15 24:24 12:±12 15:±15 24:±24	4:1	□: Standard -40~+105°C With derating M3: M3 Version -55~+105°C With derating	□: Positive logic N: Negative logic	□: None HC: 7G-0020C-F; H=0.22" (※NRND) HC1: 7GA0120P01-F; H=0.3" HC2: 7GA0121P01-F; H=0.5" HC3: 7GA0122P01-F; H=0.8"

※NRND: Not recommended for new designs

TECHNICAL SPECIFICATION All specifications are typical at nominal input, full load and 25°C unless otherwise noted

Model Number	Input Range	Output Voltage	Output Current @ Full Load	Input Current @ No Load	Efficiency	Maximum Capacitor Load
	VDC	VDC	A	mA	%	μF
FED60-24S3P3W	9 ~ 36	3.3	12	10	90	32000
FED60-24S05W	9 ~ 36	5	12	10	92	30000
FED60-24S12W	9 ~ 36	12	5	10	92	5850
FED60-24S15W	9 ~ 36	15	4	10	92	3900
FED60-24S24W	9 ~ 36	24	2.5	10	92	2000
FED60-24D12W	9 ~ 36	±12	±2.5	10	91	±3900
FED60-24D15W	9 ~ 36	±15	±2	10	91	±2400
FED60-24D24W	9 ~ 36	±24	±1.25	10	91	±1000
FED60-48S3P3W	18 ~ 75	3.3	12	10	90	32000
FED60-48S05W	18 ~ 75	5	12	10	92	30000
FED60-48S12W	18 ~ 75	12	5	10	92	5850
FED60-48S15W	18 ~ 75	15	4	10	92	3900
FED60-48S24W	18 ~ 75	24	2.5	10	91	2000
FED60-48D12W	18 ~ 75	±12	±2.5	10	91	±3900
FED60-48D15W	18 ~ 75	±15	±2	10	91	±2400
FED60-48D24W	18 ~ 75	±24	±1.25	10	91	±1000

INPUT SPECIFICATIONS

Parameter	Conditions	Min.	Typ.	Max.	Unit
Operating input voltage range	24Vin(nom)	9	24	36	VDC
	48Vin(nom)	18	48	75	
Start up voltage	24Vin(nom)			9	VDC
	48Vin(nom)			18	
Shutdown voltage	24Vin(nom)	7	8	8.8	VDC
	48Vin(nom)	15	16	17.5	
Start up time	Constant resistive load	Power up	60		ms
		Remote ON/OFF	60		
Input surge voltage	1 second, max.			50 100	VDC
Input filter				Pi type	
Remote ON/OFF	Referred to -Vin pin	Positive logic	DC-DC ON	Open or 3 ~ 12VDC	
		(Standard)	DC-DC OFF	Short or 0 ~ 1.2VDC	
		Negative logic	DC-DC ON	Short or 0 ~ 1.2VDC	
		(Option)	DC-DC OFF	Open or 3 ~ 12VDC	
		Input current of Ctrl pin		-0.5	
Remote off input current			3		mA

OUTPUT SPECIFICATIONS						
Parameter	Conditions		Min.	Typ.	Max.	Unit
Voltage accuracy			-1.0		+1.0	%
Line regulation	Low Line to High Line at Full Load		-0.2		+0.2	%
Load regulation	No Load to Full Load	Single	-0.5		+0.5	%
		Dual	-1.0		+1.0	
Cross regulation	Asymmetrical load 25%/100% FL	Dual	-5.0		+5.0	%
Voltage adjustability	Single output	3.3Vout, 5Vout, 12Vout	-10		+10	%
		15Vout, 24Vout	-10		+20	
Ripple and noise	Measured by 20MHz bandwidth With a 10µF/25V X7R MLCC With a 10µF/25V X7R MLCC With a 4.7µF/50V X7R MLCC	3.3Vout, 5Vout		75	100	mVp-p
		12Vout, 15Vout		100	125	
		24Vout		150	200	
Temperature coefficient			-0.02		+0.02	%/°C
Transient response recovery time	25% load step change			250		µs
Over voltage protection	Zener diode clamp	3.3Vout		3.9		VDC
		5Vout		6.2		
		12Vout		15		
		15Vout		20		
		24Vout		30		
Over load protection	% of Iout rated; Hiccup mode			150		%
Short circuit protection			Continuous, automatic recovery			

GENERAL SPECIFICATIONS						
Parameter	Conditions		Min.	Typ.	Max.	Unit
Isolation voltage	1 minute	Input to Output	1600			VDC
		Input (Output) to Case	1600			
Isolation resistance	500VDC		1			GΩ
Isolation capacitance					2200	pF
Switching frequency			225	250	275	kHz
Safety approvals	IEC/ EN/ UL62368-1				UL:E193009 CB:UL(Demko)	
Case material			Copper			
Base material			FR4 PCB			
Potting material			Silicone (UL94 V-0)			
Weight			33g (1.16oz)			
MTBF	MIL-HDBK-217F, Full load.		8.582 x 10 ⁵ hrs			

ENVIRONMENTAL SPECIFICATIONS						
Parameter	Conditions		Min.	Typ.	Max.	Unit
Operating ambient temperature	Standard M3 Version	With derating	-40		+105	°C
		With derating	-55		+105	
Maximum case temperature					105	°C
Over temperature protection				115		°C
Storage temperature range			-55		+125	°C
Thermal impedance		Without Heat-sink		10.8		°C/W
		With Heat-sink	HC		10.3	
			HC1		8.3	
			HC2		7.0	
			HC3		5.7	
Thermal shock			MIL-STD-810F			
Vibration			MIL-STD-810F			
Relative humidity			5% to 95% RH			

EMC SPECIFICATIONS

Parameter	Conditions	Level
EMI	EN55032 With external components	Class A, Class B
EMS	EN55035	
ESD	EN61000-4-2 Air \pm 8kV and Contact \pm 6kV	Perf. Criteria A
Radiated immunity	EN61000-4-3 20 V/m	Perf. Criteria A
Fast transient	EN61000-4-4 \pm 2kV	Perf. Criteria A
	FED60-24□□□W With an aluminum electrolytic capacitor (Nippon chemi-con KY series, 220 μ F/100V) and a TVS (SMDJ58A, 58V, 3000Watt peak pulse power) in parallel.	
	FED60-48□□□W With an aluminum electrolytic capacitor (Nippon chemi-con KY series, 220 μ F/100V) and a TVS (SMDJ120A, 120V, 3000Watt peak pulse power) in parallel.	
Surge	EN61000-4-5 \pm 2kV	Perf. Criteria A
	FED60-24□□□W With an aluminum electrolytic capacitor (Nippon chemi-con KY series, 220 μ F/100V) and a TVS (SMDJ58A, 58V, 3000Watt peak pulse power) in parallel.	
	FED60-48□□□W With an aluminum electrolytic capacitor (Nippon chemi-con KY series, 220 μ F/100V) and a TVS (SMDJ120A, 120V, 3000Watt peak pulse power) in parallel.	
Conducted immunity	EN61000-4-6 10 Vr.m.s	Perf. Criteria A
Power frequency magnetic field	EN61000-4-8 100A/m continuous; 1000A/m 1 second	Perf. Criteria A

CAUTION: This power module is not internally fused. An input line fuse must always be used.

CHARACTERISTIC CURVE

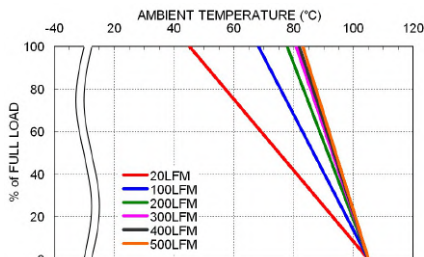

FED60-48S12W Derating Curve

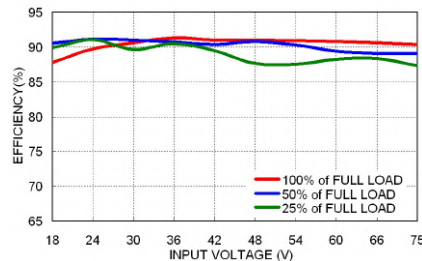

FED60-48S12W Efficiency VS Input Voltage

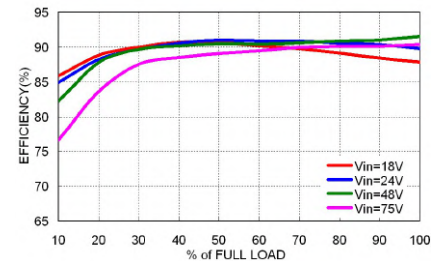

FED60-48S12W Efficiency VS Output Load

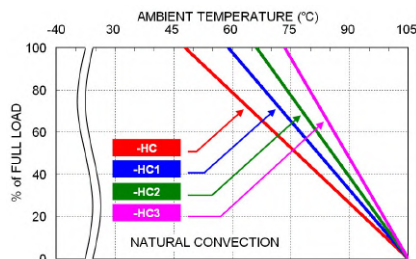

FED60-48S12W Derating Curve With Heat-sink

FUSE CONSIDERATION

This power module is not internally fused. An input line fuse must always be used.

This encapsulated power module can be used in a wide variety of applications, ranging from simple stand-alone operation to an integrated part of sophisticated power architecture.

To maximum flexibility, internal fusing is not included; however, to achieve maximum safety and system protection, always use an input line fuse.

The input line fuse suggest as below :

Model	Fuse Rating (A)	Fuse Type
FED60-24S□□W、FED60-24D□□W	10	Fast-Acting
FED60-48S□□W、FED60-48D□□W	6.3	Slow-Blow

The table based on the information provided in this data sheet on inrush energy and maximum DC input current at low Vin.

MECHANICAL DRAWING

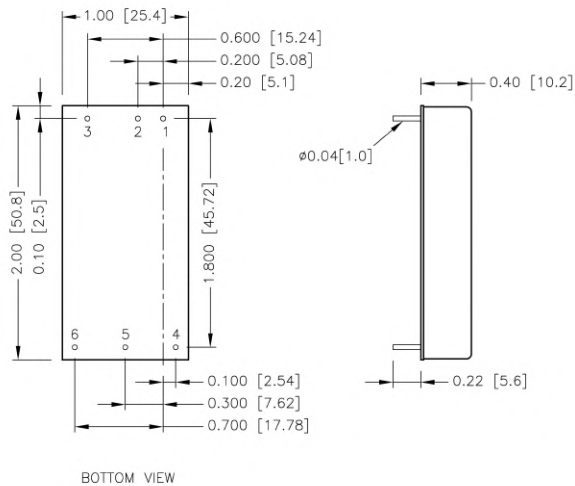

PIN CONNECTION

PIN	SINGLE	DUAL
1	+ Vin	+ Vin
2	- Vin	- Vin
3	Ctrl	Ctrl
4	+ Vout	+ Vout
5	- Vout	Common
6	Trim	- Vout

- All dimensions in inch [mm]
Tolerance :x.xx±0.02 [x.x±0.5]
x.xxx±0.010 [x.xx±0.25]
- Pin dimension tolerance ±0.004 [0.10]

RECOMMENDED PAD LAYOUT

Standard

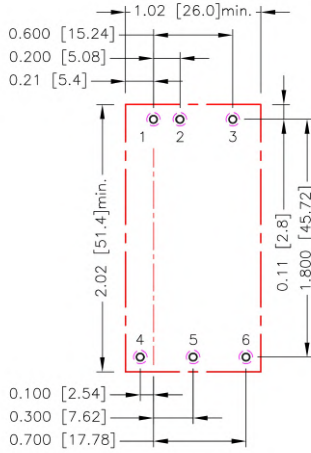

-HC

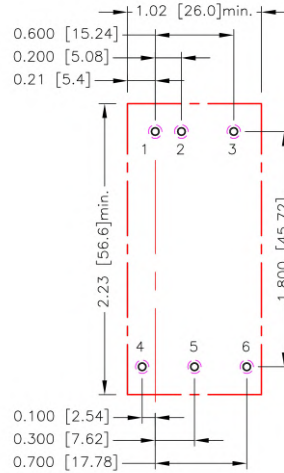

-HC1、-HC2、-HC3

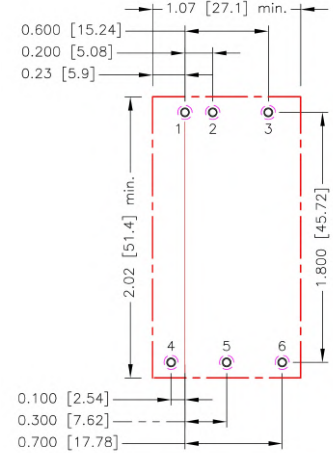

All dimensions in inch[mm]
 Pad size(lead free recommended)
 Through hole 1.2.3.4.5.6: $\Phi 0.051[1.30]$
 Top view pad 1.2.3.4.5.6: $\Phi 0.064[1.63]$
 Bottom view pad 1.2.3.4.5.6: $\Phi 0.102[2.60]$

THERMAL CONSIDERATIONS

The power module operates in a variety of thermal environments. However, sufficient cooling should be provided to help ensure reliable operation of the unit. Heat is removed by conduction, convection, and radiation to the surrounding environment. Proper cooling can be verified by measuring the point as the figure below. The temperature at this location should not exceed "Maximum case temperature". When operating, adequate cooling must be provided to maintain the test point temperature at or below "Maximum case temperature". You can limit this temperature to a lower value for extremely high reliability.

- Thermal test condition with vertical direction by natural convection (20LFM).

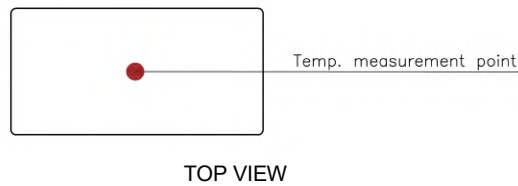

HEAT-SINK TYPE OPTIONS

FED60-□□□□W-**HC**
7G-0020C-F

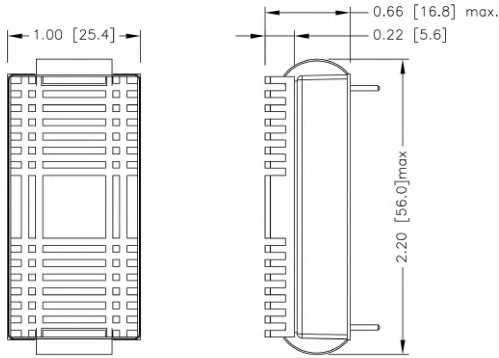

SIDE VIEW

FED60-□□□□W-**HC1**
7GA0120P01-F

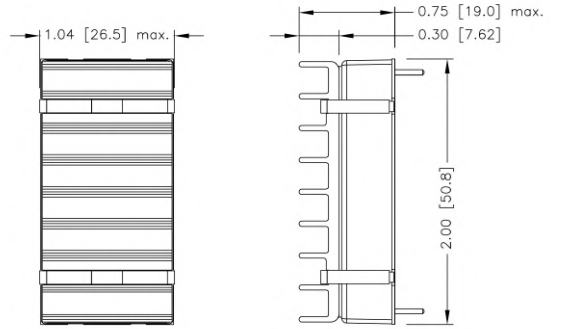

SIDE VIEW

FED60-□□□□W-**HC2**
7GA0121P01-F

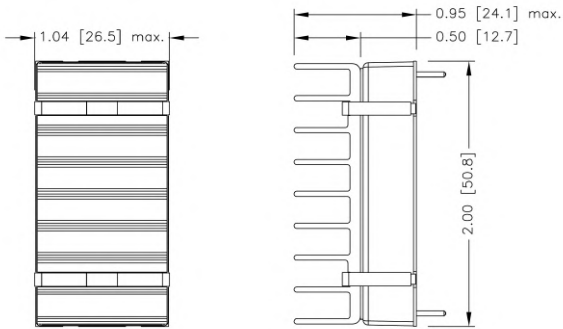

SIDE VIEW

FED60-□□□□W-**HC3**
7GA0122P01-F

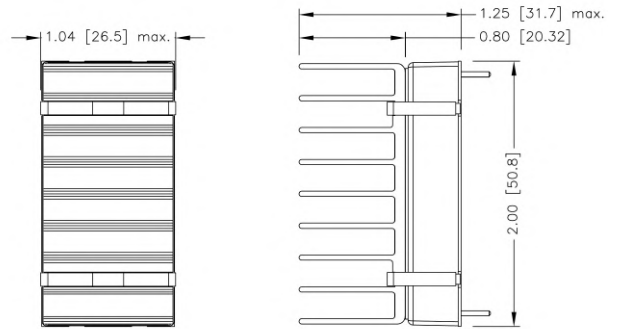

SIDE VIEW

1. All dimensions in inch [mm]
2. Tolerance :x.xx±0.02 [x.x±0.5]
x.xxx±0.010 [x.xx±0.25]

OUTPUT VOLTAGE ADJUSTMENT

Output voltage set point adjustment allows the user to increase or decrease the output voltage set point of the module. This is accomplished by connecting an external resistor between the Trim pin and either the +Output or -Output pins. With an external resistor between the Trim and -Output pin, the output voltage set point increases. With an external resistor between the Trim and +Output pin, the output voltage set point decreases. The external Trim resistor needs to be at least 1/8W of rated power.

EXTERNAL OUTPUT TRIMMING

Output can be externally trimmed by using the method shown below.

Trim-up

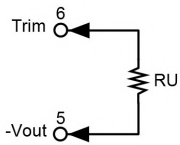

□□S3P3W

ΔV (%)	1	2	3	4	5	6	7	8	9	10
Vout (V)	3.333	3.366	3.399	3.432	3.465	3.498	3.531	3.564	3.597	3.630
RU (k Ω)	57.93	26.165	15.577	10.283	7.106	4.988	3.476	2.341	1.459	0.753

□□S05W

ΔV (%)	1	2	3	4	5	6	7	8	9	10
Vout (V)	5.050	5.100	5.150	5.200	5.250	5.300	5.350	5.400	5.450	5.500
RU (k Ω)	36.57	16.58	9.917	6.585	4.586	3.253	2.302	1.588	1.032	0.588

□□S12W

ΔV (%)	1	2	3	4	5	6	7	8	9	10
Vout (V)	12.120	12.240	12.360	12.480	12.600	12.720	12.840	12.960	13.080	13.200
RU (k Ω)	367.91	165.95	98.636	64.977	44.782	31.318	21.701	14.488	8.879	4.391

□□S15W

ΔV (%)	1	2	3	4	5	6	7	8	9	10
Vout (V)	15.150	15.300	15.450	15.600	15.750	15.900	16.050	16.200	16.350	16.500
RU (k Ω)	419.81	199.91	126.60	89.95	67.96	53.30	42.83	34.98	28.87	23.98
ΔV (%)	11	12	13	14	15	16	17	18	19	20
Vout (V)	16.650	16.800	16.950	17.100	17.250	17.400	17.550	17.700	17.850	18.000
RU (k Ω)	19.98	16.65	13.83	11.42	9.32	7.49	5.87	4.43	3.15	1.99

□□S24W

ΔV (%)	1	2	3	4	5	6	7	8	9	10
Vout (V)	24.240	24.480	24.720	24.960	25.200	25.440	25.680	25.920	26.160	26.400
RU (k Ω)	1275.2	606.60	383.73	272.30	205.44	160.87	129.03	105.15	86.58	71.72
ΔV (%)	11	12	13	14	15	16	17	18	19	20
Vout (V)	26.640	26.880	27.120	27.360	27.600	27.840	28.080	28.320	28.560	28.800
RU (k Ω)	59.56	49.43	40.86	33.51	27.15	21.57	16.66	12.29	8.38	4.86

OUTPUT VOLTAGE ADJUSTMENT(CONTINUED)

Trim-down

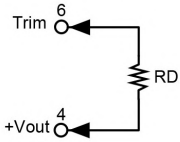
□□S3P3W

ΔV (%)	1	2	3	4	5	6	7	8	9	10
Vout (V)	3.267	3.234	3.201	3.168	3.135	3.102	3.069	3.036	3.003	2.970
RD (k Ω)	69.47	31.235	18.49	12.117	8.294	5.745	3.924	2.559	1.497	0.647

□□S05W

ΔV (%)	1	2	3	4	5	6	7	8	9	10
Vout (V)	4.950	4.900	4.850	4.800	4.750	4.700	4.650	4.600	4.550	4.500
RD (k Ω)	45.533	20.612	12.306	8.152	5.66	3.999	2.812	1.922	1.23	0.676

□□S12W

ΔV (%)	1	2	3	4	5	6	7	8	9	10
Vout (V)	11.880	11.760	11.640	11.520	11.400	11.280	11.160	11.040	10.920	10.800
RD (k Ω)	460.99	207.95	123.6	81.423	56.118	39.249	27.199	18.162	11.132	5.509

□□S15W

ΔV (%)	1	2	3	4	5	6	7	8	9	10
Vout (V)	14.850	14.700	14.550	14.400	14.250	14.100	13.950	13.800	13.650	13.500
RD (k Ω)	284.89	128.68	76.61	50.58	34.96	24.55	17.11	11.53	7.19	3.72

□□S24W

ΔV (%)	1	2	3	4	5	6	7	8	9	10
Vout (V)	23.760	23.520	23.280	23.040	22.800	22.560	22.320	22.080	21.840	21.600
RD (k Ω)	838.15	376.78	222.98	146.09	99.95	69.19	47.22	30.74	17.93	7.68