



2 W High Gain Power Amplifier for Cellular Infrastructure

InGaP GaAs HBT

The MMZ25332B4 is a versatile 2-stage power amplifier targeted at driver and pre-driver applications for macro and micro base stations and final stage applications for small cells. Its versatile design allows operation in any frequency band from 1500 to 2700 MHz providing gain of more than 26.5 dB. The device operates off a 5 V supply, and its bias currents and portions of the matching networks are adjustable for optimum performance in any specific application. It is housed in a QFN 4 x 4 surface mount package which allows for maximum via hole pattern. The MMZ25332B4 offers exceptional reliability, ruggedness and ESD performance.

- Typical Performance: $V_{CC1} = V_{CC2} = V_{BIAS} = 5 \text{ Vdc}$, $I_{CQ} = 400 \text{ mA}$

Frequency	P_{out} (dBm)	G_{ps} (dB)	ACPR (dBc)	I_{CC} (mA)	Test Signal
2140 MHz	21.7	26.5	-48	441	W-CDMA
2350 MHz	21.5	26.6	-48	446	LTE
2600 MHz	22.5	26.7	-48	453	LTE

MMZ25332B4T1

**1500–2700 MHz, 26.5 dB, 33 dBm
 InGaP HBT LINEAR AMPLIFIER**

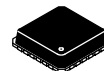

QFN 4 x 4

Features

- Frequency: 1500–2700 MHz
- P1dB: 33 dBm @ 2500 MHz
- Power Gain: 26.5 dB @ 2500 MHz
- OIP3: 48 dBm @ 2500 MHz
- $EVM \leq 3\%$ @ 23.5 dBm P_{out} , WLAN (802.11g)
- Active Bias Control (adjustable externally)
- Power Down Control via V_{BIAS}
- Single 3 to 5 Volt Supply
- Single-ended Power Detector
- Cost-effective 24-Pin, 4 mm QFN Surface Mount Plastic Package

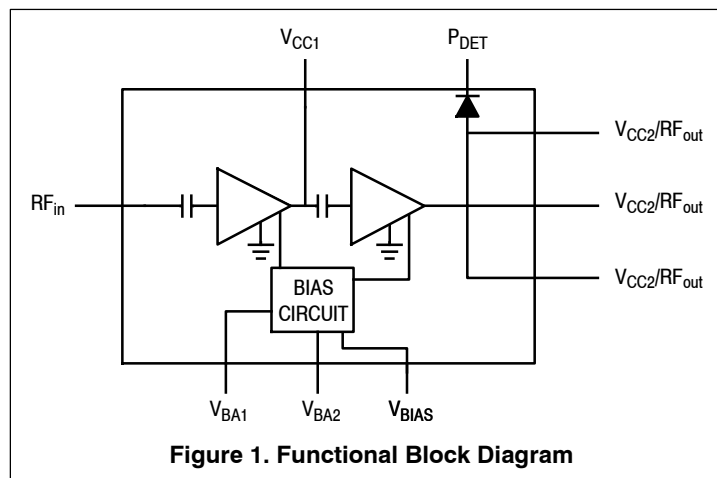

Figure 1. Functional Block Diagram

Table 1. Maximum Ratings

Rating	Symbol	Value	Unit
Supply Voltage	V_{CC}	6	V
Supply Current	I_{CC}	1200	mA
RF Input Power	P_{in}	30	dBm
Storage Temperature Range	T_{stg}	-65 to +150	°C
Junction Temperature	T_J	175	°C

Table 2. Thermal Characteristics

Characteristic	Symbol	Value (1)	Unit
Thermal Resistance, Junction to Case Case Temperature 95°C, $V_{CC1} = V_{CC2} = V_{BIAS} = 5$ Vdc	$R_{\theta JC}$	70 22	°C/W
	Stage 1		
	Stage 2		

Table 3. Electrical Characteristics ($V_{CC1} = V_{CC2} = V_{BIAS} = 5$ Vdc, 2600 MHz, $T_A = 25^\circ\text{C}$, 50 ohm system, in Freescale CW Application Circuit)

Characteristic	Symbol	Min	Typ	Max	Unit
Small-Signal Gain (S21)	G_p	23.5	26	—	dB
Input Return Loss (S11)	IRL	—	-13	—	dB
Output Return Loss (S22)	ORL	—	-18	—	dB
Power Output @ 1dB Compression	P1dB	—	33	—	dBm
Intercept Point, Two-Tone CW	OIP3	—	48	—	dBm
Supply Current	I_{CQ}	368	392	415	mA
Supply Voltage	V_{CC}	—	5	—	V

Table 4. ESD Protection Characteristics

Test Methodology	Class
Human Body Model (per JESD22-A114)	2
Machine Model (per EIA/JESD22-A115)	B
Charge Device Model (per JESD22-C101)	IV

Table 5. Moisture Sensitivity Level

Test Methodology	Rating	Package Peak Temperature	Unit
Per JESD22-A113, IPC/JEDEC J-STD-020	1	260	°C

Table 6. Ordering Information

Device	Tape and Reel Information	Package
MMZ25332B4T1	T1 Suffix = 1,000 Units, 12 mm Tape Width, 13-inch Reel	QFN 4 x 4

1. Refer to [AN1955](#), *Thermal Measurement Methodology of RF Power Amplifiers*. Go to <http://www.freescale.com/rf> and search for AN1955.

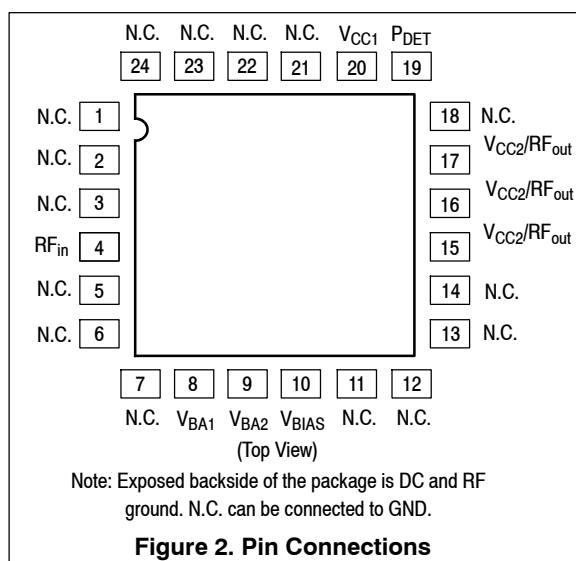

50 OHM APPLICATION CIRCUIT: 2500–2700 MHz, 5 VOLT OPERATION

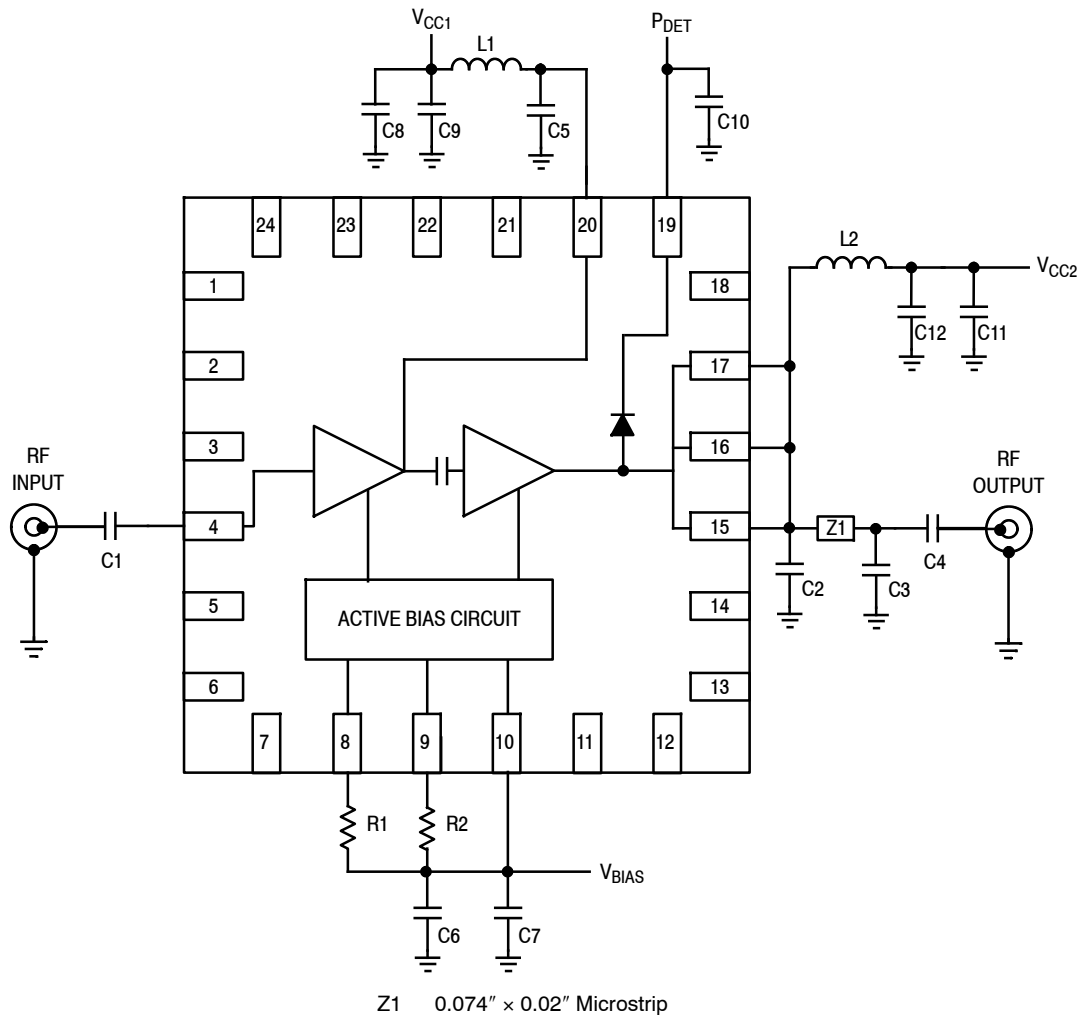
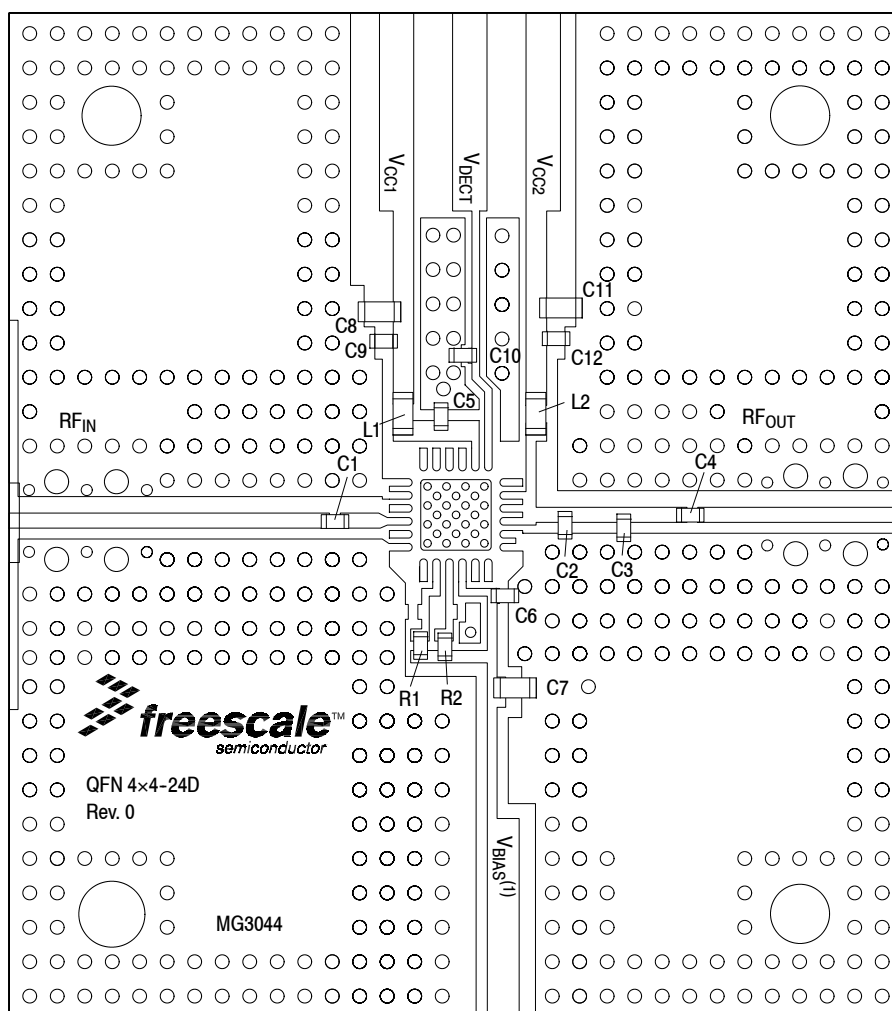

Figure 3. MMZ25332B4T1 Test Circuit Schematic

Table 7. MMZ25332B4T1 Test Circuit Component Designations and Values

Part	Description	Part Number	Manufacturer
C1, C4	22 pF Chip Capacitors	04023J22R0BBS	AVX
C2	2 pF Chip Capacitor	04023J2R0BBS	AVX
C3	1.8 pF Chip Capacitor	04023J1R8BBS	AVX
C5	8.2 pF Chip Capacitor	04023J8R2BBS	AVX
C6, C9, C12	1000 pF Chip Capacitors	GCM155R71E103KA37	Murata
C7, C8	1 uF Chip Capacitors	GRM155R61A105KE15	Murata
C10	470 pF Chip Capacitor	GRM1555C1H471JA01	Murata
C11	4.7 μF Chip Capacitor	GRM188R60J475KE19	Murata
L1	12 nH Chip Inductor	0603HC-12NX	Coilcraft
L2	6.8 nH Chip Inductor	0603HC-6N8X	Coilcraft
R1	1200 Ω, 1/16 W Chip Resistor	RC0402JR-071K2L	Yageo
R2	330 Ω, 1/16 W Chip Resistor	RC0402JR-07330L	Yageo
PCB	Rogers RO4350B, 0.010", ε _r = 3.66	MG3044	MTL

50 OHM APPLICATION CIRCUIT: 2500–2700 MHz, 5 VOLT OPERATION



PCB actual size: 1.30" × 1.46".

(1) V_{BIAS} [Board] supplies V_{BA1} , V_{BA2} and V_{BIAS} [Device].

Figure 4. MMZ25332B4T1 Test Circuit Component Layout

Table 7. MMZ25332B4T1 Test Circuit Component Designations and Values

Part	Description	Part Number	Manufacturer
C1, C4	22 pF Chip Capacitors	04023J22R0BBS	AVX
C2	2 pF Chip Capacitor	04023J2R0BBS	AVX
C3	1.8 pF Chip Capacitor	04023J1R8BBS	AVX
C5	8.2 pF Chip Capacitor	04023J8R2BBS	AVX
C6, C9, C12	1000 pF Chip Capacitors	GCM155R71E103KA37	Murata
C7, C8	1 μ F Chip Capacitors	GRM155R61A105KE15	Murata
C10	470 pF Chip Capacitor	GRM1555C1H471JA01	Murata
C11	4.7 μ F Chip Capacitor	GRM188R60J475KE19	Murata
L1	12 nH Chip Inductor	0603HC-12NX	Coilcraft
L2	6.8 nH Chip Inductor	0603HC-6N8X	Coilcraft
R1	1200 Ω , 1/16 W Chip Resistor	RC0402JR-071K2L	Yageo
R2	330 Ω , 1/16 W Chip Resistor	RC0402JR-07330L	Yageo
PCB	Rogers RO4350B, 0.010", $\epsilon_r = 3.66$	MG3044	MTL

(Test Circuit Component Designations and Values table repeated for reference.)

50 OHM APPLICATION CIRCUIT: 2500–2700 MHz, 5 VOLT OPERATION

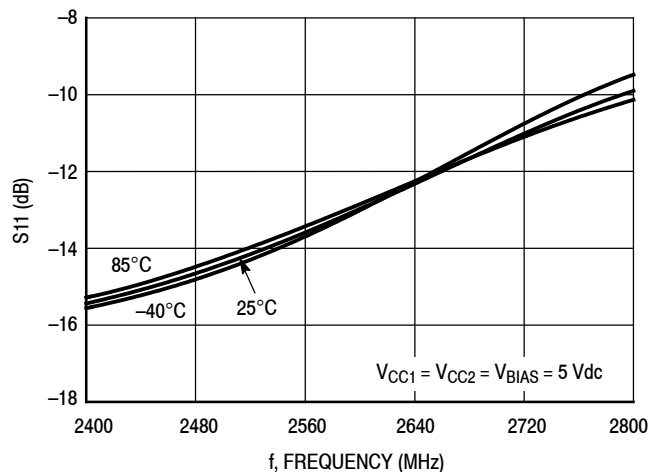

Figure 5. S11 versus Frequency versus Temperature

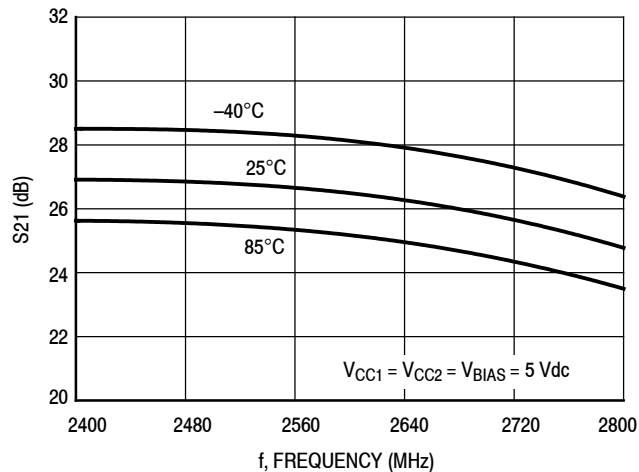

Figure 6. S21 versus Frequency versus Temperature

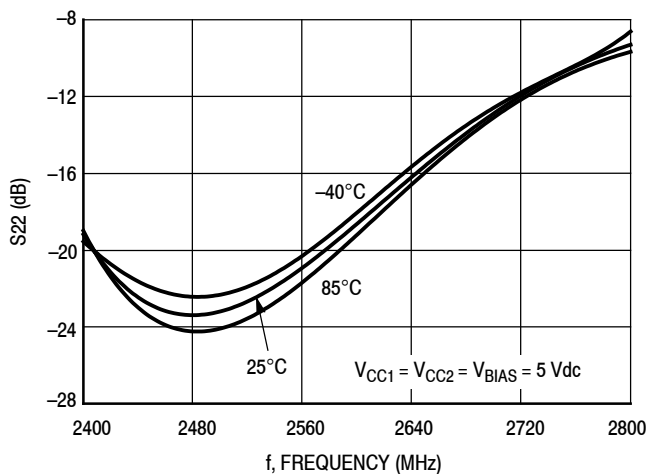

Figure 7. S22 versus Frequency versus Temperature

50 OHM APPLICATION CIRCUIT: 2500–2700 MHz, 5 VOLT OPERATION

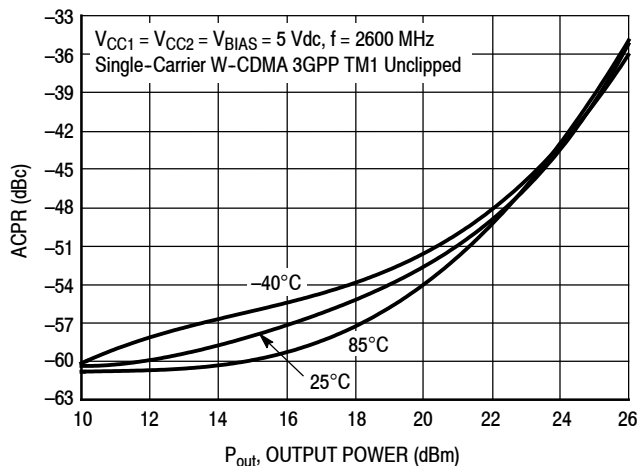

Figure 8. ACPR versus Output Power versus Temperature

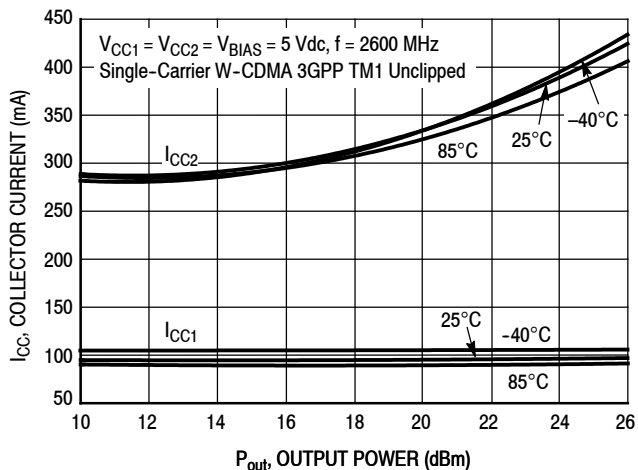

Figure 9. Stage Collector Current versus Output Power versus Temperature

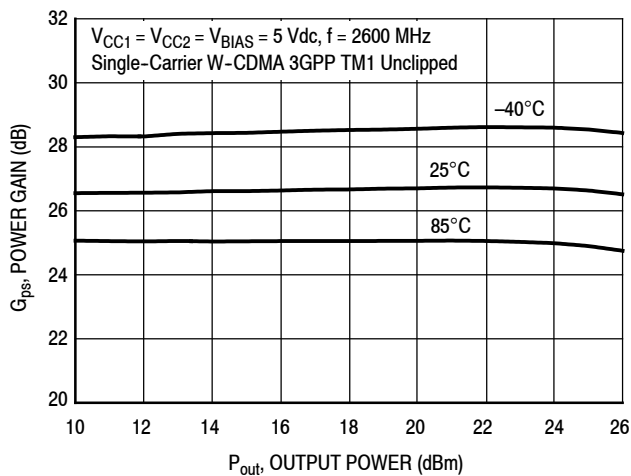

Figure 10. Power Gain versus Output Power versus Temperature

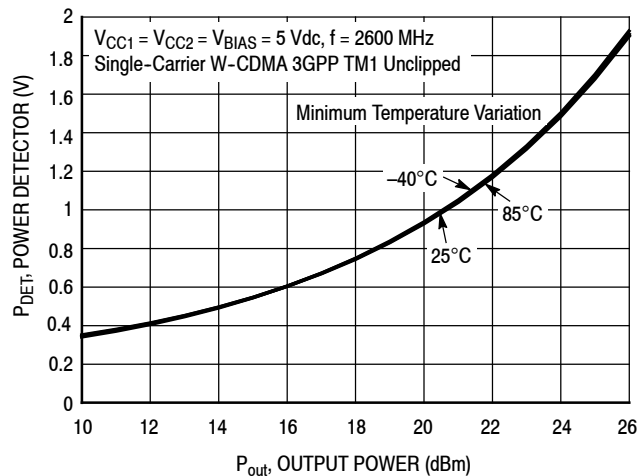

Figure 11. Power Detector versus Output Power versus Temperature

50 OHM APPLICATION CIRCUIT: 2110–2170 MHz, 5 VOLT OPERATION

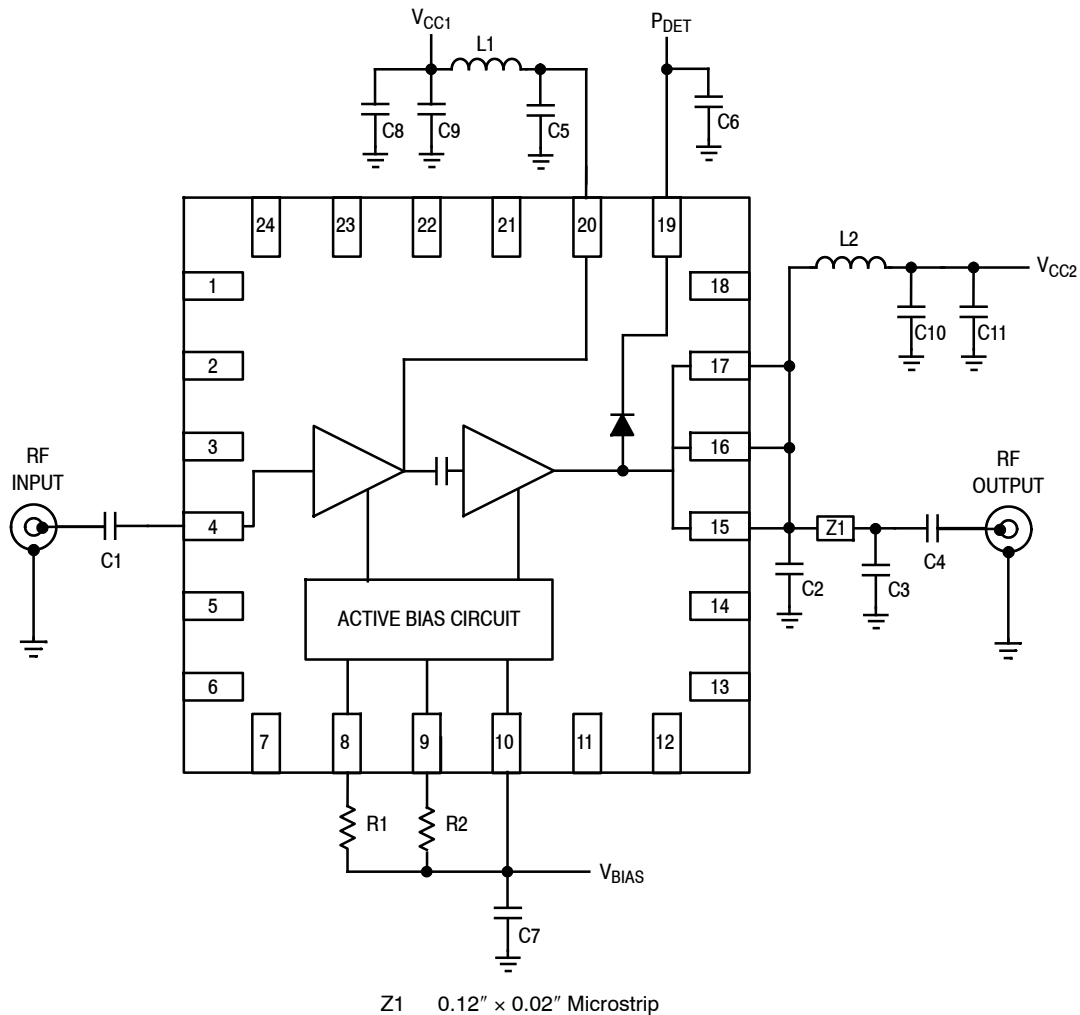
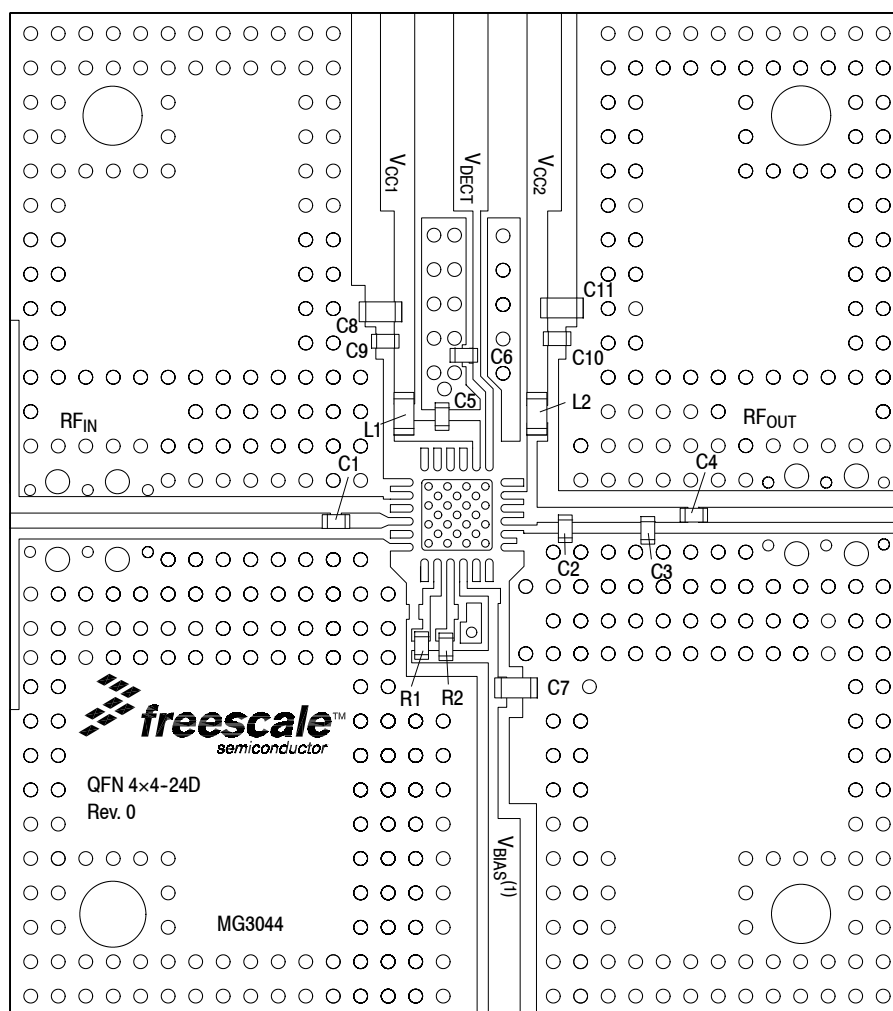

Figure 12. MMZ25332B4T1 Test Circuit Schematic

Table 8. MMZ25332B4T1 Test Circuit Component Designations and Values

Part	Description	Part Number	Manufacturer
C1, C4	22 pF Chip Capacitors	04023J22R0BBS	AVX
C2	2.4 pF Chip Capacitor	04023J2R4BBS	AVX
C3	2.2 pF Chip Capacitor	04023J2R2BBS	AVX
C5	6.8 pF Chip Capacitor	04023J6R8BBS	AVX
C6	470 pF Chip Capacitor	GRM1555C1H471JA01	Murata
C7, C8	1 μF Chip Capacitors	GRM155R61A105KE15	Murata
C9, C10	1000 pF Chip Capacitors	GCM155R71E102KA37	Murata
C11	4.7 μF Chip Capacitor	GRM188R60J475KE19	Murata
L1	12 nH Chip Inductor	0603HC-12NX	Coilcraft
L2	5.6 nH Chip Inductor	LL1608-FSL5N6S	Toko
R1	1.2 kΩ, 1/16 W Chip Resistor	RC0402JR-071K2L	Yageo
R2	330 Ω, 1/16 W Chip Resistor	RC0402JR-07330L	Yageo
PCB	Rogers RO4350B, 0.010", $\epsilon_r = 3.66$	MG3044	MTL

50 OHM APPLICATION CIRCUIT: 2110–2170 MHz, 5 VOLT OPERATION



PCB actual size: 1.30" × 1.46".

(1) V_{BIAS} [Board] supplies V_{BA1} , V_{BA2} and V_{BIAS} [Device].

Figure 13. MMZ25332B4T1 Test Circuit Component Layout

Table 8. MMZ25332B4T1 Test Circuit Component Designations and Values

Part	Description	Part Number	Manufacturer
C1, C4	22 pF Chip Capacitors	04023J22R0BBS	AVX
C2	2.4 pF Chip Capacitor	04023J2R4BBS	AVX
C3	2.2 pF Chip Capacitor	04023J2R2BBS	AVX
C5	6.8 pF Chip Capacitor	04023J6R8BBS	AVX
C6	470 pF Chip Capacitor	GRM1555C1H471JA01	Murata
C7, C8	1 μ F Chip Capacitors	GRM155R61A105KE15	Murata
C9, C10	1000 pF Chip Capacitors	GCM155R71E102KA37	Murata
C11	4.7 μ F Chip Capacitor	GRM188R60J475KE19	Murata
L1	12 nH Chip Inductor	0603HC-12NX	Coilcraft
L2	5.6 nH Chip Inductor	LL1608-FSL5N6S	Toko
R1	1.2 k Ω , 1/16 W Chip Resistor	RC0402JR-071K2L	Yageo
R2	330 Ω , 1/16 W Chip Resistor	RC0402JR-07330L	Yageo
PCB	Rogers RO4350B, 0.010", $\epsilon_r = 3.66$	MG3044	MTL

(Test Circuit Component Designations and Values table repeated for reference.)

50 OHM APPLICATION CIRCUIT: 2110–2170 MHz, 5 VOLT OPERATION

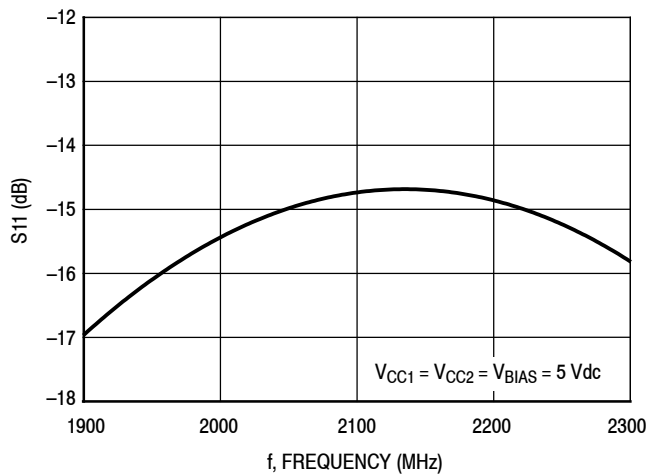

Figure 14. S11 versus Frequency

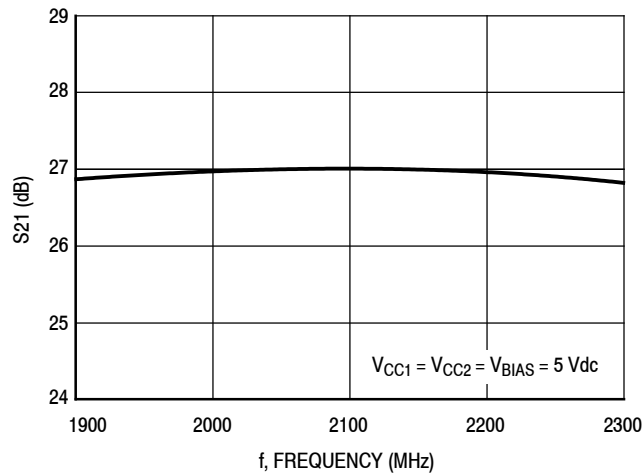

Figure 15. S21 versus Frequency

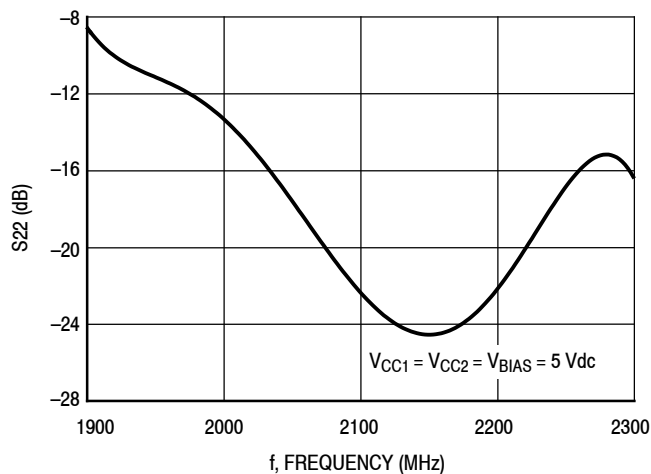

Figure 16. S22 versus Frequency

50 OHM APPLICATION CIRCUIT: 2110–2170 MHz, 5 VOLT OPERATION

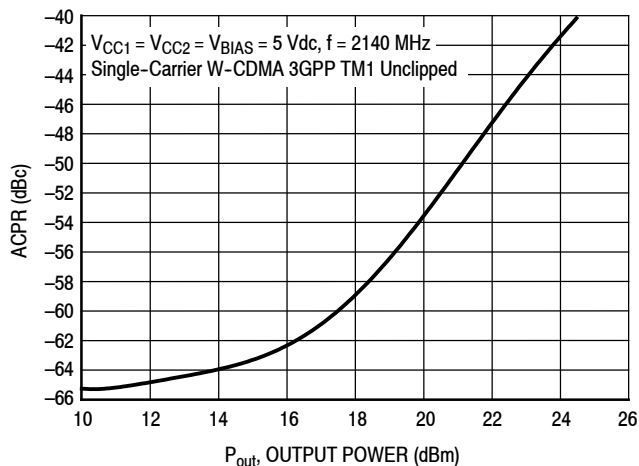

Figure 17. ACPR versus Output Power

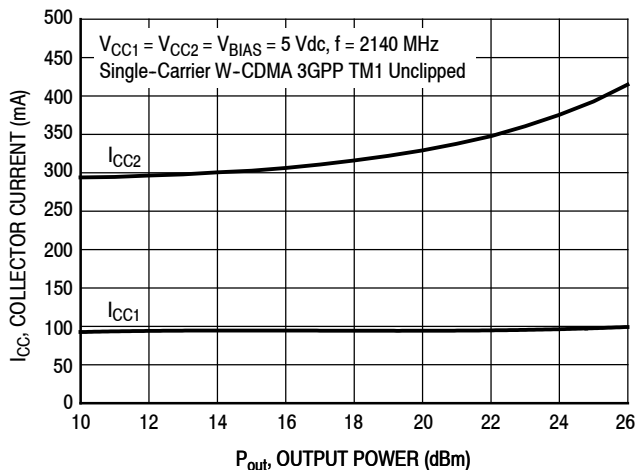

Figure 18. Stage Collector Current versus Output Power

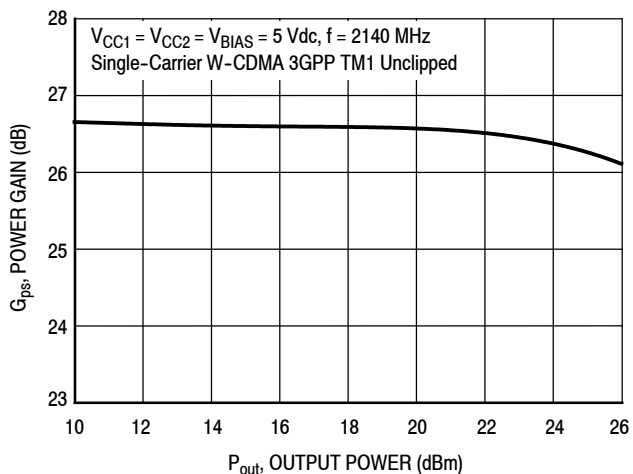

Figure 19. Power Gain versus Output Power

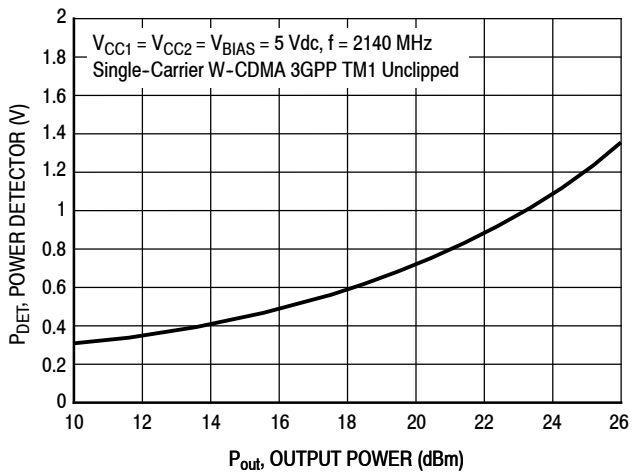

Figure 20. Power Detector versus Output Power

50 OHM APPLICATION CIRCUIT: 2300–2400 MHz, 5 VOLT OPERATION

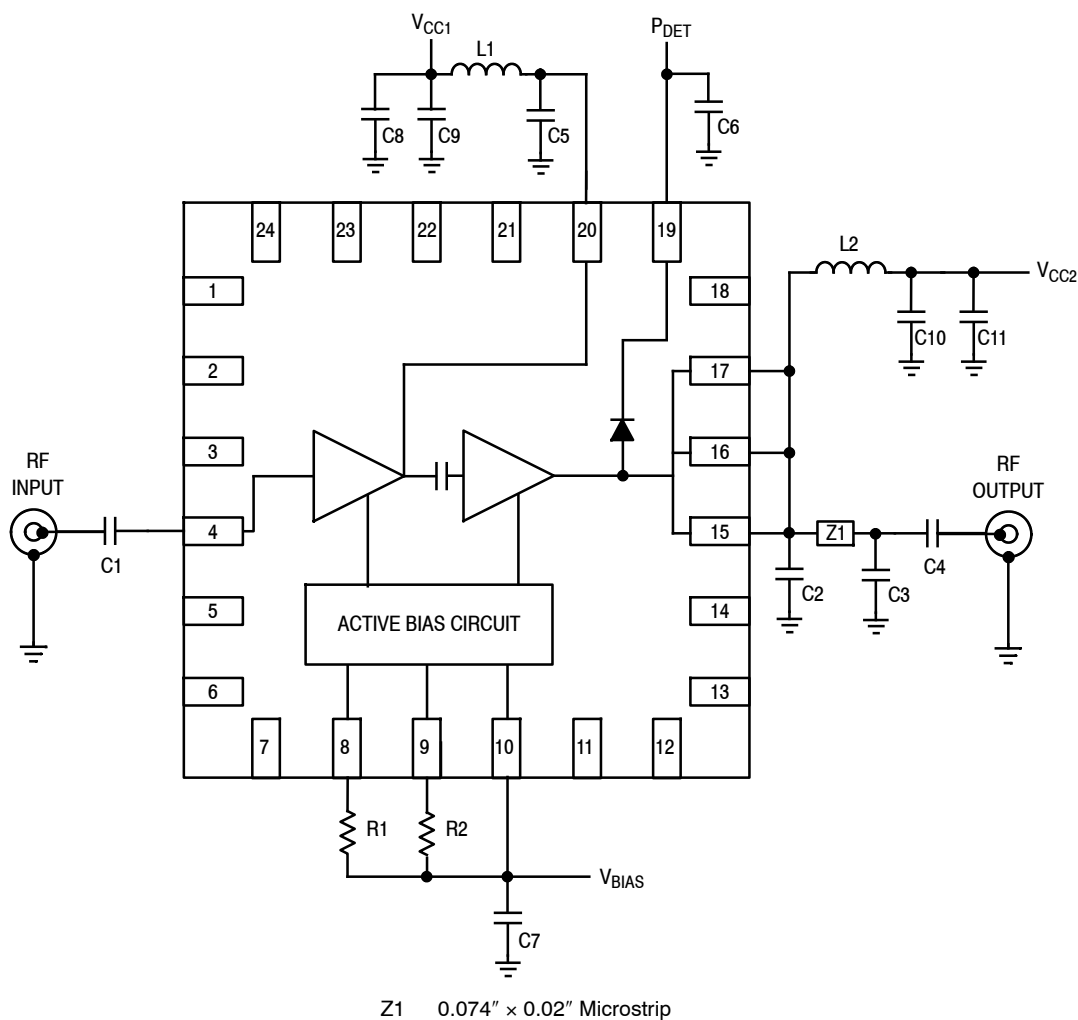
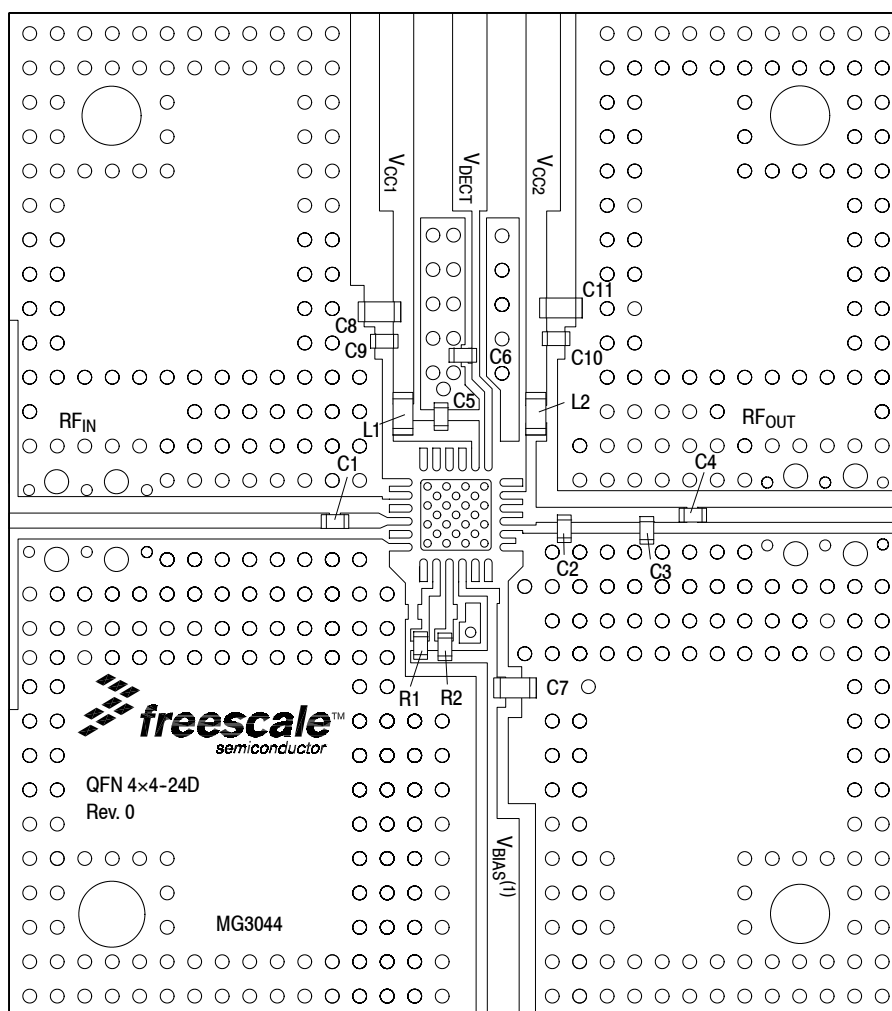

Figure 21. MMZ25332B4T1 Test Circuit Schematic

Table 9. MMZ25332B4T1 Test Circuit Component Designations and Values

Part	Description	Part Number	Manufacturer
C1, C4	22 pF Chip Capacitors	04023J22R0BBS	AVX
C2	2.0 pF Chip Capacitor	04023J2R4BBS	AVX
C3	2.2 pF Chip Capacitor	04023J2R2BBS	AVX
C5	8.2 pF Chip Capacitor	04023J6R8BBS	AVX
C6	470 pF Chip Capacitor	GRM1555C1H471JA01	Murata
C7, C8	1 μF Chip Capacitors	GRM155R61A105KE15	Murata
C9, C10	1000 pF Chip Capacitors	GCM155R71E102KA37	Murata
C11	4.7 μF Chip Capacitor	GRM188R60J475KE19	Murata
L1	12 nH Chip Inductor	0603HC-12NX	Coilcraft
L2	6.8 nH Chip Inductor	LL1608-FSL5N6S	Toko
R1	1.2 kΩ, 1/16 W Chip Resistor	RC0402JR-071K2L	Yageo
R2	330 Ω, 1/16 W Chip Resistor	RC0402JR-07330L	Yageo
PCB	Rogers RO4350B, 0.010", ε _r = 3.66	MG3044	MTL

50 OHM APPLICATION CIRCUIT: 2300–2400 MHz, 5 VOLT OPERATION



PCB actual size: 1.30" × 1.46".

(1) V_{BIAS} [Board] supplies V_{BA1}, V_{BA2} and V_{BIAS} [Device].

Figure 22. MMZ25332B4T1 Test Circuit Component Layout

Table 9. MMZ25332B4T1 Test Circuit Component Designations and Values

Part	Description	Part Number	Manufacturer
C1, C4	22 pF Chip Capacitors	04023J22R0BBS	AVX
C2	2.0 pF Chip Capacitor	04023J2R4BBS	AVX
C3	2.2 pF Chip Capacitor	04023J2R2BBS	AVX
C5	8.2 pF Chip Capacitor	04023J6R8BBS	AVX
C6	470 pF Chip Capacitor	GRM1555C1H471JA01	Murata
C7, C8	1 μF Chip Capacitors	GRM155R61A105KE15	Murata
C9, C10	1000 pF Chip Capacitors	GCM155R71E102KA37	Murata
C11	4.7 μF Chip Capacitor	GRM188R60J475KE19	Murata
L1	12 nH Chip Inductor	0603HC-12NX	Coilcraft
L2	6.8 nH Chip Inductor	LL1608-FSL5N6S	Toko
R1	1.2 kΩ, 1/16 W Chip Resistor	RC0402JR-071K2L	Yageo
R2	330 Ω, 1/16 W Chip Resistor	RC0402JR-07330L	Yageo
PCB	Rogers RO4350B, 0.010", ε _r = 3.66	MG3044	MTL

(Test Circuit Component Designations and Values table repeated for reference.)

50 OHM APPLICATION CIRCUIT: 2300–2400 MHz, 5 VOLT OPERATION

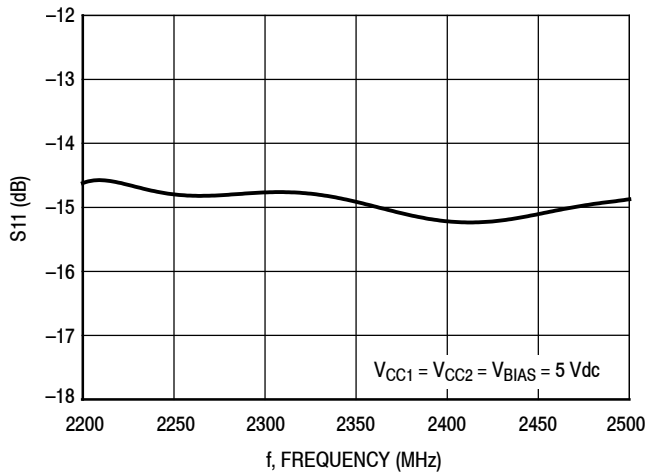

Figure 23. S11 versus Frequency

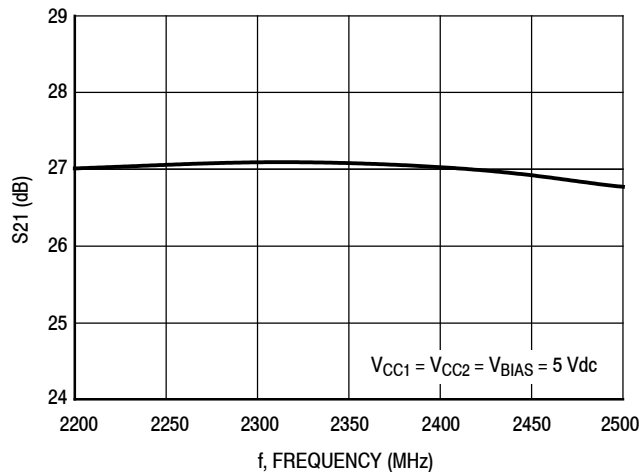

Figure 24. S21 versus Frequency

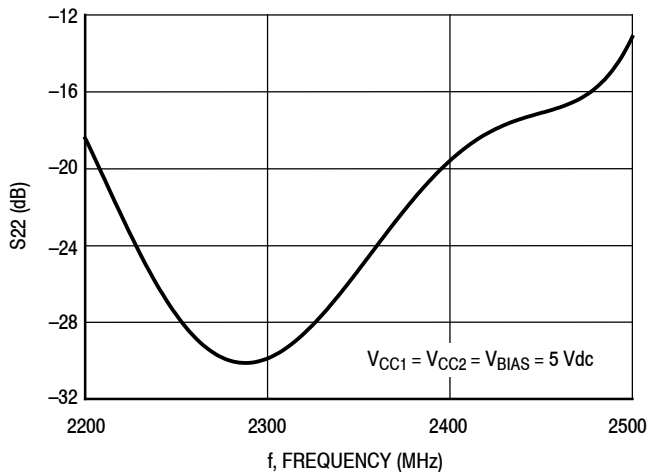

Figure 25. S22 versus Frequency

50 OHM APPLICATION CIRCUIT: 2300–2400 MHz, 5 VOLT OPERATION

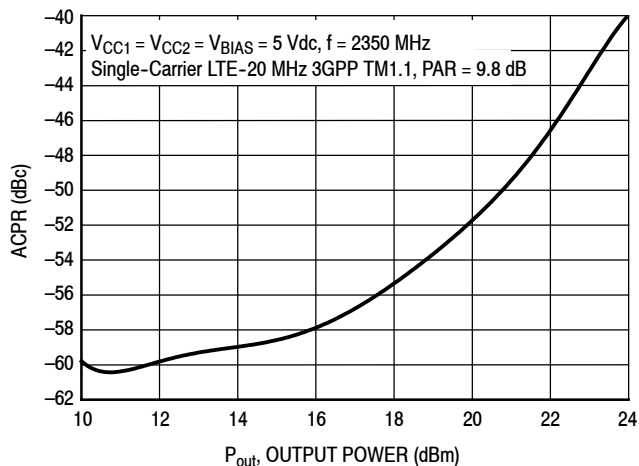

Figure 26. ACPR versus Output Power

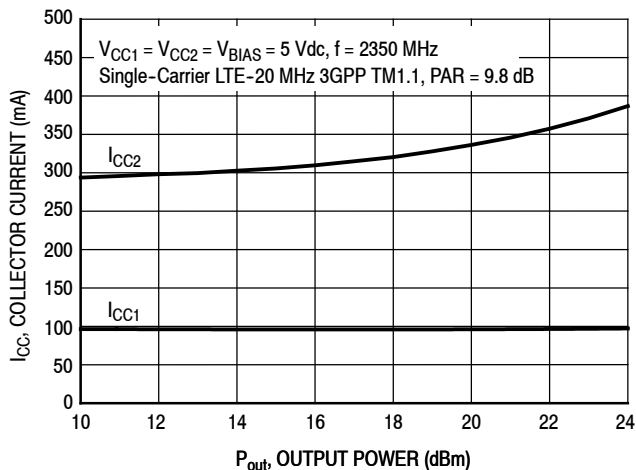

Figure 27. Stage Collector Current versus Output Power

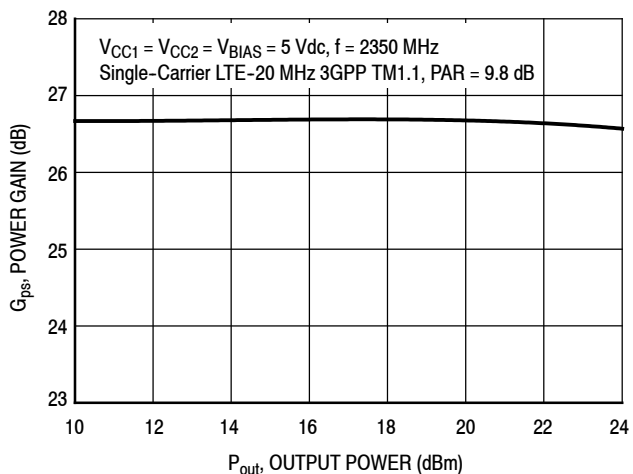

Figure 28. Power Gain versus Output Power

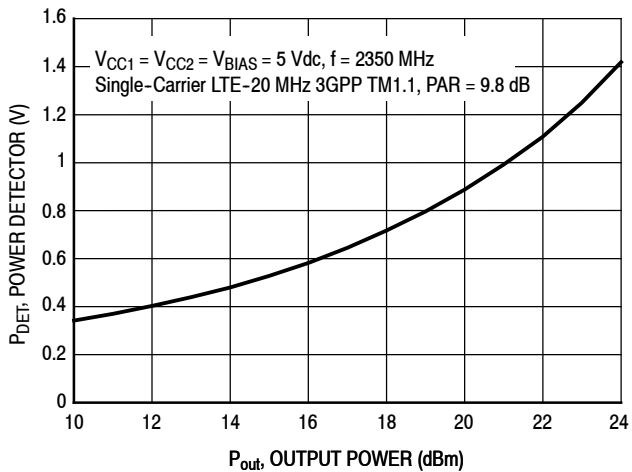

Figure 29. Power Detector versus Output Power

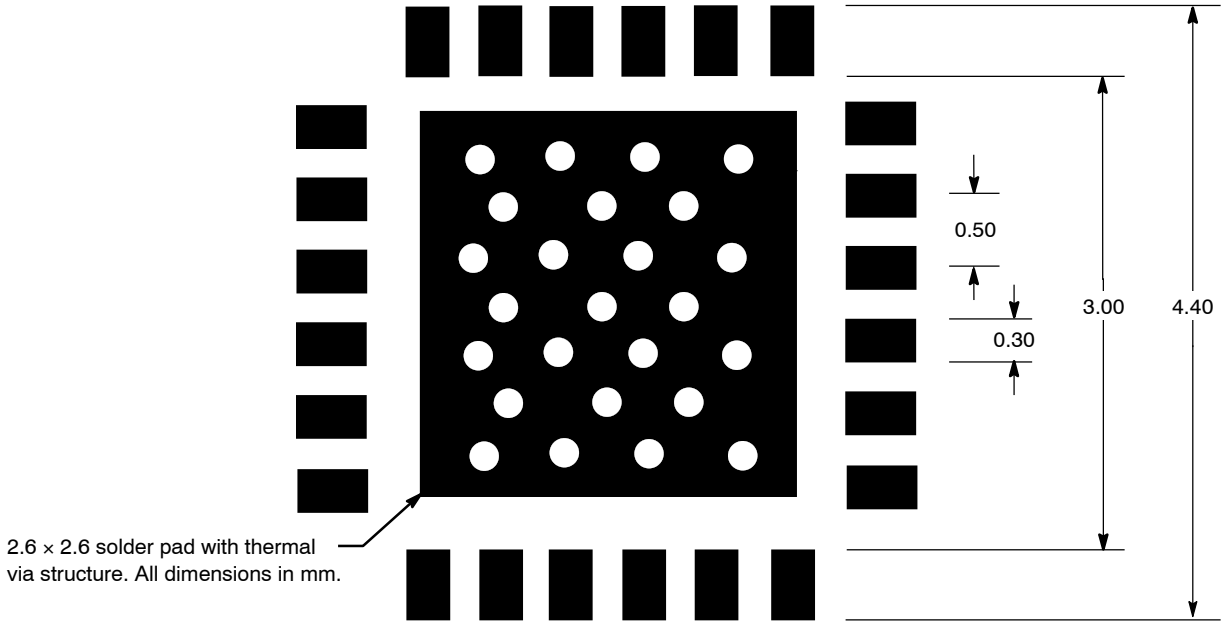

Figure 30. PCB Pad Layout for 24-Lead QFN 4 × 4

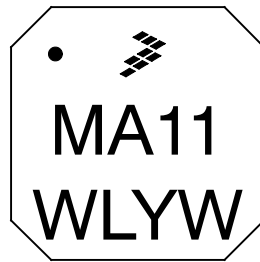
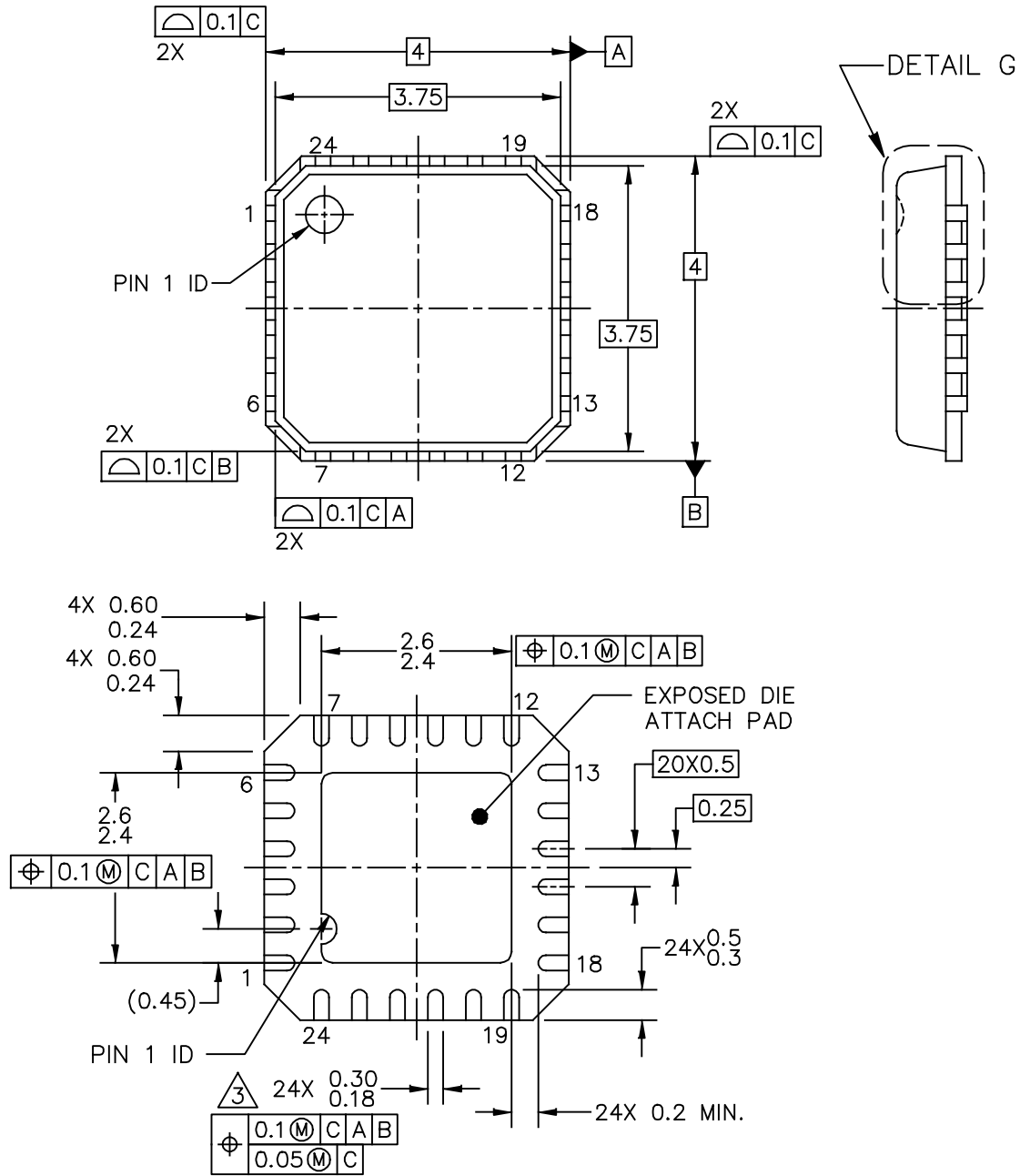
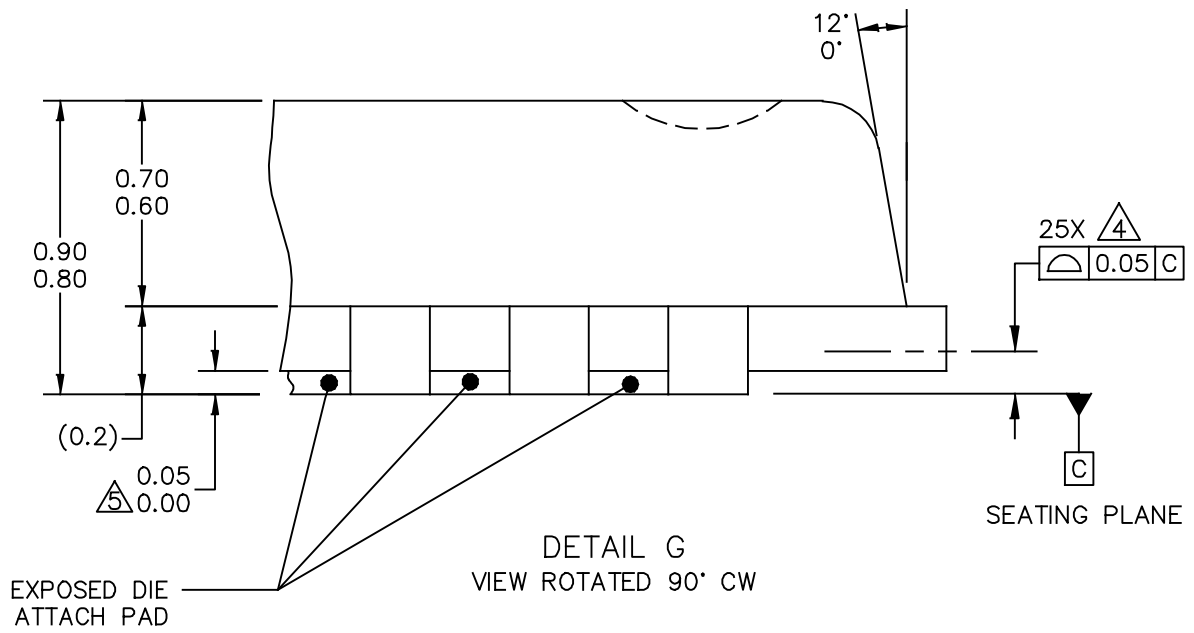

Figure 31. Product Marking

PACKAGE DIMENSIONS



© FREESCALE SEMICONDUCTOR, INC. ALL RIGHTS RESERVED.		MECHANICAL OUTLINE		PRINT VERSION NOT TO SCALE	
TITLE: QFN (PUNCH), THERMALLY ENHANCED 4 X 4 X 0.85, 0.5 PITCH, 24 TERMINAL			DOCUMENT NO: 98ASA00462D		REV: 0
			CASE NUMBER: 2285-01		29 MAR 2012
STANDARD: NON-JEDEC					



© FREESCALE SEMICONDUCTOR, INC. ALL RIGHTS RESERVED.	MECHANICAL OUTLINE	PRINT VERSION NOT TO SCALE	
TITLE: QFN (PUNCH), THERMALLY ENHANCED 4 X 4 X 0.85, 0.5 PITCH, 24 TERMINAL	DOCUMENT NO: 98ASA00462D	REV: 0	
	CASE NUMBER: 2285-01	29 MAR 2012	
	STANDARD: NON-JEDEC		

MMZ25332B4T1

NOTES:

1. ALL DIMENSIONS ARE IN MILLIMETERS.

2. DIMENSIONING AND TOLERANCING PER ASME Y14.5M-1994.

3. THIS DIMENSION APPLIES TO METALIZED TERMINAL AND IS MEASURED BETWEEN 0.15 AND 0.30MM FROM TERMINAL TIP.

4. BILATERAL COPLANARITY ZONE APPLIES TO THE EXPOSED PAD AS WELL AS THE TERMINALS.

5. THIS DIMENSION APPLIES ONLY FOR TERMINALS.

© FREESCALE SEMICONDUCTOR, INC. ALL RIGHTS RESERVED.	MECHANICAL OUTLINE	PRINT VERSION NOT TO SCALE	
TITLE: QFN (PUNCH), THERMALLY ENHANCED 4 X 4 X 0.85, 0.5 PITCH, 24 TERMINAL	DOCUMENT NO: 98ASA00462D	REV: 0	
	CASE NUMBER: 2285-01	29 MAR 2012	
	STANDARD: NON-JEDEC		

PRODUCT DOCUMENTATION, SOFTWARE AND TOOLS

Refer to the following resources to aid your design process.

Application Notes

- AN1955: Thermal Measurement Methodology of RF Power Amplifiers

Software

- .s2p File

Development Tools

- Printed Circuit Boards

To Download Resources Specific to a Given Part Number:

1. Go to <http://www.freescale.com/rf>
2. Search by part number
3. Click part number link
4. Choose the desired resource from the drop down menu

FAILURE ANALYSIS

At this time, because of the physical characteristics of the part, failure analysis is limited to electrical signature analysis. In cases where Freescale is contractually obligated to perform failure analysis (FA) services, full FA may be performed by third party vendors with moderate success. For updates contact your local Freescale Sales Office.

REVISION HISTORY

The following table summarizes revisions to this document.

Revision	Date	Description
0	Dec. 2015	<ul style="list-style-type: none">• Initial Release of Data Sheet

How to Reach Us:

Home Page:
freescale.com

Web Support:
freescale.com/support

Information in this document is provided solely to enable system and software implementers to use Freescale products. There are no express or implied copyright licenses granted hereunder to design or fabricate any integrated circuits based on the information in this document.

Freescale reserves the right to make changes without further notice to any products herein. Freescale makes no warranty, representation, or guarantee regarding the suitability of its products for any particular purpose, nor does Freescale assume any liability arising out of the application or use of any product or circuit, and specifically disclaims any and all liability, including without limitation consequential or incidental damages. "Typical" parameters that may be provided in Freescale data sheets and/or specifications can and do vary in different applications, and actual performance may vary over time. All operating parameters, including "typicals," must be validated for each customer application by customer's technical experts. Freescale does not convey any license under its patent rights nor the rights of others. Freescale sells products pursuant to standard terms and conditions of sale, which can be found at the following address: freescale.com/SalesTermsandConditions.

Freescale and the Freescale logo are trademarks of Freescale Semiconductor, Inc., Reg. U.S. Pat. & Tm. Off. All other product or service names are the property of their respective owners.

© 2015 Freescale Semiconductor, Inc.