

IMPORTANT NOTICE

Dear customer,

As of December 7th, 2015 BL RF Power of NXP Semiconductors will operate as an independent company under the new trade name Ampleon, which will be used in future data sheets together with new contact details.

In data sheets, where the previous Philips references is mentioned, please use the new links as shown below.

<http://www.philips.semiconductors.com> use <http://www.ampleon.com>

<http://www.semiconductors.philips.com> use <http://www.ampleon.com> (Internet)

sales.addresses@www.semiconductors.philips.com use
<http://www.ampleon.com/sales>

The copyright notice at the bottom of each page (or elsewhere in the document, depending on the version)

- © Koninklijke Philips Electronics N.V. (year). All rights reserved -
is replaced with:

- © Ampleon B.V. (year). All rights reserved. -

If you have any questions related to the data sheet, please contact our nearest sales office (details via <http://www.ampleon.com/sales>).

Thank you for your cooperation and understanding,

Ampleon

Microwave power transistor

BLS2731-110

FEATURES

- Suitable for short and medium pulse applications
- Internal input and output matching networks for an easy circuit design
- Emitter ballasting resistors improve ruggedness
- Gold metallization ensures excellent reliability
- Interdigitated emitter-base structure provides high emitter efficiency
- Multicell geometry improves power sharing and reduces thermal resistance.

APPLICATIONS

- Common base class-C pulsed power amplifiers for radar applications in the 2.7 to 3.1 GHz band.

DESCRIPTION

NPN silicon planar epitaxial microwave power transistor in a 2-lead rectangular flange package with a ceramic cap (SOT423A) with the common base connected to the flange.

PINNING - SOT423A

PIN	DESCRIPTION
1	collector
2	emitter
3	base; connected to flange

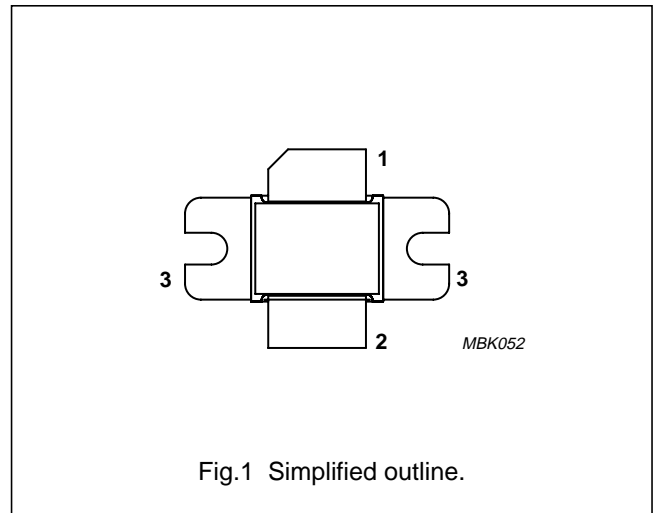

QUICK REFERENCE DATA

RF performance at $T_h = 25\text{ }^\circ\text{C}$ in a common base class-C test circuit.

MODE OF OPERATION	f (GHz)	V _{CB} (V)	P _L (W)	G _p (dB)	η _c (%)
Pulsed class-C	2.7 to 3.1	40	>110	>7	>35

WARNING

Product and environmental safety - toxic materials

This product contains beryllium oxide. The product is entirely safe provided that the BeO disc is not damaged. All persons who handle, use or dispose of this product should be aware of its nature and of the necessary safety precautions. After use, dispose of as chemical or special waste according to the regulations applying at the location of the user. It must never be thrown out with the general or domestic waste.

Microwave power transistor

BLS2731-110

LIMITING VALUES

In accordance with the Absolute Maximum Rating System (IEC 60134).

SYMBOL	PARAMETER	CONDITIONS	MIN.	MAX.	UNIT
V_{CBO}	collector-base voltage	open emitter	–	75	V
V_{CES}	collector-emitter voltage	$R_{BE} = 0$	–	75	V
V_{EBO}	emitter-base voltage	open collector	–	2	V
I_{CM}	peak collector current	$t_p \leq 100 \mu\text{s}$; $\delta \leq 10\%$	–	12	A
P_{tot}	total power dissipation	$t_p = 100 \mu\text{s}$; $\delta = 10\%$; $T_{mb} = 25 \text{ }^\circ\text{C}$	–	500	W
T_{stg}	storage temperature		–65	+200	$^\circ\text{C}$
T_j	operating junction temperature		–	200	$^\circ\text{C}$
T_{sld}	soldering temperature	up to 0.2 mm from ceramic cap; $t \leq 10 \text{ s}$	–	235	$^\circ\text{C}$

THERMAL CHARACTERISTICS

SYMBOL	PARAMETER	CONDITIONS	VALUE	UNIT
$Z_{th\ j-h}$	thermal impedance from junction to heatsink	$t_p = 100 \mu\text{s}$; $\delta = 10\%$; note 1	0.24	K/W

Note

1. Equivalent thermal impedance under pulsed microwave operating conditions.

CHARACTERISTICS $T_j = 25 \text{ }^\circ\text{C}$ unless otherwise specified.

SYMBOL	PARAMETER	CONDITIONS	MIN.	MAX.	UNIT
$V_{(BR)CBO}$	collector-base breakdown voltage	$I_C = 30 \text{ mA}$; open emitter	75	–	V
$V_{(BR)CES}$	collector-emitter breakdown voltage	$I_C = 30 \text{ mA}$; $V_{BE} = 0$	75	–	V
I_{CBO}	collector leakage current	$V_{CB} = 40 \text{ V}$; $I_E = 0$	–	3	mA
I_{CES}	collector leakage current	$V_{CE} = 40 \text{ V}$; $V_{BE} = 0$	–	6	mA
I_{EBO}	emitter leakage current	$V_{EB} = 1.5 \text{ V}$; $I_C = 0$	–	0.6	mA
h_{FE}	DC current gain	$V_{CE} = 5 \text{ V}$; $I_C = 3 \text{ A}$	40	100	

APPLICATION INFORMATIONRF performance at $T_h = 25 \text{ }^\circ\text{C}$ in a common base test circuit.

MODE OF OPERATION	f (GHz)	V_{CE} (V)	P_L (W)	G_p (dB)	η_c (%)
Class-C; $t_p = 100 \mu\text{s}$; $\delta = 10\%$	2.7 to 3.1	40	≥ 110	≥ 7	≥ 35
	2.7 to 2.9	40	typ. 130	typ. 8	typ. 42
	2.9 to 3.1	40	typ. 120	typ. 7.5	typ. 40

Microwave power transistor

BLS2731-110

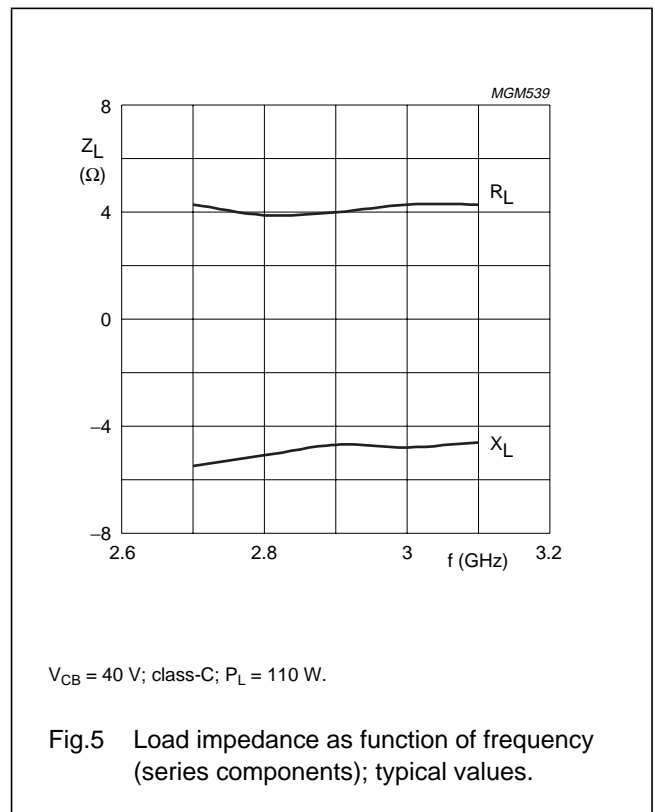
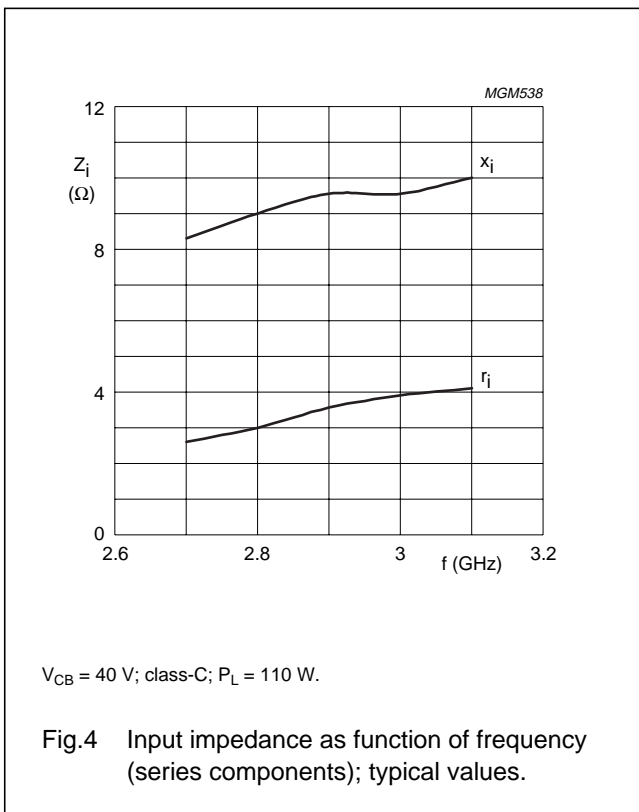
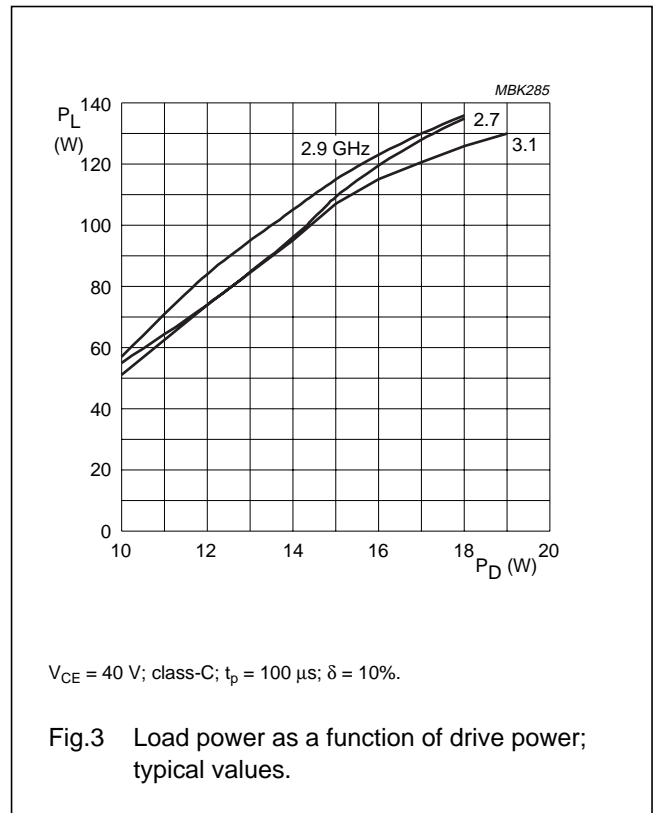
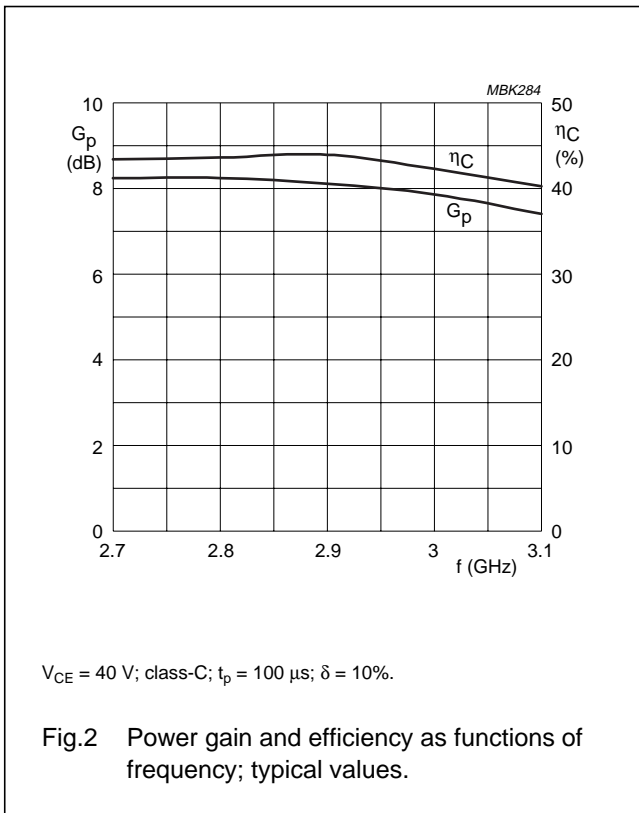

Microwave power transistor

BLS2731-110

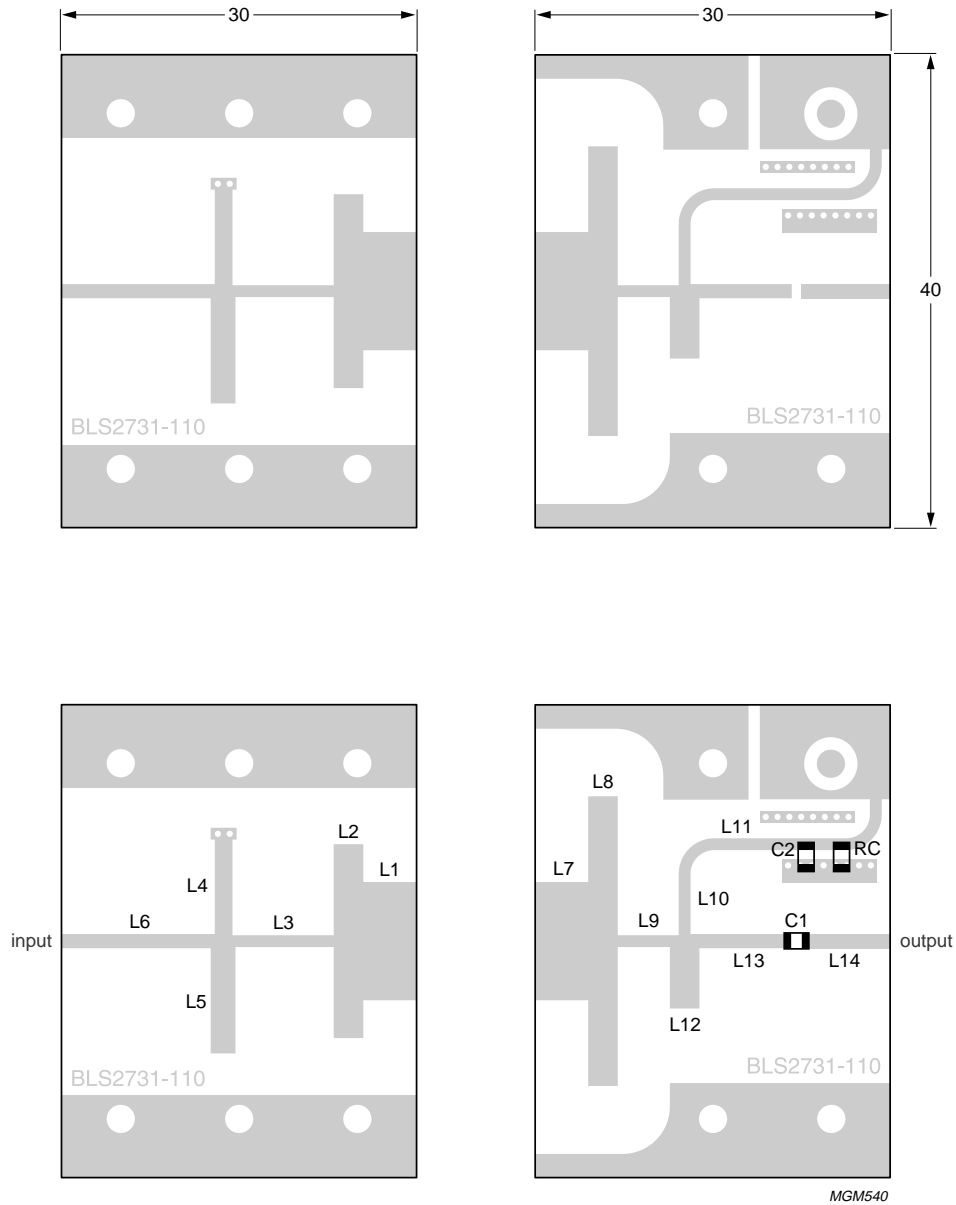

Dimensions in mm.

The components are located on one side of the copper-clad printed-circuit board, the other side is unetched and serves as a ground plane. Earth connections from the component side to the ground plane are made by through metallization.

Fig.6 Component layout for 2.7 to 3.1 GHz class-C test circuit.

Microwave power transistor

BLS2731-110

List of components (see Fig.6)

COMPONENT	DESCRIPTION	VALUE	DIMENSIONS
C1	multilayer ceramic chip capacitor; note 1	12 pF	
C2	multilayer ceramic chip capacitor; note 1	18 pF	
RC	multilayer ceramic chip capacitor in series with SMD resistor	100 nF + 5 Ω	
L1	stripline; note 2		length 4.5 mm width 10 mm
L2	stripline; note 2		length 2.5 mm width 16.4 mm
L3	stripline; note 2		length 8.3 mm width 1 mm
L4	stripline; note 2		length 8 mm width 1.5 mm
L5	stripline; note 2		length 2 mm width 8.9 mm
L6	stripline; note 2		length 12.7 mm width 1.2 mm
L7	stripline; note 2		length 4.5 mm width 10 mm
L8	stripline; note 2		length 2.5 mm width 24.4 mm
L9	stripline; note 2		length 4.4 mm width 1 mm
L10	stripline; note 2		length 5.2 mm width 1 mm
L11	stripline; note 2		length 9.3 mm width 1 mm
L12	stripline; note 2		length 2.5 mm width 6 mm
L13	stripline; note 2		length 7.8 mm width 1.2 mm
L14	stripline; note 2		length 7.5 mm width 1.2 mm

Notes

- American Technical Ceramics type 100A or capacitor of same quality.
- The striplines are on double-clad printed-circuit board with Duroid dielectric ($\epsilon_r = 2.2$); thickness = 0.38 mm.

Microwave power transistor

BLS2731-110

PACKAGE OUTLINE

Flanged hermetic ceramic package; 2 mounting holes; 2 leads

SOT423A

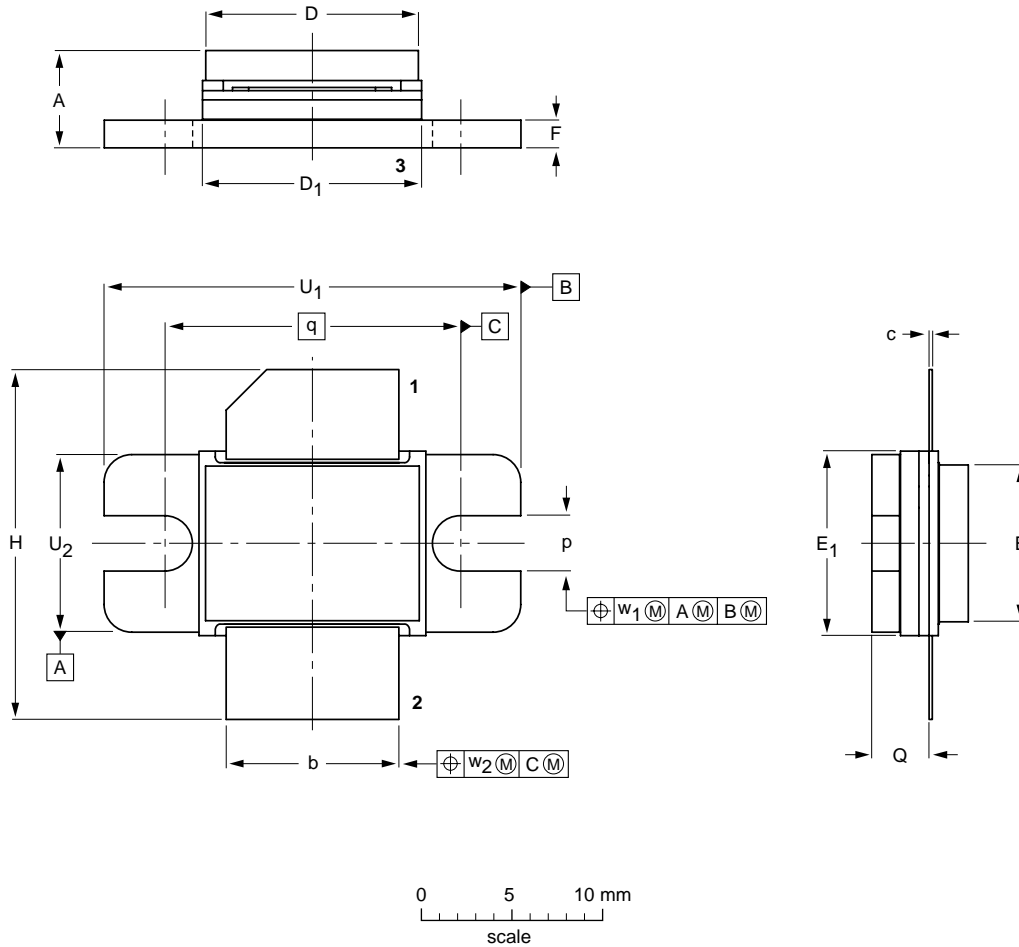

DIMENSIONS (millimetre dimensions are derived from the original inch dimensions)

UNIT	A	b	c	D	D ₁	E	E ₁	F	H	p	Q	q	U ₁	U ₂	w ₁	w ₂
mm	5.72 4.90	9.53 9.27	0.10 0.05	12.09 11.71	12.83 12.57	8.84 8.56	10.29 10.03	1.58 1.47	19.81 18.29	3.43 3.18	3.35 2.95	16.51	22.99 22.73	9.91 9.65	0.25	0.76
inches	0.225 0.193	0.375 0.365	0.004 0.002	0.476 0.461	0.505 0.495	0.348 0.337	0.405 0.395	0.062 0.058	0.78 0.72	0.135 0.125	0.132 0.116	0.65	0.905 0.895	0.390 0.380	0.01	0.03

OUTLINE VERSION	REFERENCES			EUROPEAN PROJECTION	ISSUE DATE
	IEC	JEDEC	EIAJ		
SOT423A					99-03-29

Microwave power transistor

BLS2731-110

DATA SHEET STATUS

DATA SHEET STATUS ⁽¹⁾	PRODUCT STATUS ⁽²⁾	DEFINITIONS
Objective data	Development	This data sheet contains data from the objective specification for product development. Philips Semiconductors reserves the right to change the specification in any manner without notice.
Preliminary data	Qualification	This data sheet contains data from the preliminary specification. Supplementary data will be published at a later date. Philips Semiconductors reserves the right to change the specification without notice, in order to improve the design and supply the best possible product.
Product data	Production	This data sheet contains data from the product specification. Philips Semiconductors reserves the right to make changes at any time in order to improve the design, manufacturing and supply. Changes will be communicated according to the Customer Product/Process Change Notification (CPCN) procedure SNW-SQ-650A.

Notes

1. Please consult the most recently issued data sheet before initiating or completing a design.
2. The product status of the device(s) described in this data sheet may have changed since this data sheet was published. The latest information is available on the Internet at URL <http://www.semiconductors.philips.com>.

DEFINITIONS

Short-form specification — The data in a short-form specification is extracted from a full data sheet with the same type number and title. For detailed information see the relevant data sheet or data handbook.

Limiting values definition — Limiting values given are in accordance with the Absolute Maximum Rating System (IEC 60134). Stress above one or more of the limiting values may cause permanent damage to the device. These are stress ratings only and operation of the device at these or at any other conditions above those given in the Characteristics sections of the specification is not implied. Exposure to limiting values for extended periods may affect device reliability.

Application information — Applications that are described herein for any of these products are for illustrative purposes only. Philips Semiconductors make no representation or warranty that such applications will be suitable for the specified use without further testing or modification.

DISCLAIMERS

Life support applications — These products are not designed for use in life support appliances, devices, or systems where malfunction of these products can reasonably be expected to result in personal injury. Philips Semiconductors customers using or selling these products for use in such applications do so at their own risk and agree to fully indemnify Philips Semiconductors for any damages resulting from such application.

Right to make changes — Philips Semiconductors reserves the right to make changes, without notice, in the products, including circuits, standard cells, and/or software, described or contained herein in order to improve design and/or performance. Philips Semiconductors assumes no responsibility or liability for the use of any of these products, conveys no licence or title under any patent, copyright, or mask work right to these products, and makes no representations or warranties that these products are free from patent, copyright, or mask work right infringement, unless otherwise specified.

CAUTION

This product is supplied in anti-static packing to prevent damage caused by electrostatic discharge during transport and handling. For further information, refer to Philips specs.: SNW-EQ-608, SNW-FQ-302A and SNW-FQ-302B.

Microwave power transistor

BLS2731-110

NOTES

Microwave power transistor

BLS2731-110

NOTES

Microwave power transistor

BLS2731-110

NOTES

Philips Semiconductors – a worldwide company

Contact information

For additional information please visit <http://www.semiconductors.philips.com>. Fax: +31 40 27 24825

For sales offices addresses send e-mail to: sales.addresses@www.semiconductors.philips.com.

© Koninklijke Philips Electronics N.V. 2001

SCA73

All rights are reserved. Reproduction in whole or in part is prohibited without the prior written consent of the copyright owner.

The information presented in this document does not form part of any quotation or contract, is believed to be accurate and reliable and may be changed without notice. No liability will be accepted by the publisher for any consequence of its use. Publication thereof does not convey nor imply any license under patent- or other industrial or intellectual property rights.

Printed in The Netherlands

613524/05/pp12

Date of release: 2001 Dec 05

Document order number: 9397 750 09083

Let's make things better.

**Philips
Semiconductors**



PHILIPS