

#### Features

April 2003

- Broadband 1 to 2000MHz
- Low Power (500mW)
- 3 Diff Outputs
- 6 Single Outputs
- High Linearity
- IIP3 = +20dBm
- IIP2 = +50dBm
- NF = 8dB
- >40dB AGC Range
- Ultra Fast AGC
- Gain Tracking Error <1dB

#### Applications

- RF Signal Switching
- RF Signal Level Control
- Phased Arrays
- Instrumentation
- ATE
- Base Station RX and TX
- Adaptive Antenna's Systems
- Video Recorders
- RF Signal Distribution
- Multiple Tuners
- Satellite, Cable, Terrestrial Digital TV Multiple Tuners

#### Ordering Information

ZL40000/LCE	28 MLP Tubes
ZL40000/LCF	28 MLP Tape & Reel

**-40°C to +80°C**

#### Description

The ZL40000 is an ultra high linearity RF power divider. The device provides a 75 Ohm Input impedance to a broad band RF input Signal. The signal is buffered through an ultra high linearity 6dB Gain buffer. This is followed by a power divider which splits the buffered signal into 3 signals. One signal is passed through a 200Ohm differential output driver. The other two signals are passed through two separate 0 to -40dB AGC stages before output as two isolated independent differential Signals.

The device is built on Zarlink's 20GHz Complimentary Bipolar Process.

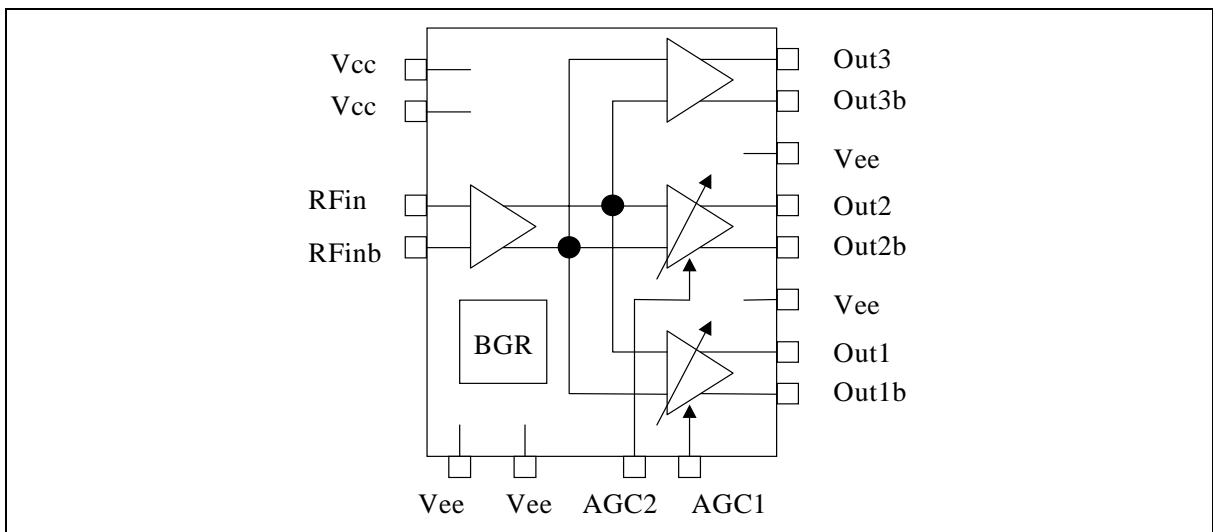

**Figure 1 - Functional Block Diagram**

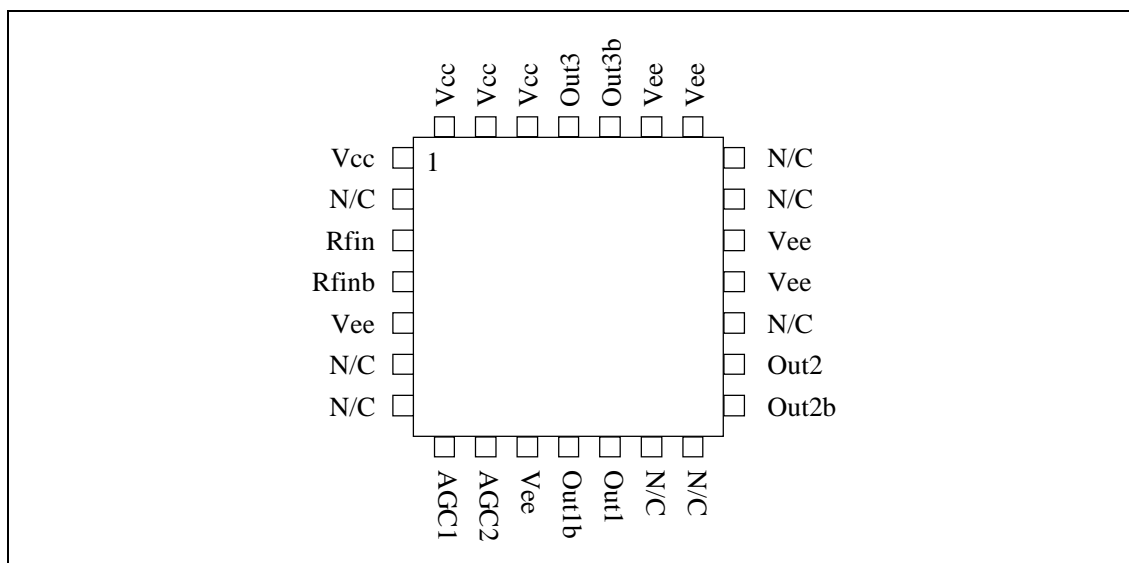

Figure 2 - Pin Diagram

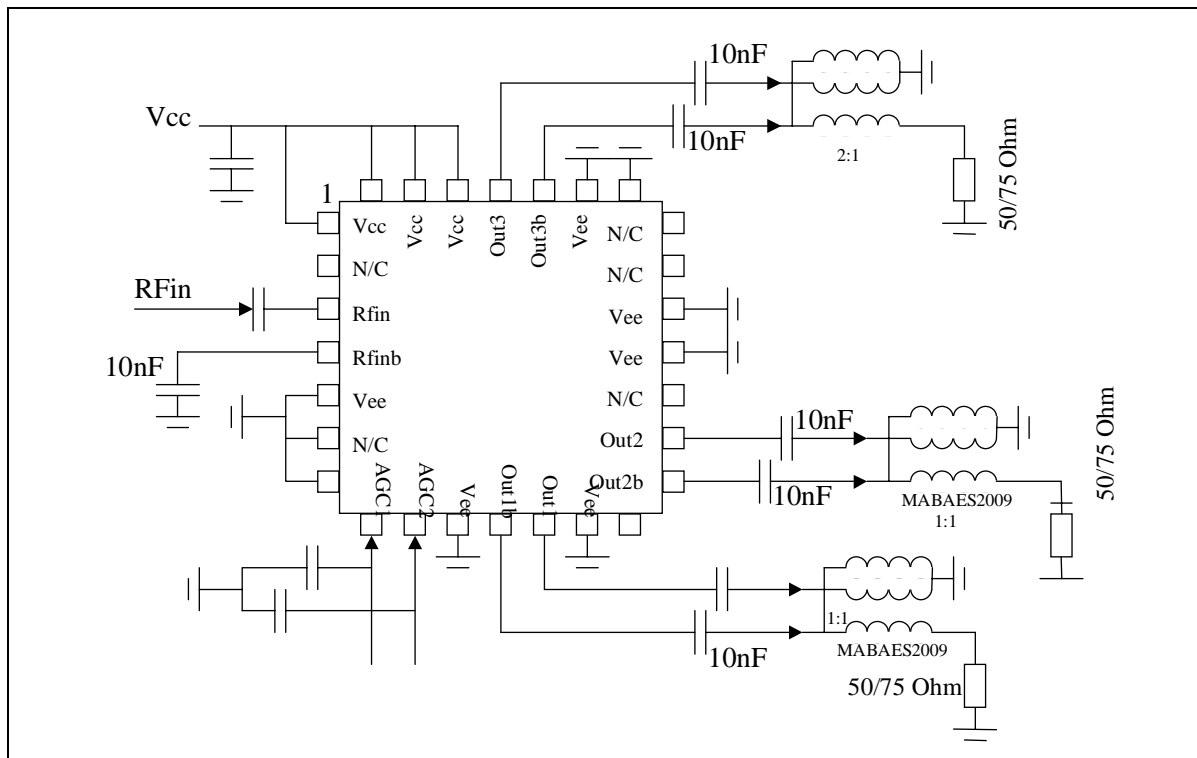

Figure 3 - Application Diagram - A (Differential)

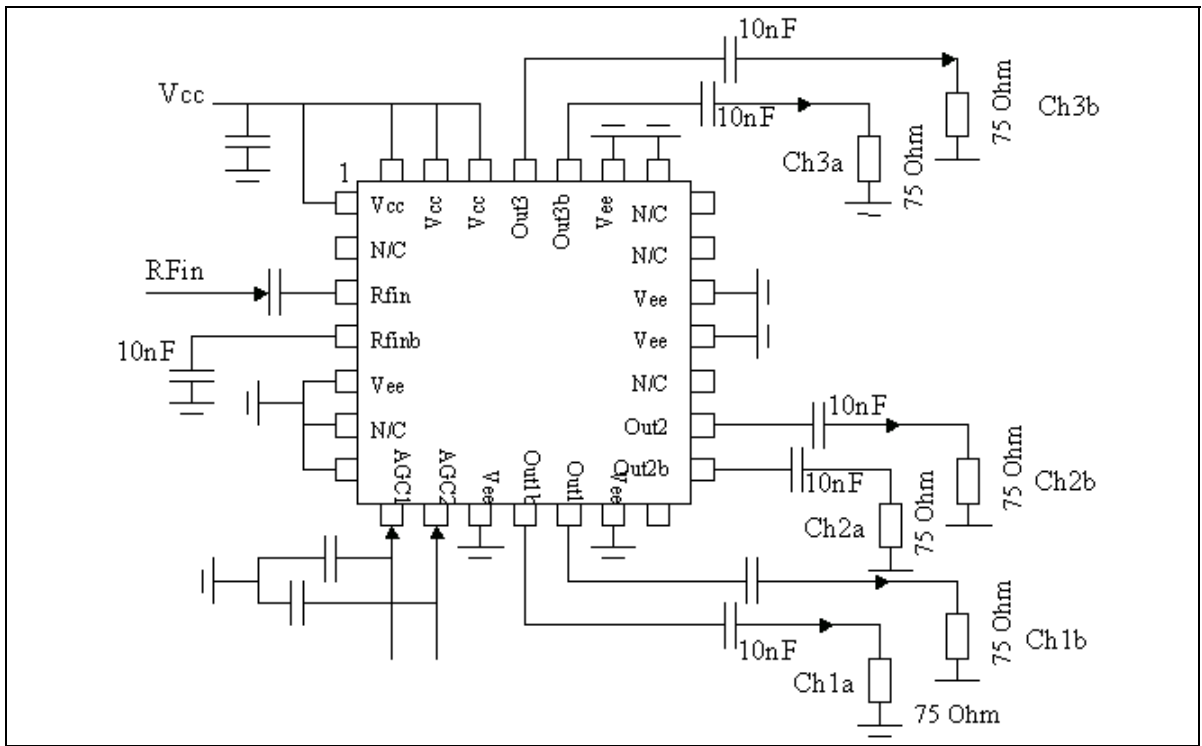

Figure 4 - Application Diagram B (Single Ended)

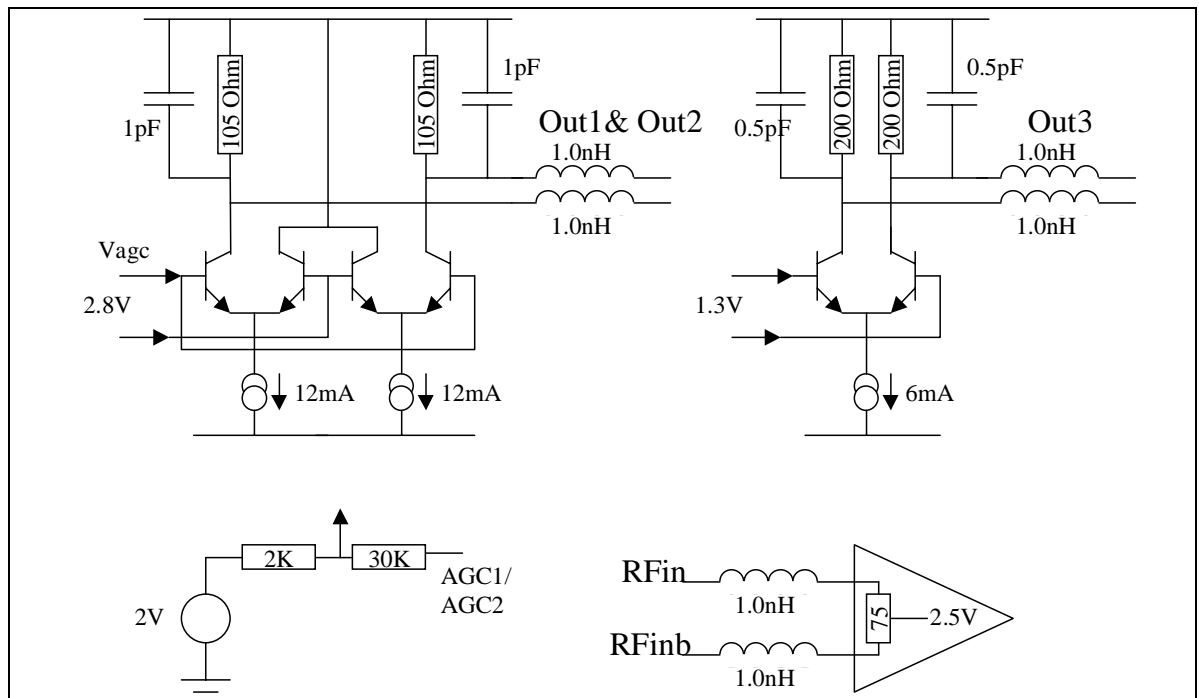

Figure 5 - ZL40000 I/O Circuits

**Absolute Maximum Ratings**

Characteristic	Min	Max	Units	Comments
Supply Voltage (Vcc)	- 0.5	6	V	
RFin		12	dBm	
All I/O ports	-0.5V	Vcc+0.5	V	
Storage Temperature	-55	150	°C	
Junction Temperature		125	°C	
ESD protection	2KV			Mil-std 883B / 3015 cat1

**Operating Range**

Characteristic	Min	Typ	Max	Units	Comments
Supply Voltage (Vcc)	4.75		5.25	V	
AGC1	0		5.25	V	
AGC2	0		5.25	V	
RFin Frequency Range	0.1		2000	MHz	
Operating Junction Temperature	-40		+120	°C	
Junc'n to Amb't resistance Theta Ja		50		°C/W	4 layer FR4 Board
Junc'n to Case resistance Theta Jc		20		°C/W	4 layer FR4 Board

**DC Electrical Characteristics** - Vcc=5V +/- 0.25V, Tamb = -40C to 80C, unless otherwise spec'd.

Characteristic	Min	Typ	Max	Units	Comments
Supply Current		100	130	mA	
Power Dissipation		500	683	mW	
RFin, RFinb DC Level		Vcc/2		V	
Out1, Out1b DC Level		Vcc-1.2		V	AGC1 = 0V
Out2, Out2b DC Level		Vcc-1.2		V	AGC2 = 0V
Out3, Out3b DC Level		Vcc-0.5		V	

**AC Electrical Characteristics** -  $V_{cc}=5V \pm 0.25V$ ,  $T_{amb} = -40C$  to  $80C$ , unless otherwise spec'd.

Characteristic	Min	Typ	Max	Units	Comments
Diff RFin impedance		75		Ohm	
S11		6		dB	(See Figure 36) (10MHz to 1000MHz)
Diff Out1 impedance		200		Ohm	
Diff Out2 impedance		200		Ohm	
Diff Out3 impedance		400		Ohm	
S21 Gain1 (Out1/RFin)	3.5	6.5	9.5	dB	100 Ohm Diff load, AGC1=0V (Max Gain)
S21 Gain2 (Out2/RFin)	3.5	6.5	9.5	dB	100 Ohm Diff load, AGC1=0V (Max Gain)
S21 Gain3 (Out3/RFin)	-3.5	-0.5	-2.5	dB	200 Ohm Diff load,
Gain Matching (Gain1 - Gain2)	-0.5	0	0.5	dB	AGC1 = AGC2 = 0V (Max Gain)
Gain Matching (Gain1- Gain2)	-0.5		0.5	dB	Gain1 = Gain2 = 5dB to 0dB, Figure 16 & Figure 18.
Gain Matching (Gain1 - Gain2)	-2		2	dB	Gain1 = Gain2 = 0dB to -25dB, Figure 17 & Figure 19 (Temp = 0C to 80C)
NF (Out1 & Out2)		7.5		dB	Figure 32 & Figure 33 (Gain = Max)
NF (Out1 & Out2)		12		dB	Figure 32 & Figure 33 (Gain = 0dB)
NF (Out1 & Out2)		15		dB	Figure 32 & Figure 33 (Gain = -5dB)
NF (Out1 & Out2)		18		dB	Figure 32 & Figure 33 (Gain = -10dB)
RFin P-dB compression	-2	0		dBm	
CMRR		40		dB	
AGC Range (Out1 & Out2)	40			dB	
AGC -3dB BW		45		MHz	
AGC Switching Time		15		ns	Max Gain to Min Gain ( $V_{agc}=0.8V$ to $4.2V$ )
AGC input referred Noise		200		nV/rt Hz	(Includes 26dB agc input resistor attenuator)
IIP3_100MHz		20		dBm	Figure 26 & Figure 27
IIP3_500MHz		17		dBm	Figure 26 & Figure 27
IIP3_1000MHz		13		dBm	Figure 26 & Figure 27
IIP3 variance / AGC	-1		1	dB	Gain = 5dB to - 10dB, Figure 28 & Figure 29
IIP2_50MHz		55		dBm	Figure 20 & Figure 21 (0dB Gain)
IIP2_500MHz		42		dBm	Figure 20 & Figure 21 (0dB Gain)
Isolation (Output to Output)		50		dB	Balanced to Balanced
Isolation (output to output)		25			Single Ch1 to Single Ch2 Output
S21 (Output to Input)			-40	dB	Balanced to Balanced

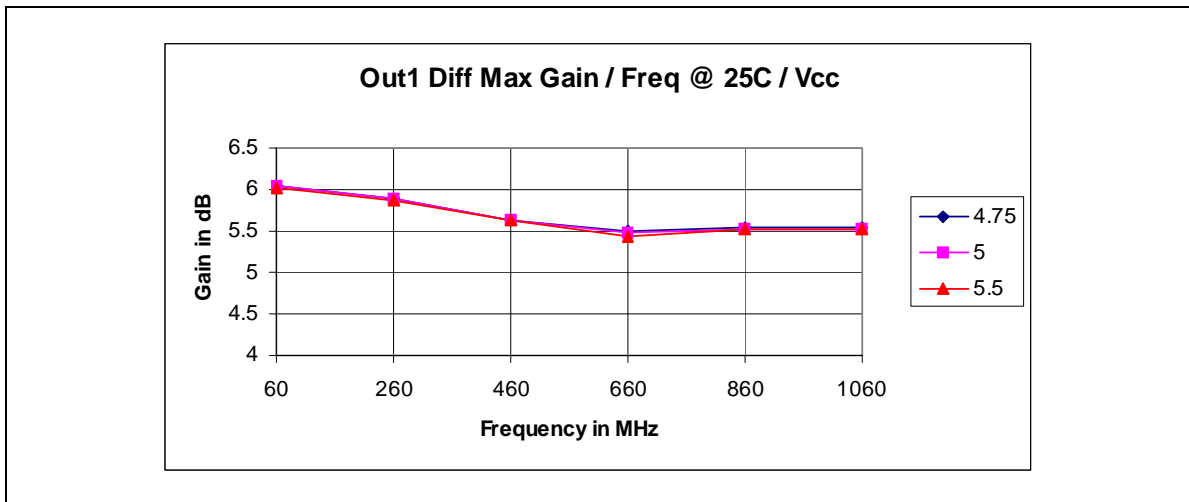

Figure 6 - Typical Ch1&2 Diff Gain / Freq / Vcc @ 25C

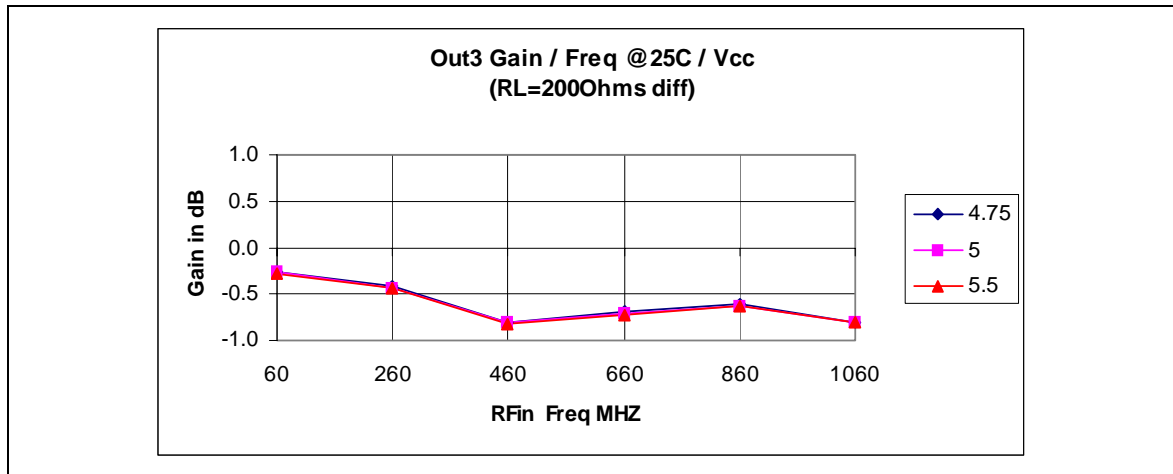

Figure 7 - Typical Ch3 Diff Gain / Freq / Vcc @ 25C

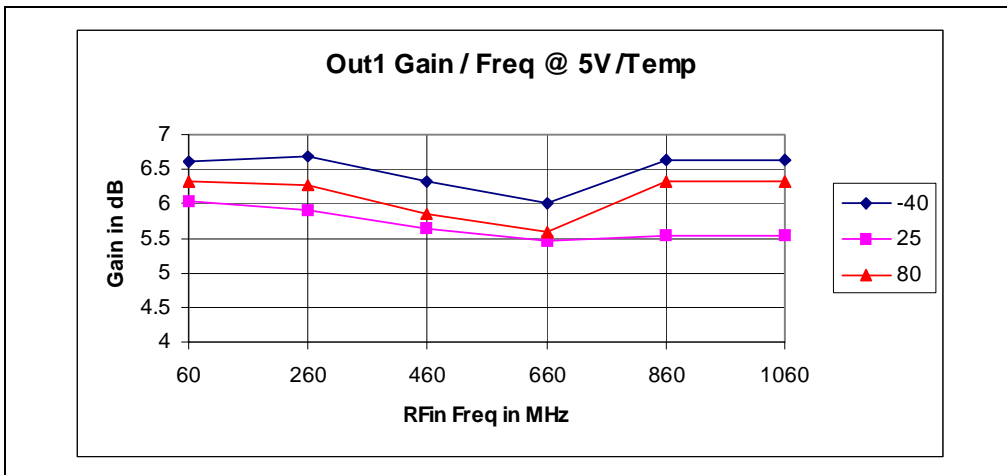

Figure 8 - Typical Ch1 & Ch2 Diff Max Gain / Freq / Temp @ 5V Vcc

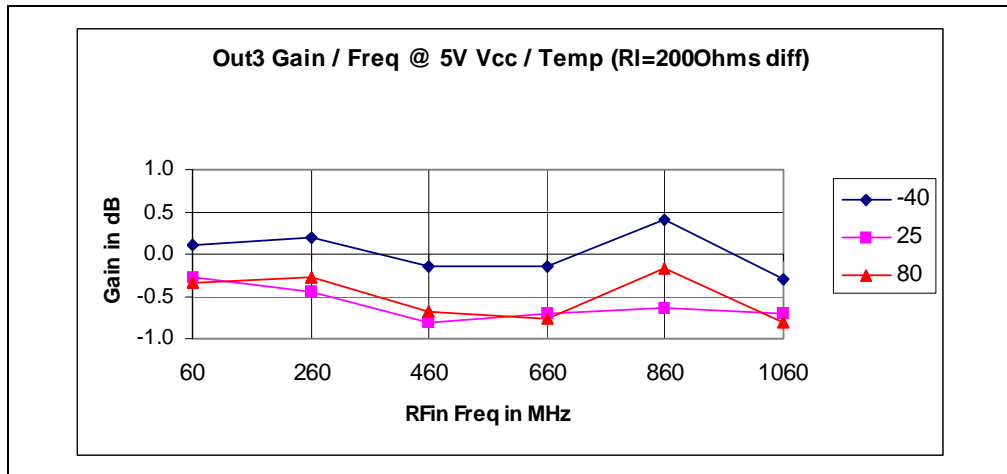

Figure 9 - Typical Ch3 Gain / Freq @ 5V / Temp (R1=200 Ohm)

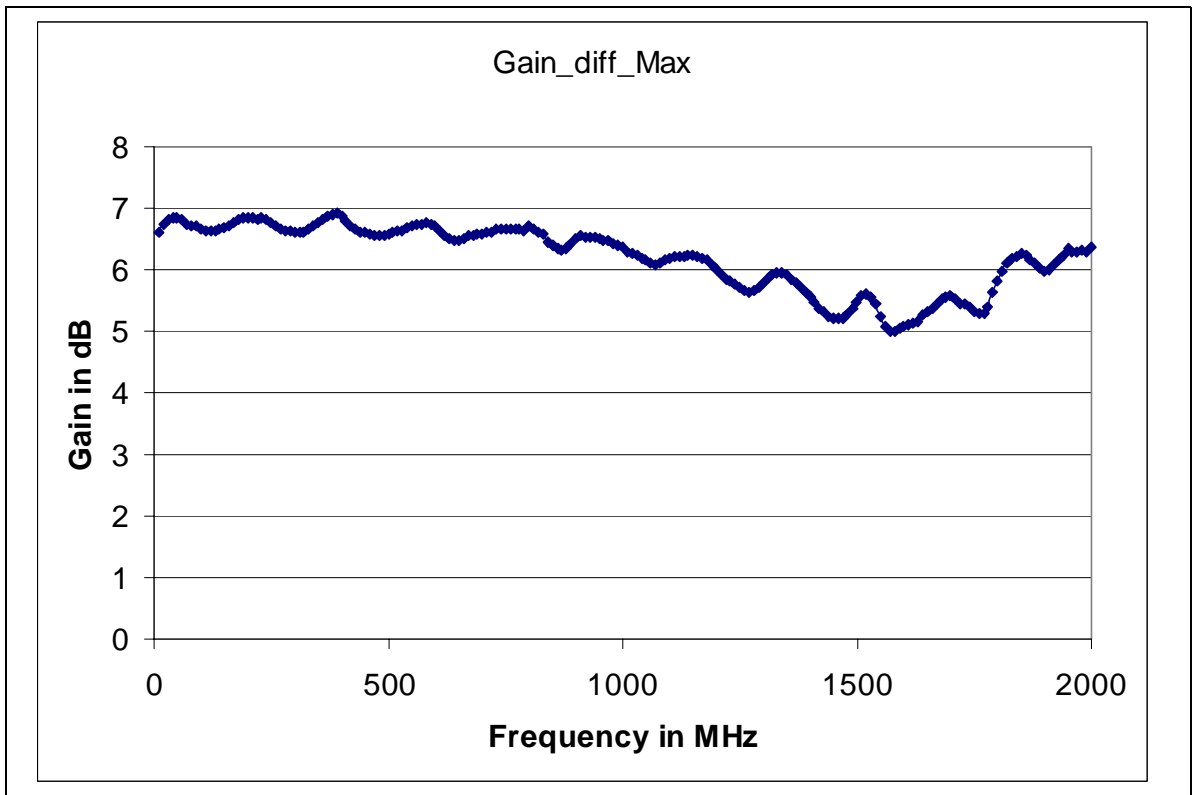

Figure 10 - Typical Diff Max Gain / Frequency

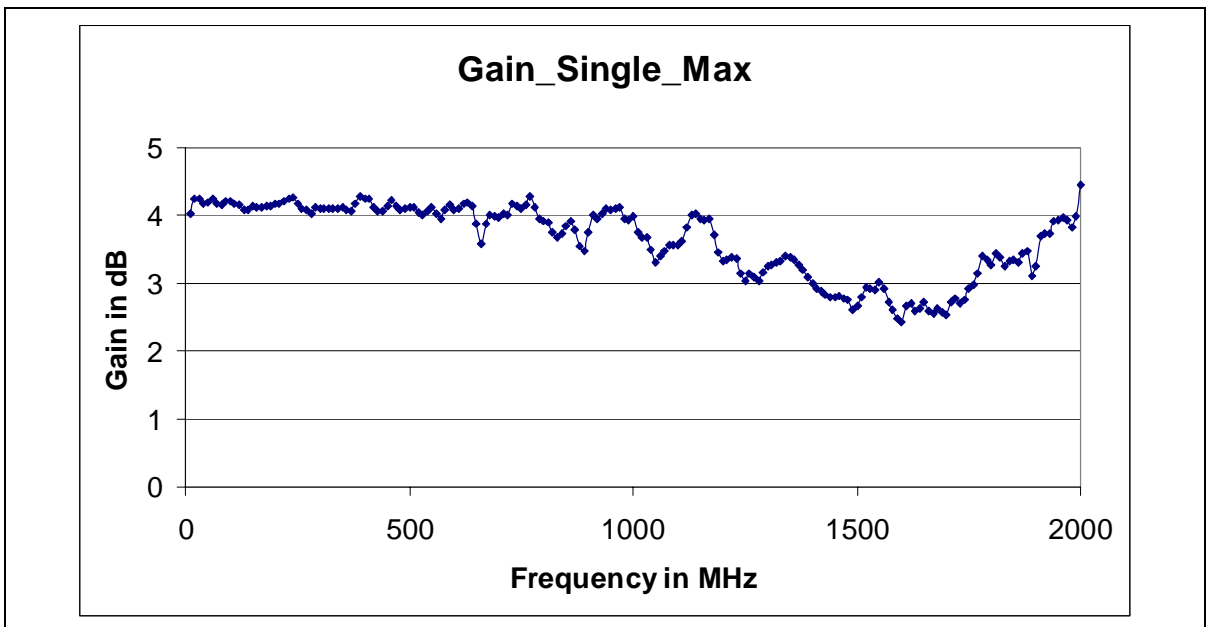

Figure 11 - Typical Single Ended Max Gain / Frequency



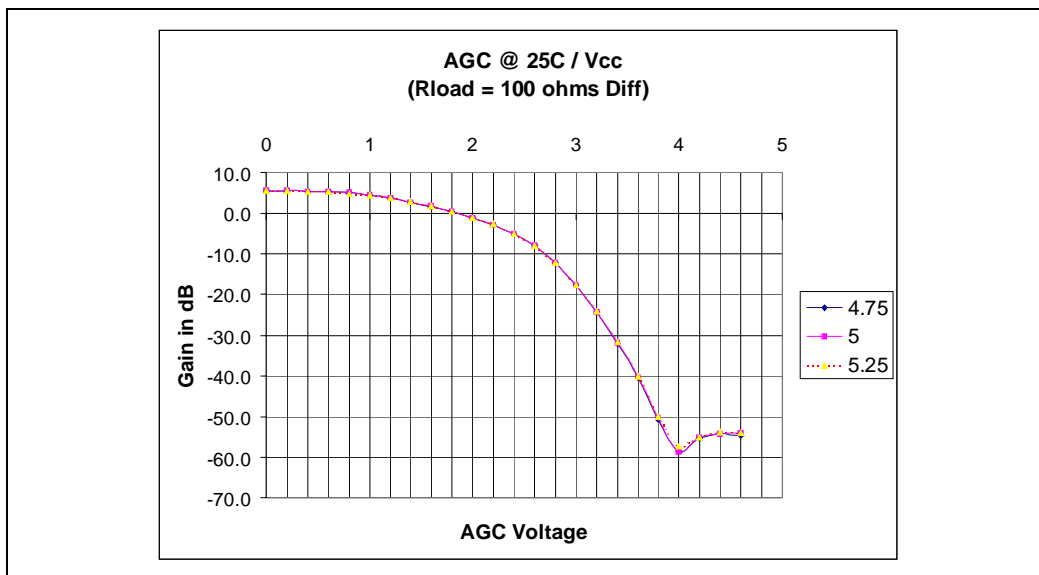

Figure 12 - Typical AGC / VCC @ 25C

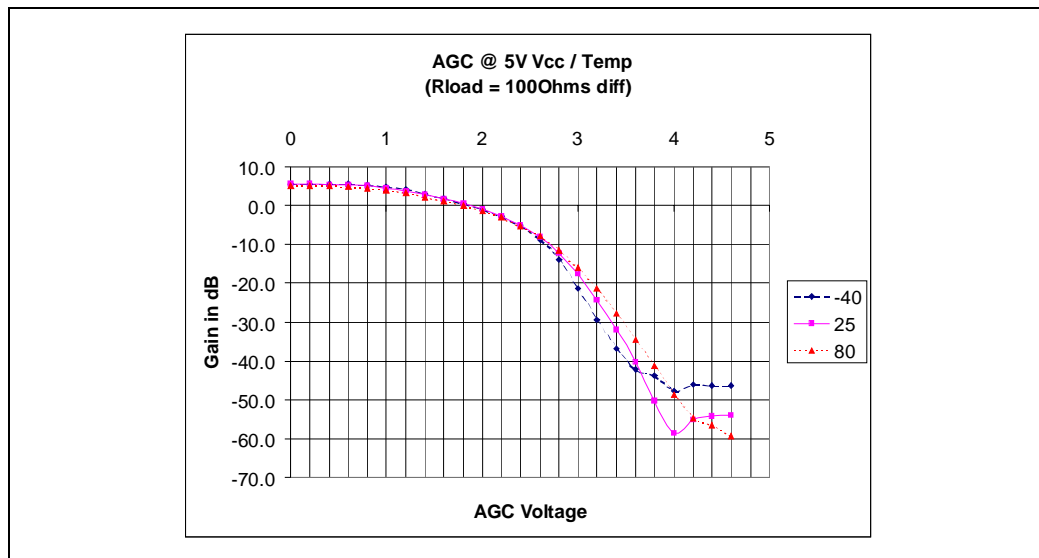

Figure 13 - Typical AGC / Temp @ 5 V Vcc

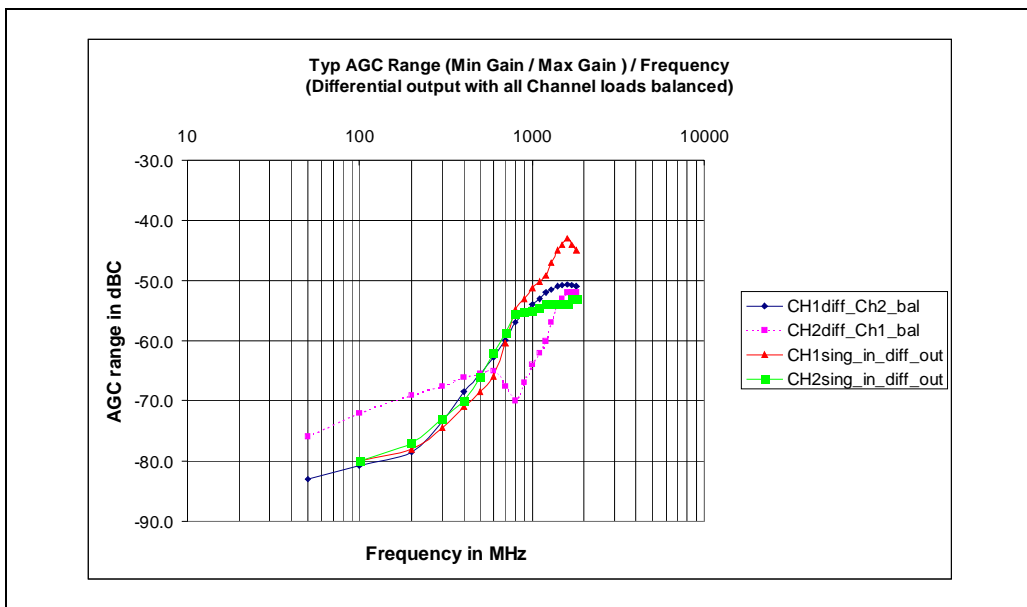

Figure 14 - Typical AGC Range / Frequency (Differential Output with all channel loads balanced)

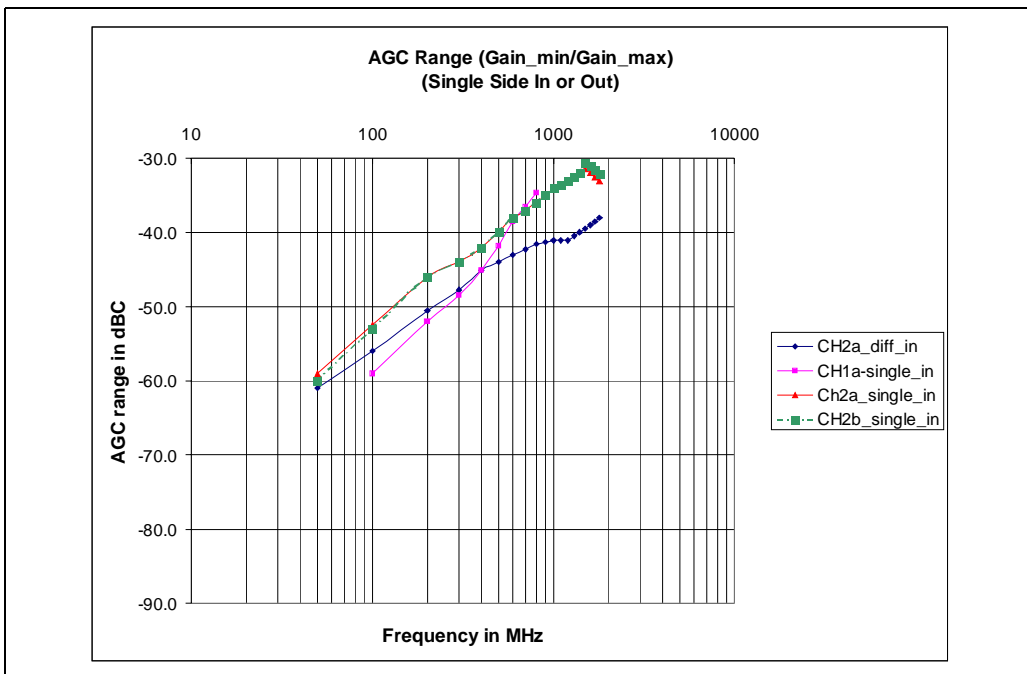

Figure 15 - Typical AGC Range / Frequency (Single Ended output)

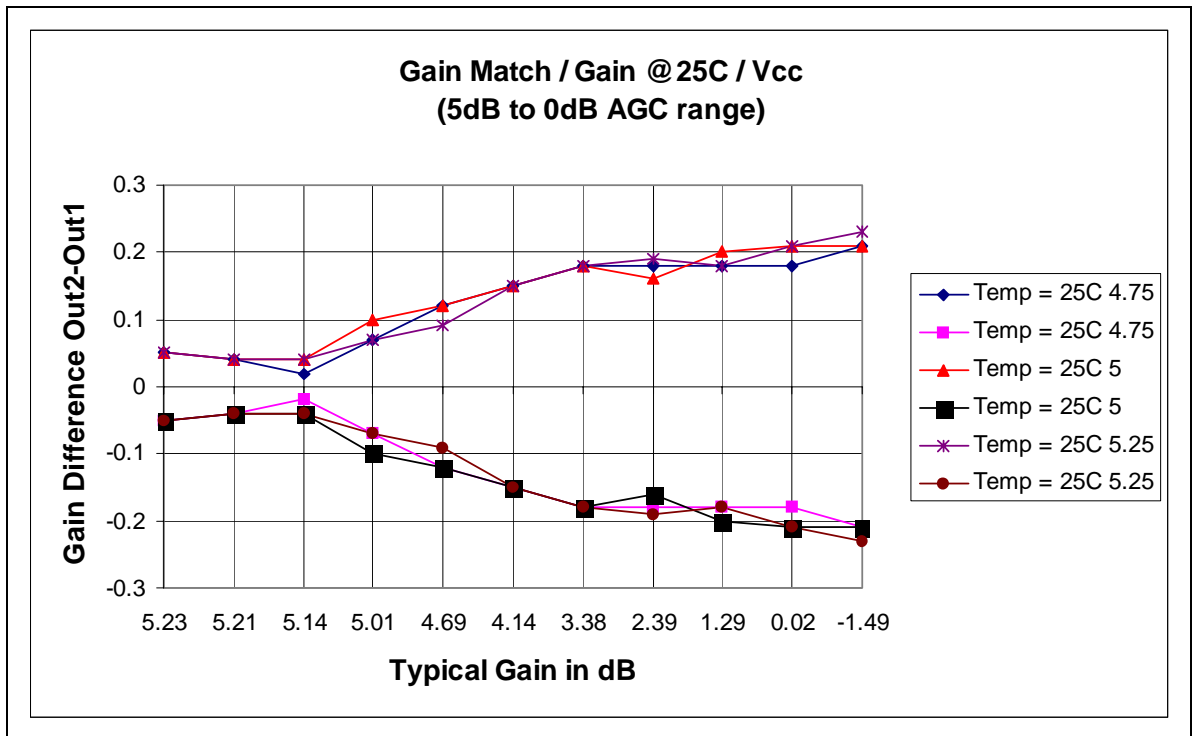

Figure 16 - Typical Gain Matching / AGC @ 25C / Vcc

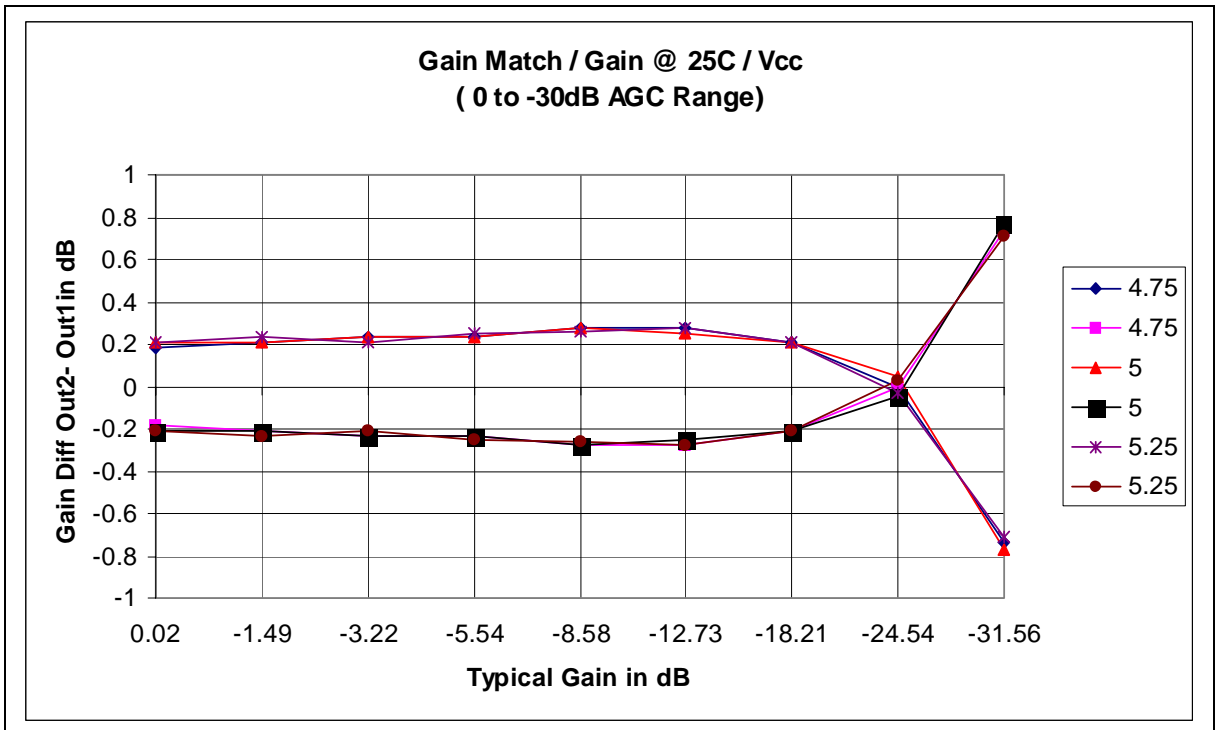

Figure 17 - Typical Gain Match 1 to 2 / Gain @ 25C / Vcc

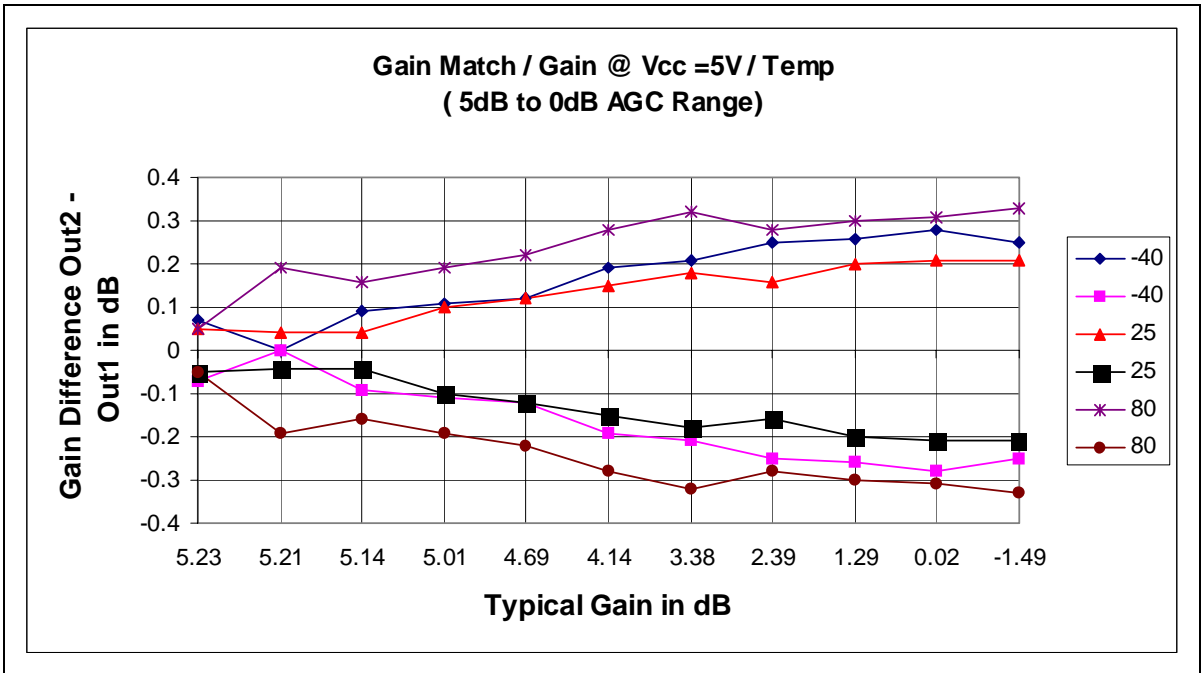

Figure 18 - Typical Gain Matching / AGC @ 5V Vcc / Temp

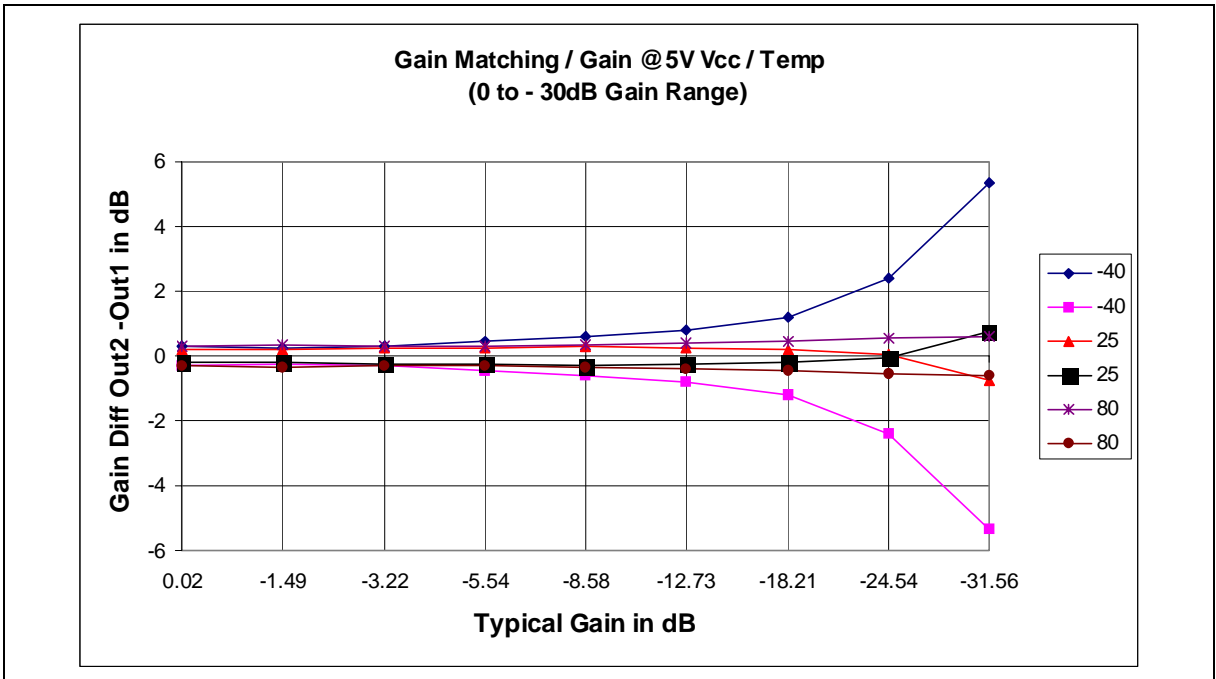

Figure 19 - Typical Gain Matching / AGC @ 5V Vcc / Temp

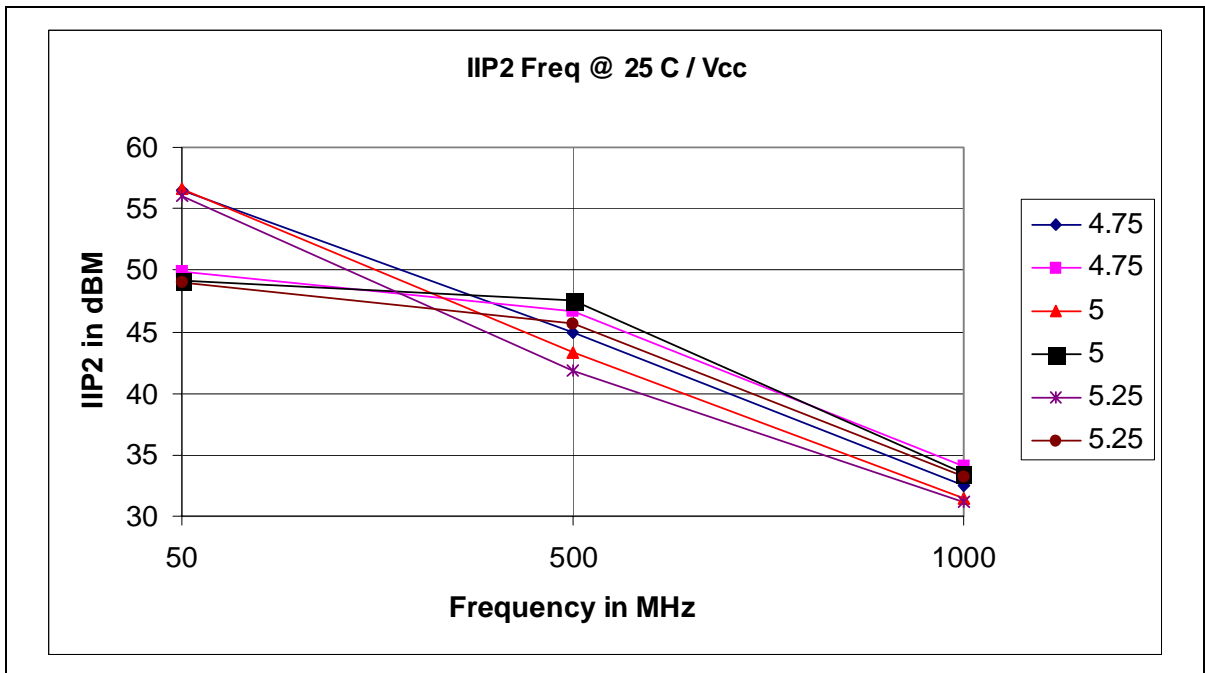

Figure 20 - Typical Out1 @ Out2 IIP2 / Frequency @ Max Gain @ 25C / Vcc

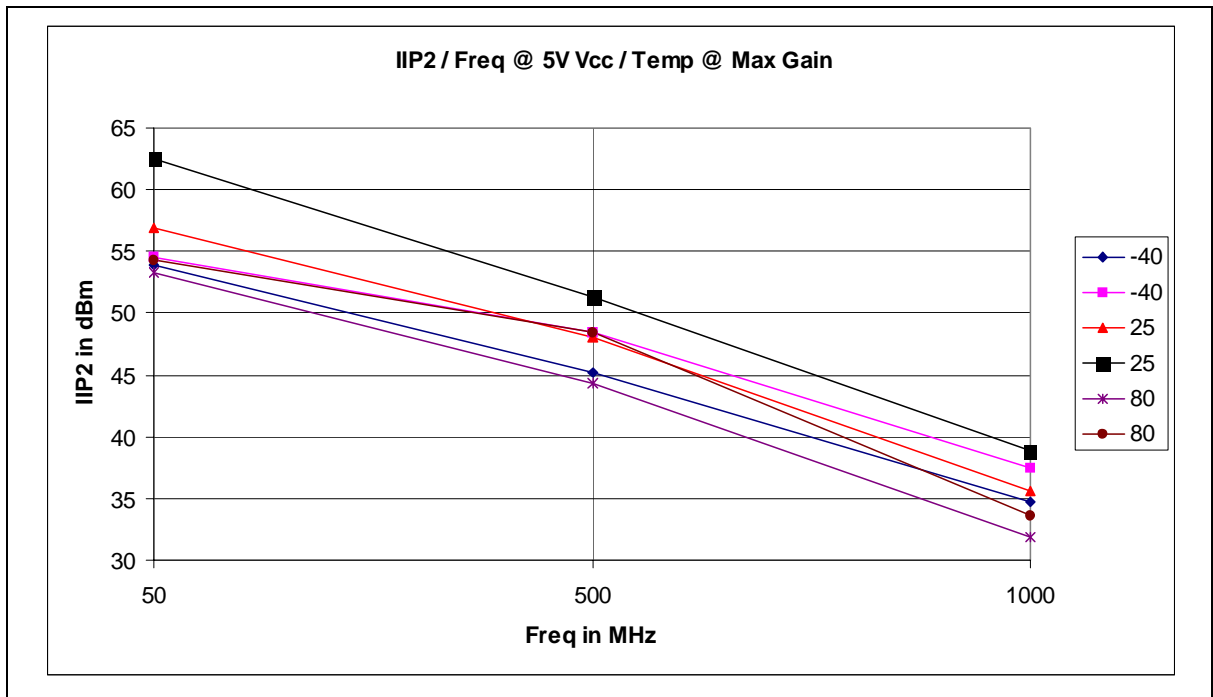

Figure 21 - Typical Out1 @ Out2 IIP2 / Frequency @ Max Gain @ 5V Vcc / Temp

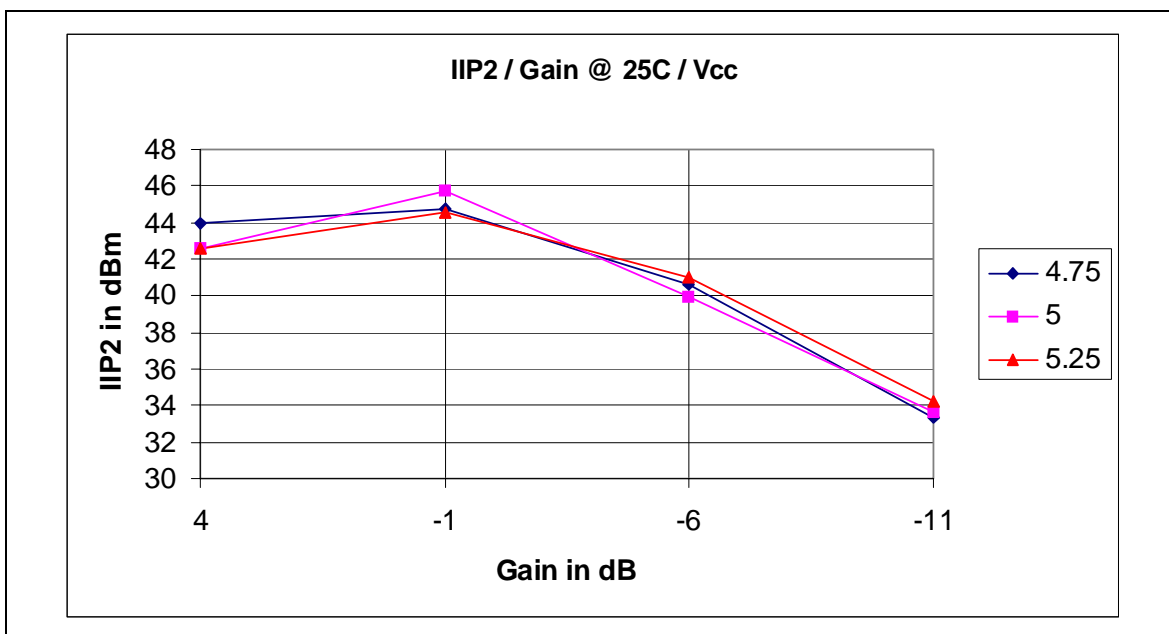

Figure 22 - Typical IIP2 / Gain @ 25C / Vcc @ 500MHz

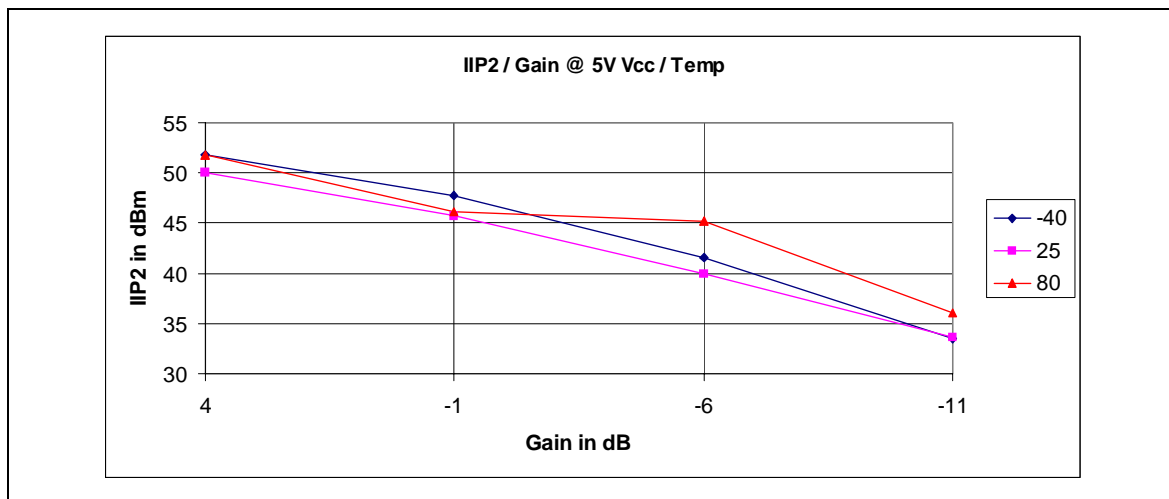

Figure 23 - Typical IIP2 / Gain @ 5V Vcc / Temp @ 500MHz

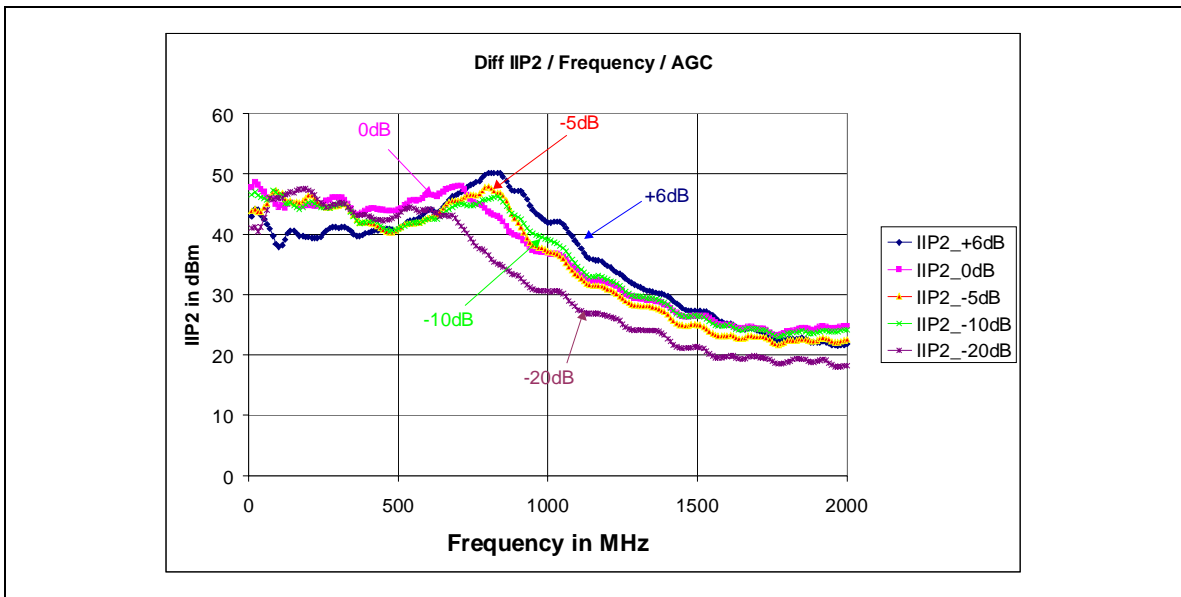

Figure 24 - Typical Differential IIP2 / Frequency / AGC Setting

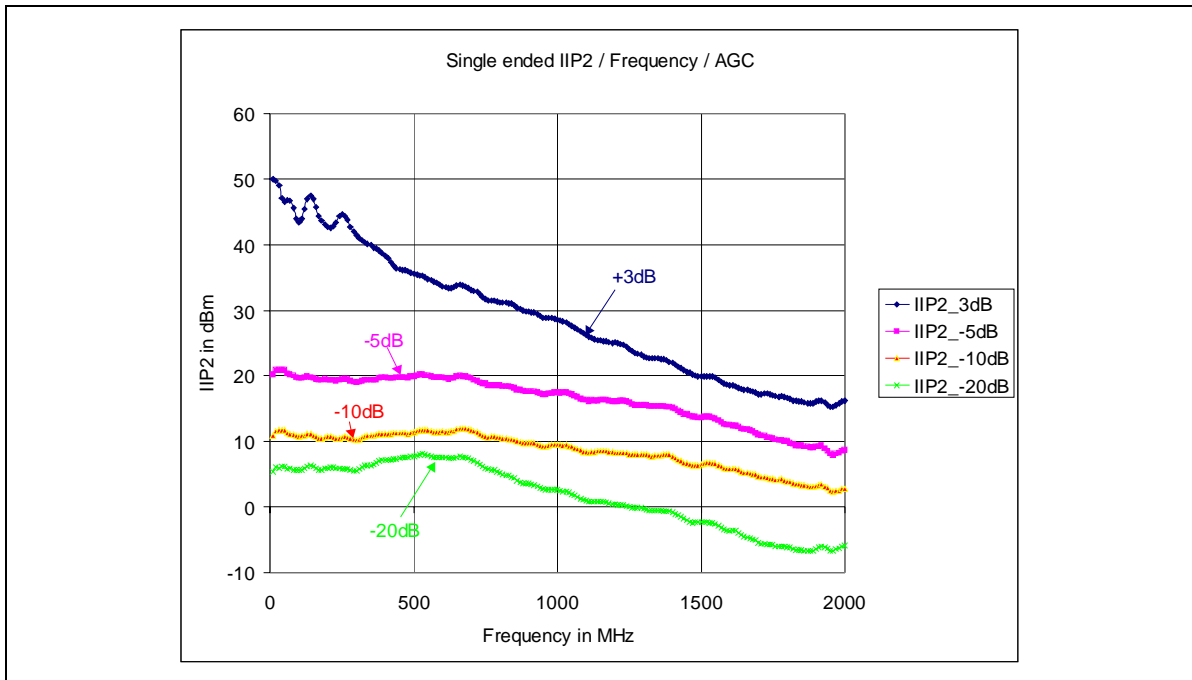

Figure 25 - Typical Single Ended IIP2 / Frequency / AGC

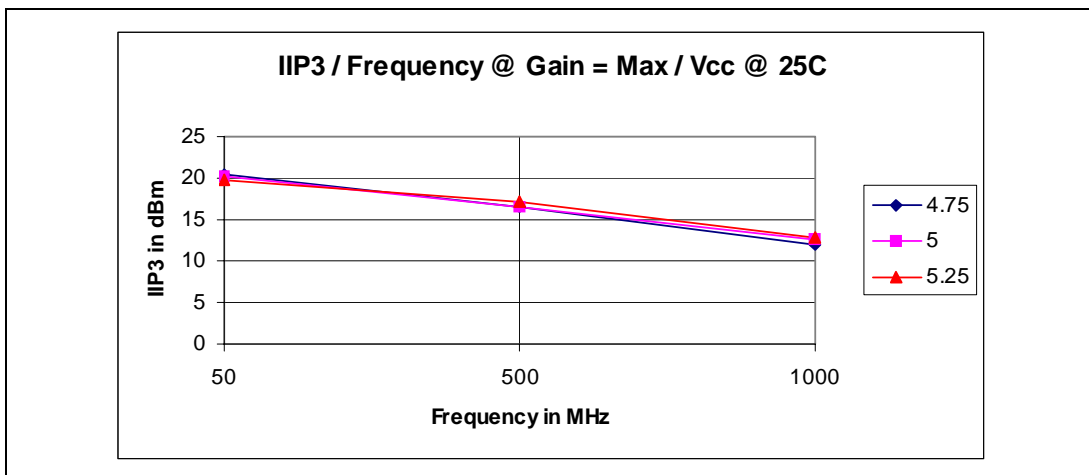

Figure 26 - Typical Out1, Out2 & Out3 IIP3 / Frequency @ Gain = Max / Vcc @ 25C

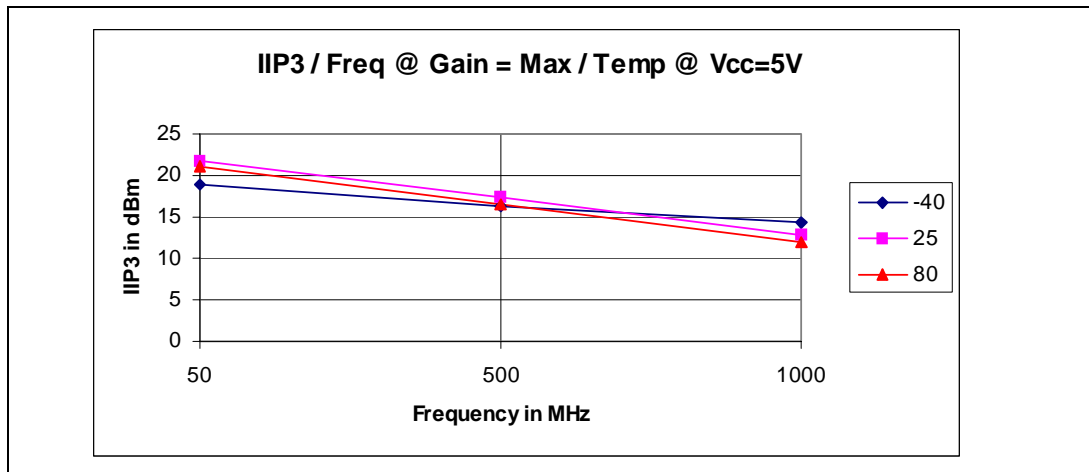

Figure 27 - Typical Out1, Out2 & Out3 IIP3 / Frequency @ Gain = Max / Temp @ 5V Vcc



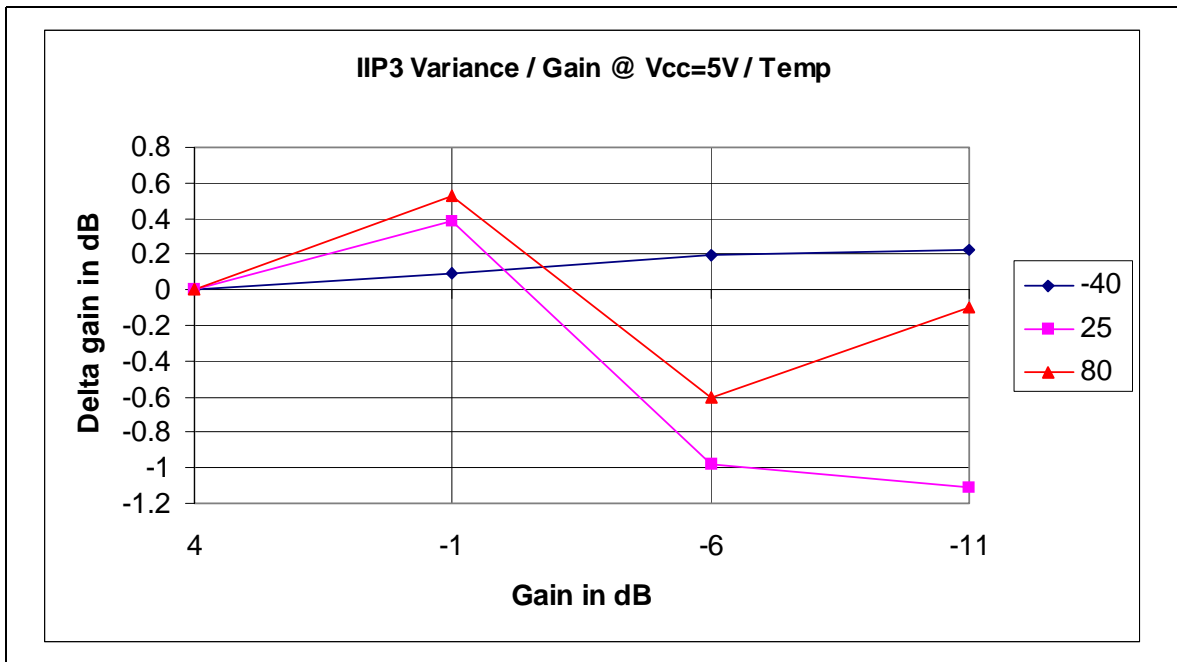

Figure 28 - Typical IIP3 Variance with AGC @ Vcc=5V /Temp @ 400MHz

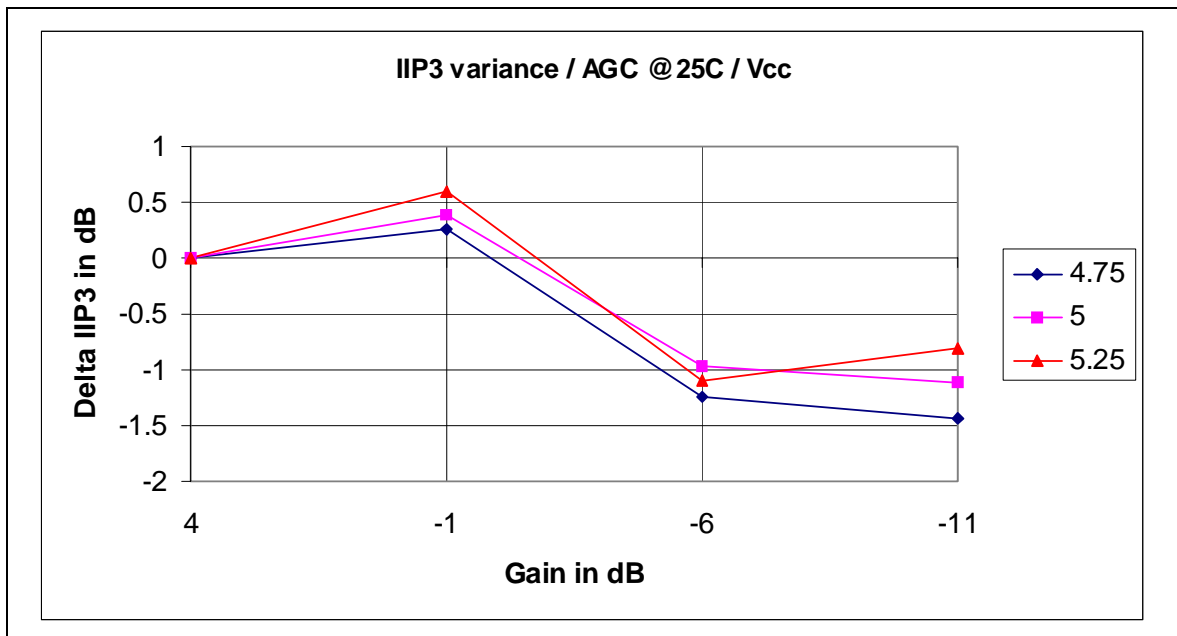

Figure 29 - Typical IIP3 variance with AGC @ 25C / Vcc @ 400MHz

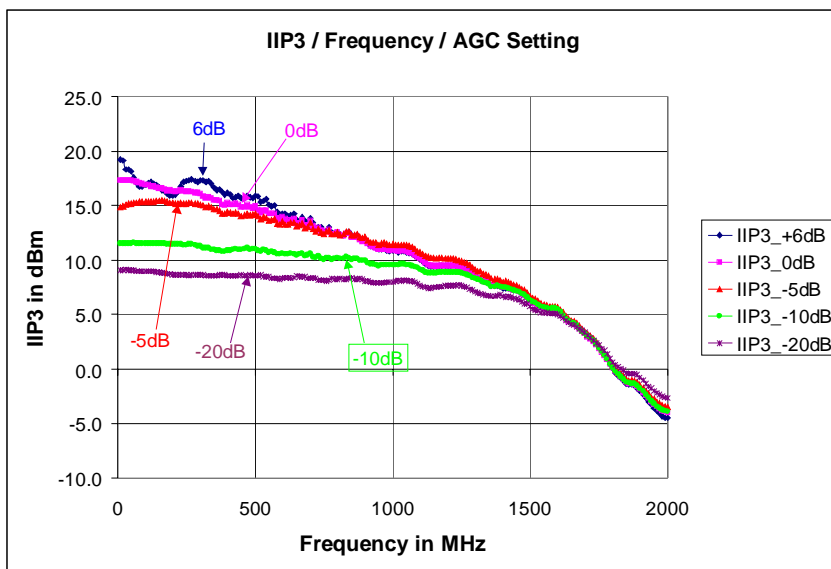

Figure 30 - Typical IIP3 @ Max Gain Differential / Frequency

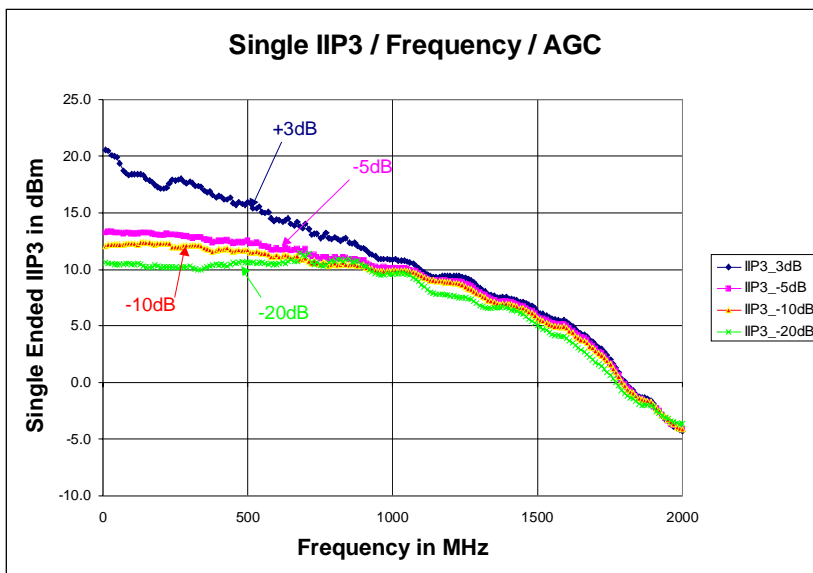

Figure 31 - Typical IIP3 Single Ended / Frequency / AGC

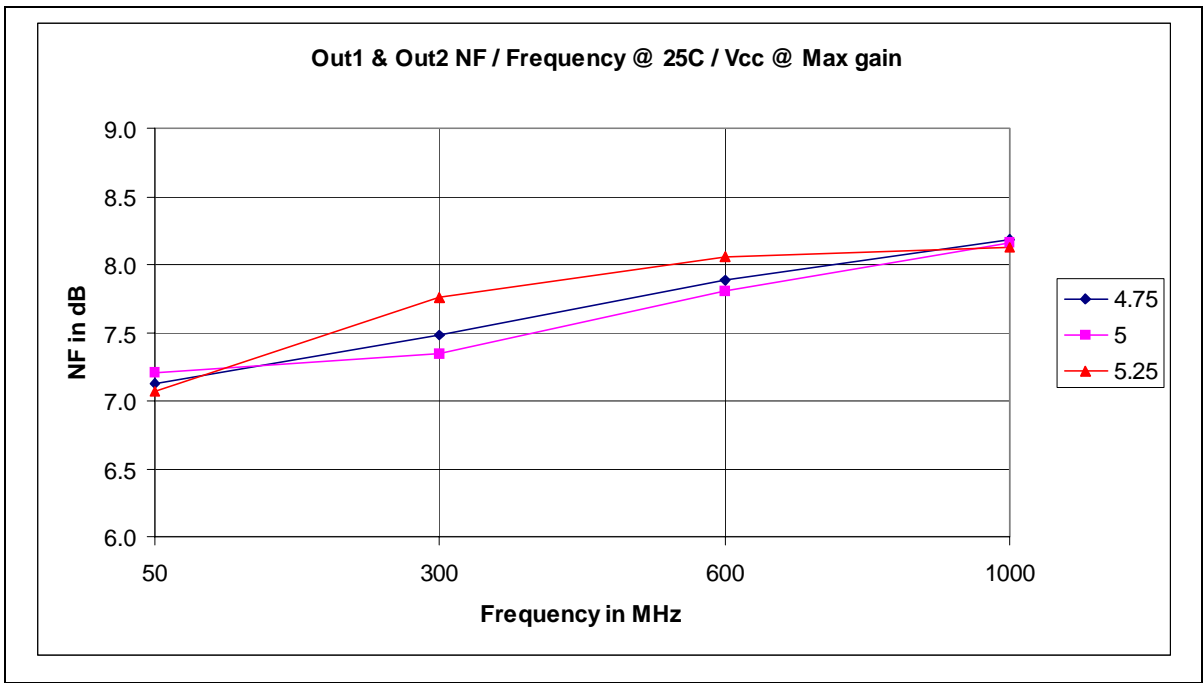

Figure 32 - Typical Differential NF / Frequency @ 25C / Vcc @ Max Gain

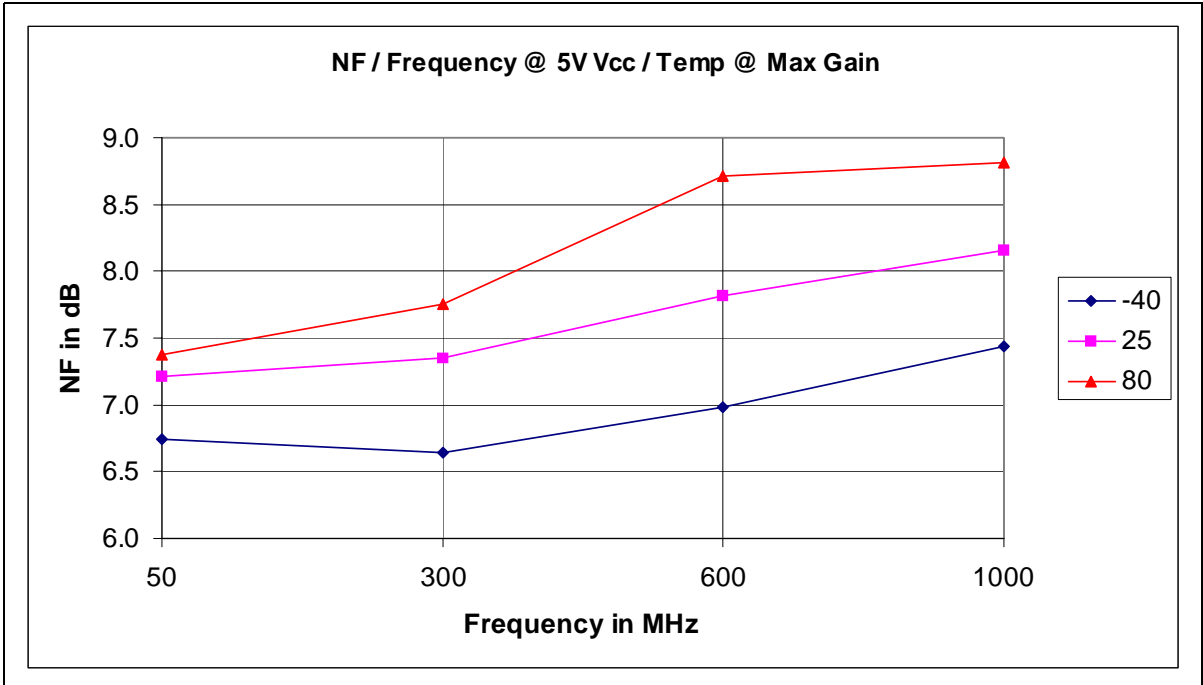

Figure 33 - Typical Differential NF / Frequency @ 5V Vcc / Temp @ Max Gain

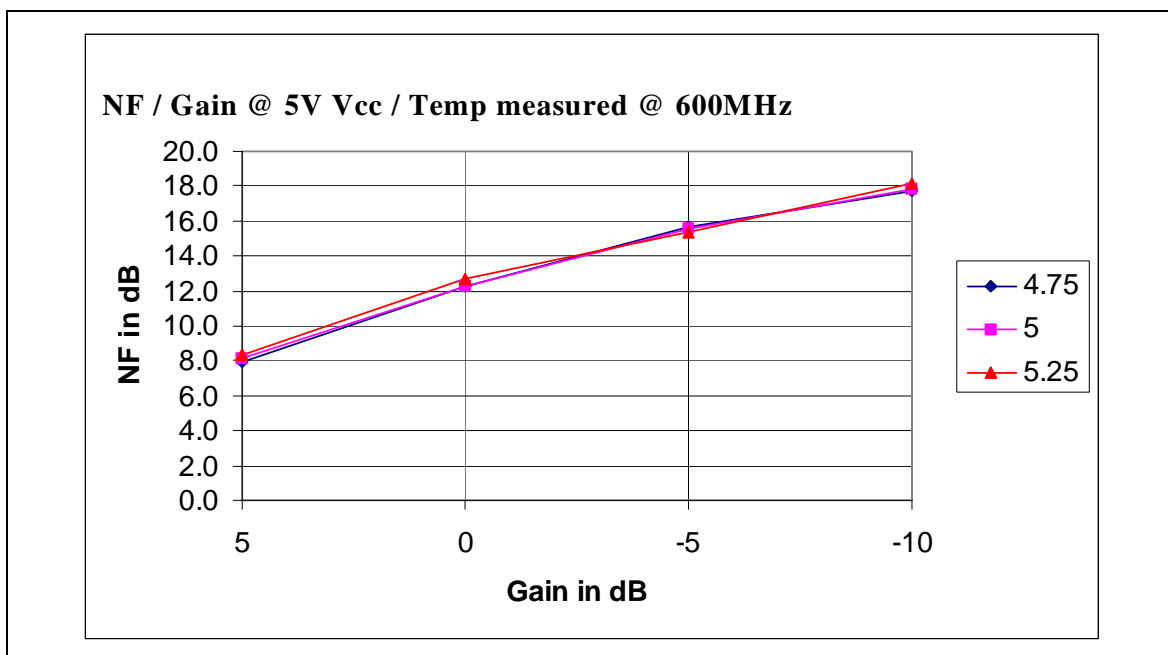

Figure 34 - Typical Differential NF / Gain @ 5V Vcc / Temp measured @ 600MHz

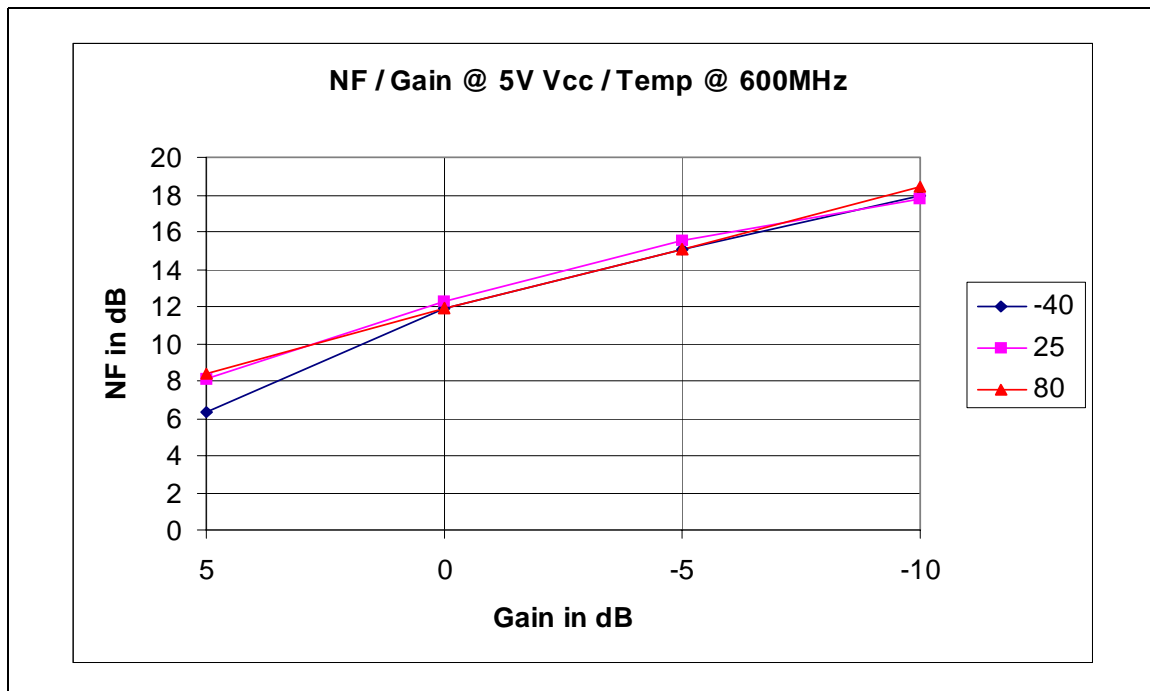

Figure 35 - Typical Differential NF / Gain @ 25C / Vcc measured @ 600MHz

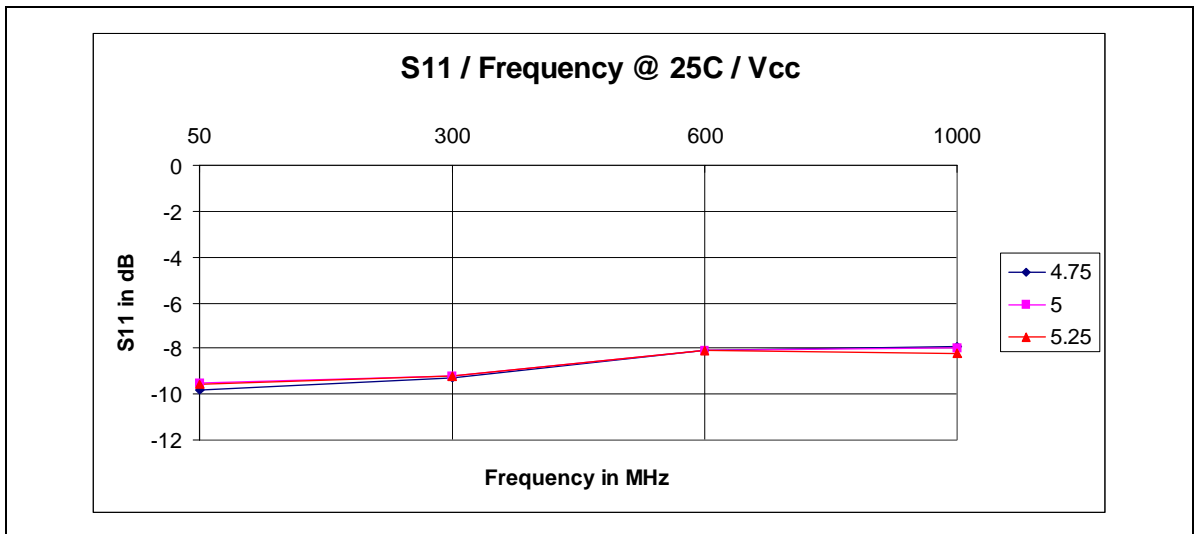

Figure 36 - Typical S11 in 50Ohm System

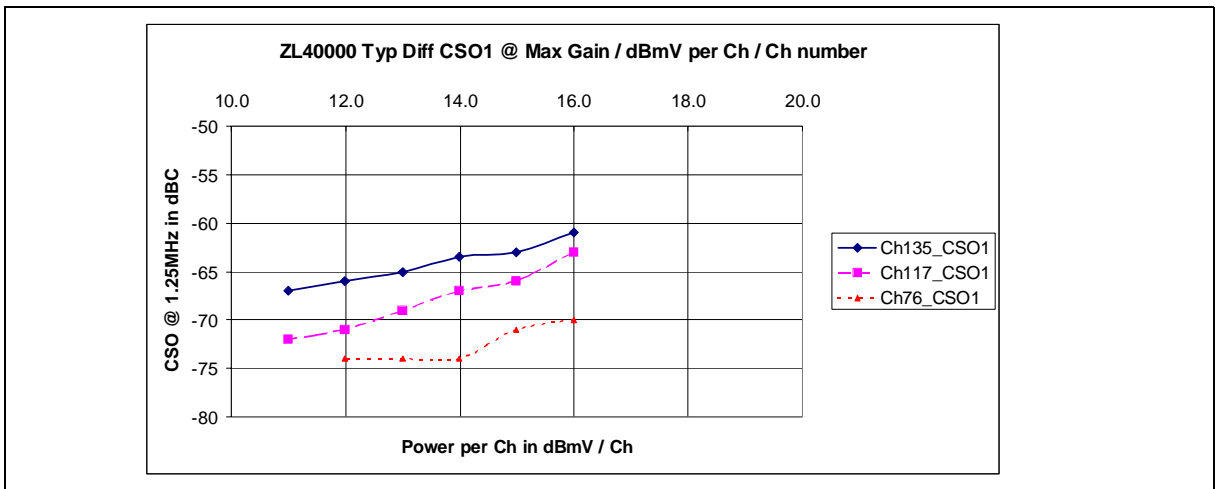
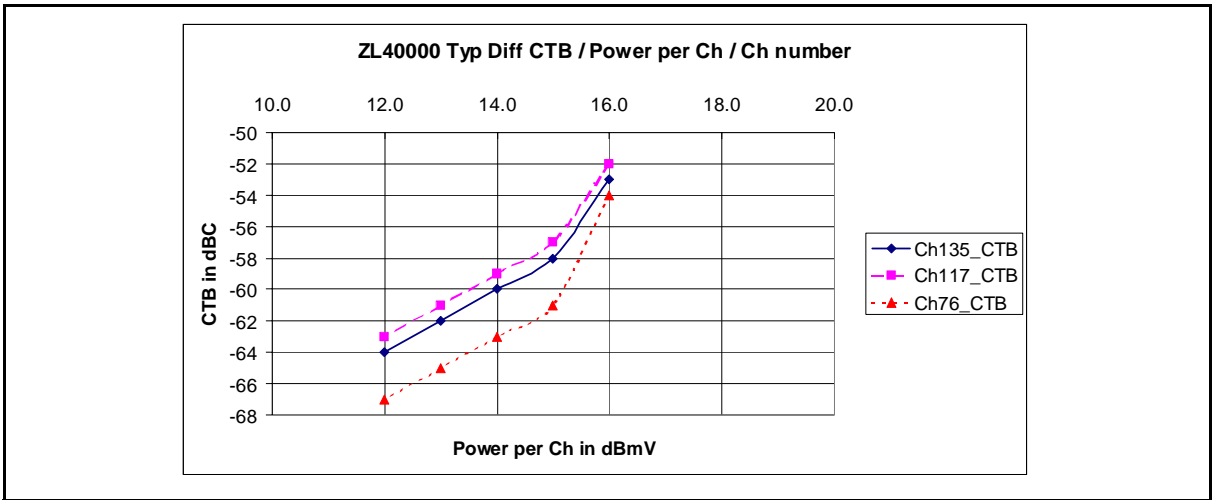

Figure 37 - Typical Differential CSO / Level per Channel @ Max Gain

CH136, CH117 and CH76 @ 850MHz, 745MHZ and 499MHz respectively) (Composite signal contains 130 Channels at 6MHz spacing between 50MHz and 850 MHz)



**Figure 38 - Typical Differential CTB / Level per Channel @ Max Gain**

CH136, CH117 and CH76 @ 850MHz, 745MHz and 499MHz respectively) (Composite signal contains 130 Channels at 6MHz spacing between 50MHz and 850 MHz)

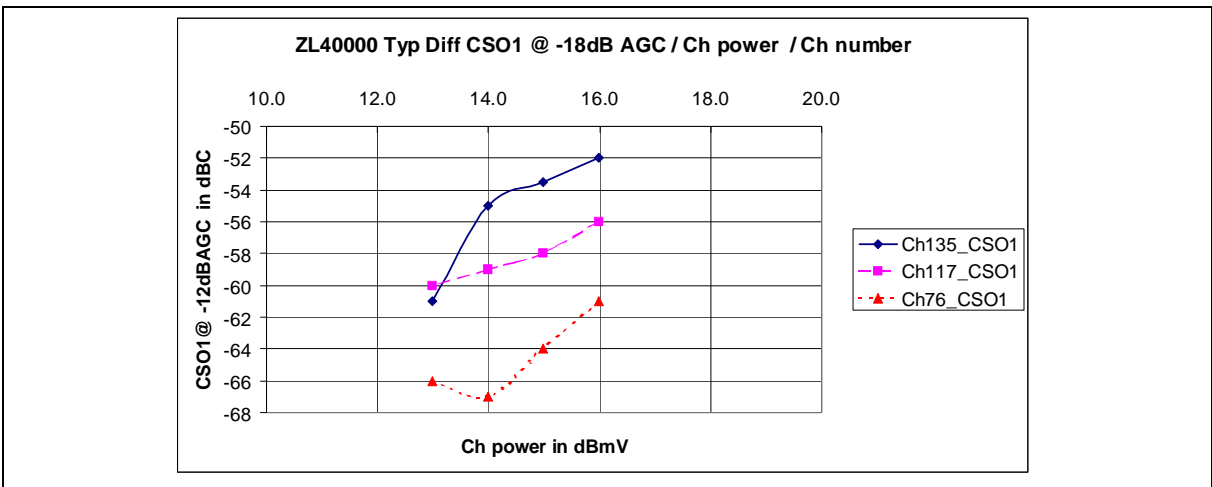

**Figure 39 - Typical Differential CSO / Level per Channel @ -12dB Gain**

(CH136, CH117 and CH76 @ 850MHz, 745MHz and 499MHz respectively) (Composite signal contains 130 Channels at 6MHz spacing between 50MHz and 850 MHz)

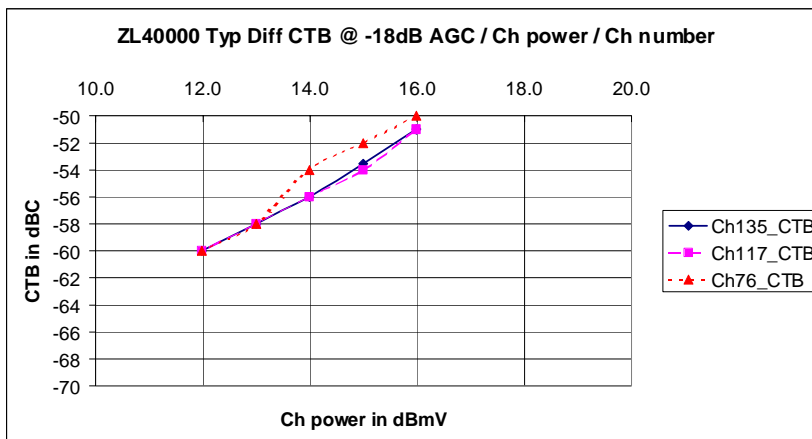

**Figure 40 - CH136, CH117 and CH76 @ 850MHz, 745MHZ and 499MHz respectively**

(Composite signal contains 130 Channels at 6MHz spacing between 50MHz and 850 MHz)

**Applications Notes**

The ZL40000 is a wide band RF signal conditioning and distribution circuit that can be used in many applications. The device has excellent signal handling performance and provides > 40 dB of AGC range over the full operating BW of DC to 2GHz.

The device excellent dynamic performance and wide bandwidth make the device ideally suited to providing a separate buffered RF multi carrier signal to multiple tuner applications such as can be found in next generation Set Top Boxes, VCRs, DVDs and TVs for Digital Terrestrial, Cable and Satellite.

The device will also satisfy Analogue Terrestrial, Cable and Satellite requirements up to -35dBm / Ch in 130 Carrier Composite signals from 50MHz to 850 MHz with 6MHz channel spacing.

The very high signal handling RF AGC stage makes the ZL40000 suitable for use in all wide dynamic range receiver systems operating in the 1MHz to 2GHz band.

The ZL40000 has excellent RF AGC performance providing > 40dB AGC range over the full DC to 2GHz operating range. The RF AGC range exceeds 60dB from DC to 500MHz.

Both the excellent RF AGC range and the excellent Multi Carrier performance are achieved as a result of the balanced nature of the circuit. The ZL40000 can be operated both single ended or differential at both the input and the output.

The performance achieved with the output signal used differential, increases the RF isolation and adds 20dB improvement above that achieved single ended. It also greatly reduces the second order distortion and inter modulation present at the output.

The best performance is achieved when all output ports are connected to balanced loads and if a particular channel is to be used single ended output, the unused output should be terminated with a matching load.

The excellent RF range and high BW AGC control port makes the ZL40000 suitable for applications in which fast level control or RF Signal Switching is required such as may be found in Instrumentation.

The RF AGC attenuator can be switched through 60dB of AGC range typically 15nS.

A pair of ZL4000 with cross coupled outputs and a broad band quadrature phase shift unit can be used to build a broad band RF phase rotator that could be used in Agile Active Antenna Arrays for Transmitters with fast beam steering.



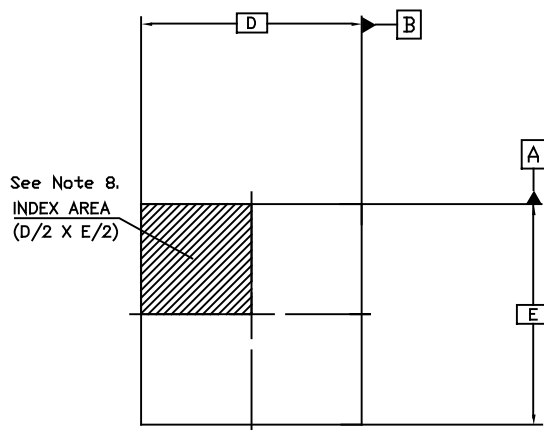

TOP VIEW

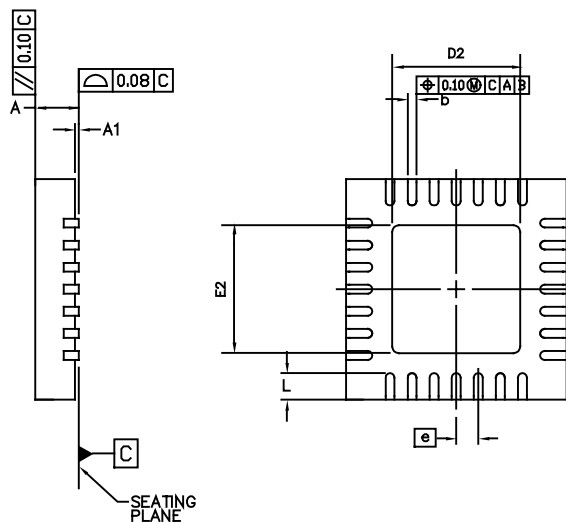

BOTTOM VIEW

SYMBOL	COMMON DIMENSIONS	
	MIN.	MAX.
A	—	1.00
A1	0.00	0.05
b	0.18	0.30
D	4.925	5.075
D2	3.00	3.25
E	4.925	5.075
E2	3.00	3.25
N	28	
Nd	7	
Ne	7	
$\square$	0.50 BSC	
L	0.35	0.75

Conforms to JEDEC MO-220 VHHD-1 iss A

- NOTES:
1. DIMENSIONING & TOLERANCES CONFORM TO ASME Y14.5M. – 1994.
  2. N IS THE NUMBER OF TERMINALS.  
Nd & Ne ARE THE NUMBER OF TERMINALS ON EACH D AND E SIDE RESPECTIVELY
  3. DIMENSION b APPLIES TO PLATED TERMINAL AND IS MEASURED BETWEEN 0.25 AND 0.30mm FROM TERMINAL.
  4. ALL DIMENSIONS ARE IN MILLIMETERS.
  5. LEAD COUNT IS 28 .
  6. PACKAGE WARPAGE MAX 0.08mm.
  7. NOT TO SCALE.
  8. TERMINAL #1 IDENTIFIER MUST BE LOCATED WITHIN THE ZONE INDICATED AND MAY BE EITHER A MOULD OR MARKED FEATURE.

© Zarlink Semiconductor 2006. All rights reserved.

ISSUE	2	3	4	5
ACN	212494	212973	CDCA	CDCA
DATE	8Apr02	21Jun02	6Jan05	23Jan06
APPRD.				



Previous package codes

LH

Package Code **LC**

Package Outline for 28 Lead QFN (5 x 5mm)

**GPD00747**



**For more information about all Zarlink products  
visit our Web Site at  
[www.zarlink.com](http://www.zarlink.com)**

Information relating to products and services furnished herein by Zarlink Semiconductor Inc. or its subsidiaries (collectively "Zarlink") is believed to be reliable. However, Zarlink assumes no liability for errors that may appear in this publication, or for liability otherwise arising from the application or use of any such information, product or service or for any infringement of patents or other intellectual property rights owned by third parties which may result from such application or use. Neither the supply of such information or purchase of product or service conveys any license, either express or implied, under patents or other intellectual property rights owned by Zarlink or licensed from third parties by Zarlink, whatsoever. Purchasers of products are also hereby notified that the use of product in certain ways or in combination with Zarlink, or non-Zarlink furnished goods or services may infringe patents or other intellectual property rights owned by Zarlink.

This publication is issued to provide information only and (unless agreed by Zarlink in writing) may not be used, applied or reproduced for any purpose nor form part of any order or contract nor to be regarded as a representation relating to the products or services concerned. The products, their specifications, services and other information appearing in this publication are subject to change by Zarlink without notice. No warranty or guarantee express or implied is made regarding the capability, performance or suitability of any product or service. Information concerning possible methods of use is provided as a guide only and does not constitute any guarantee that such methods of use will be satisfactory in a specific piece of equipment. It is the user's responsibility to fully determine the performance and suitability of any equipment using such information and to ensure that any publication or data used is up to date and has not been superseded. Manufacturing does not necessarily include testing of all functions or parameters. These products are not suitable for use in any medical products whose failure to perform may result in significant injury or death to the user. All products and materials are sold and services provided subject to Zarlink's conditions of sale which are available on request.

Purchase of Zarlink's I<sup>2</sup>C components conveys a licence under the Philips I<sup>2</sup>C Patent rights to use these components in and I<sup>2</sup>C System, provided that the system conforms to the I<sup>2</sup>C Standard Specification as defined by Philips.

Zarlink, ZL and the Zarlink Semiconductor logo are trademarks of Zarlink Semiconductor Inc.

Copyright Zarlink Semiconductor Inc. All Rights Reserved.

**TECHNICAL DOCUMENTATION - NOT FOR RESALE**

---