

Peak Sensitivity Wavelength: 940nm

The MT03-001 is a circular ($\varnothing 2.52$) 5mm² active area Photodiode in a hermetic TO-5 metal can package. It is well suited for applications requiring high sensitivity (Green/Blue) as well as visible-near IR applications.

FEATURES

- > Ultra Low Noise
- > High Shunt Resistance
- > Wide Dynamic Range
- > Blue Enhanced

APPLICATIONS

- > Colorimeters
- > Photometers
- > Spectroscopy Equipment
- > Fluorescence

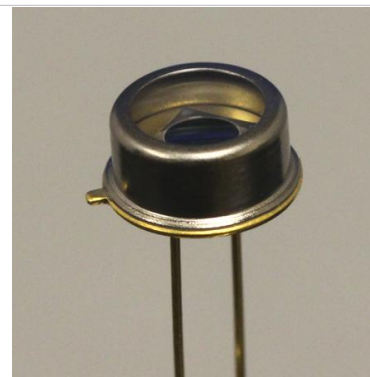

Absolute Maximum Ratings



ITEMS	SYMBOL	RATINGS	UNIT
Reverse Voltage	VR	50	V
Operating Temperature Range	Topr	-40 ~ +100	°C
Storage Temperature Range	Tstg	-55 ~ +125	°C
Lead Soldering Temperature*1	Tls	260	°C

*1: Time 5 Sec max, Position: Up to 3mm from the body.

Electrical & Optical Characteristics (Ta = 25°C)

ITEMS	SYMBOL	CONDITIONS	MIN	TYP	MAX	UNIT
Light Current	IL	*1, *2	--	--	10.0	mA
Dark Current	ID	VR=10V	--	--	1.0	nA
Spectral Sensitivity	λ	--	--	400~1100	--	nm
Peak Sensitivity Wavelength	λ_p	--	--	940	--	nm
Responsivity	Rt	VR=0V, $\lambda=410$ nm	--	0.22	--	A/W
Responsivity	Rt	VR=0V, $\lambda=940$ nm	--	0.60	--	A/W
Response Time @410nm	Tr	RL=50 Ω , Vr=10V	--	2.0	--	nS
Junction Capacitance	Cj	at 1MHz, V=0V	--	65	70	pF
Junction Capacitance	Cj	at 1MHz, V=5V	--	14	18	pF
Shunt Resistance	Rs	Vr=10mV	400	600	--	m Ω

*1: Color Temperature=2870°K Standard Tungsten Lamp, *2: VR=10V, Ee=5mW/cm².

TO-5 Package Dimensions (2 Pin)

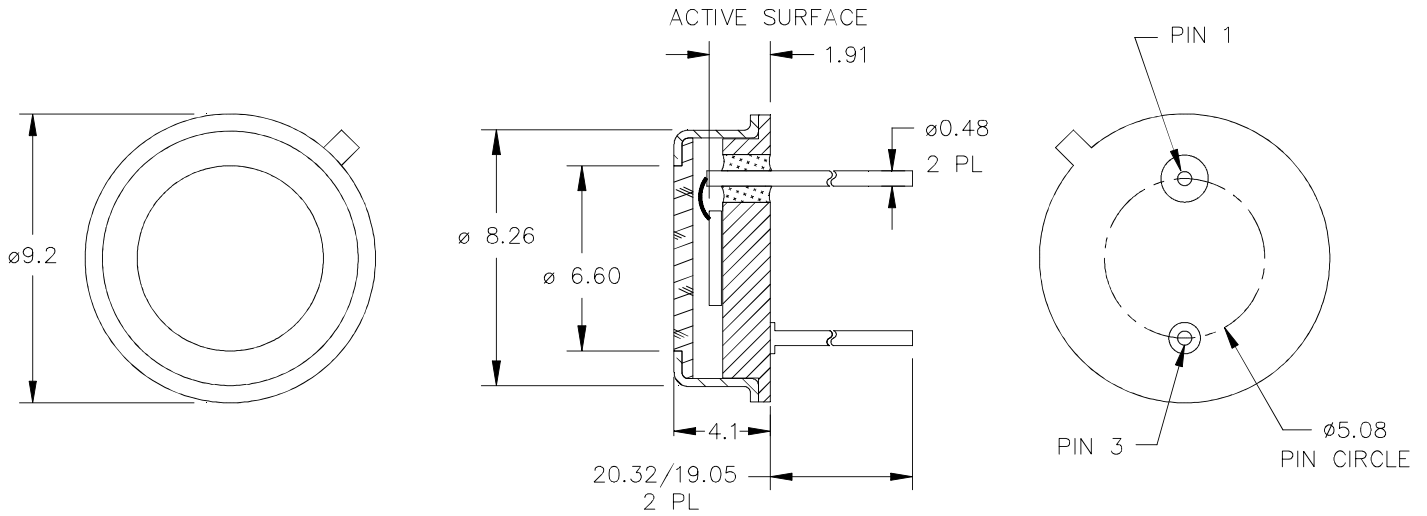

Unit: mm, Tolerance: ± 0.2

Capacitance as Function of Reverse Bias (23°C)

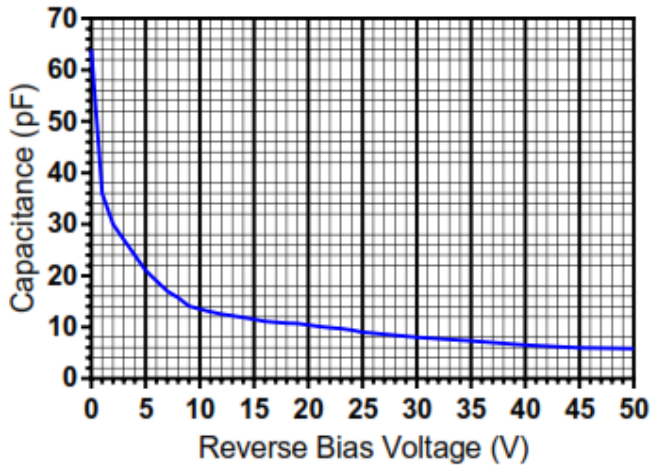

Dark Current as Function of Bias (23°C)

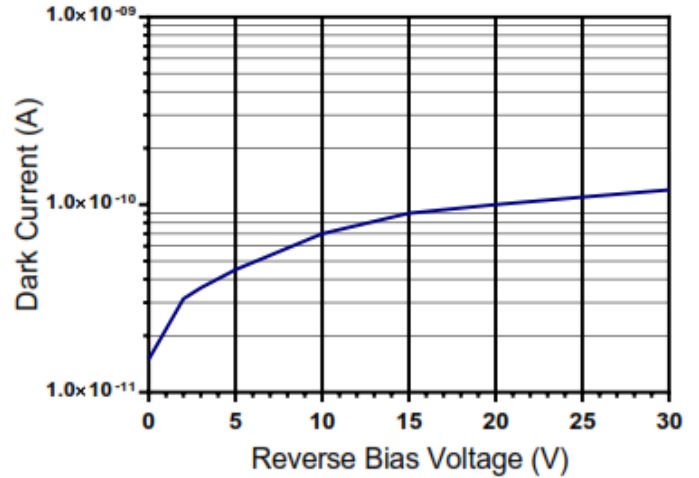

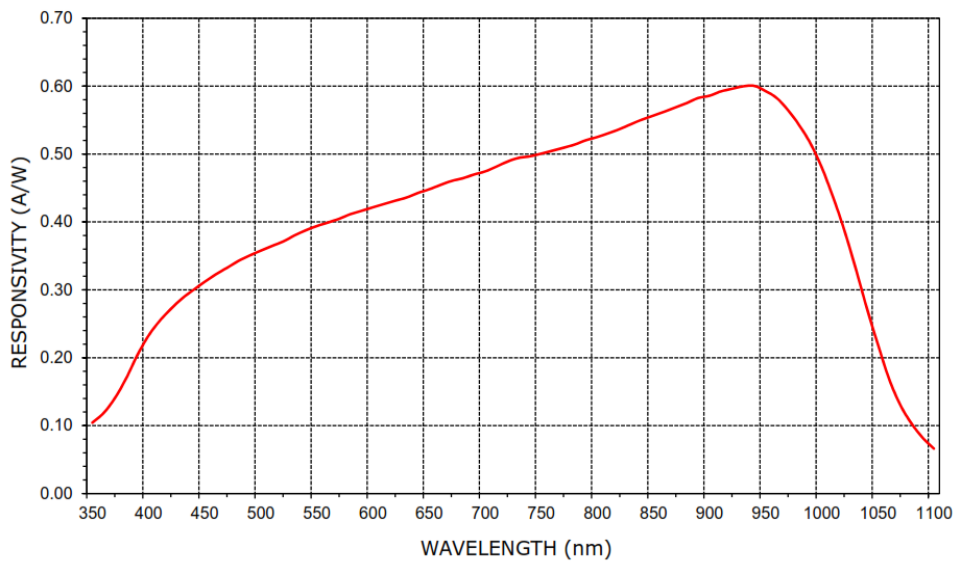
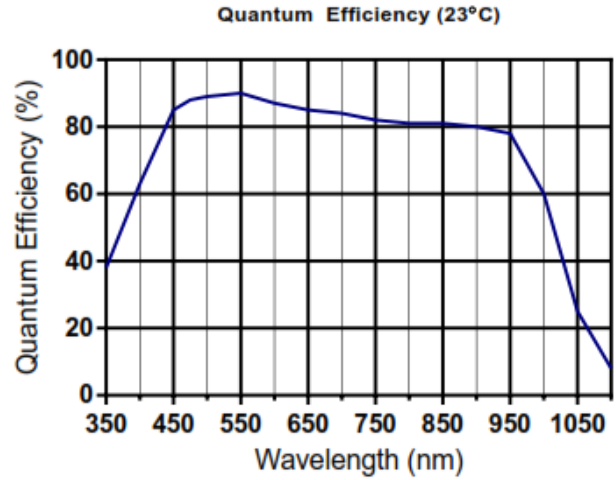
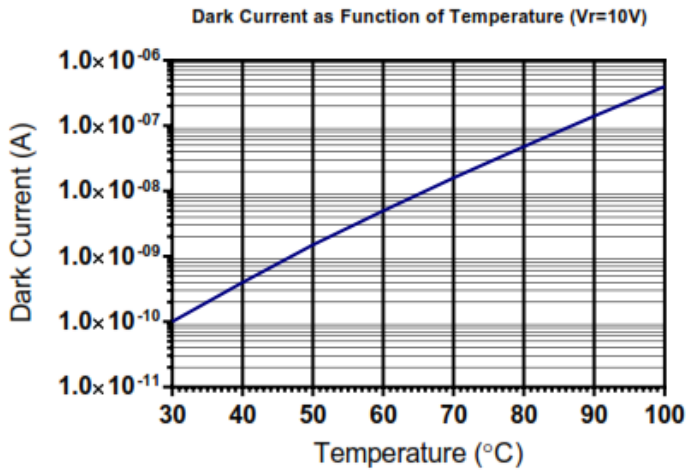

The information contained herein is subject to change without notice.

2016-04-29