



# RF Power Field Effect Transistors

## N-Channel Enhancement-Mode Lateral MOSFETs

Designed for W-CDMA and LTE base station applications with frequencies from 2300 to 2620 MHz. Can be used in Class AB and Class C for all typical cellular base station modulation formats.

- Typical Doherty Single-Carrier W-CDMA Performance:  $V_{DD} = 28$  Volts,  $I_{DQA} = 280$  mA,  $V_{GSB} = 0.7$  Vdc,  $P_{out} = 16$  Watts Avg., IQ Magnitude Clipping, Channel Bandwidth = 3.84 MHz, Input Signal PAR = 7.5 dB @ 0.01% Probability on CCDF.

Frequency	$G_{ps}$ (dB)	$\eta_D$ (%)	Output PAR (dB)	ACPR (dBc)
2300 MHz	14.6	42.0	6.7	-29.5
2350 MHz	14.7	41.6	6.8	-31.5
2400 MHz	14.6	41.4	6.6	-32.5

- Capable of Handling 10:1 VSWR, @ 32 Vdc, 2350 MHz, 90 Watts CW Output Power (3 dB Input Overdrive from Rated  $P_{out}$ )
- Typical  $P_{out}$  @ 3 dB Compression Point  $\approx$  100 Watts CW

### Features

- Production Tested in a Symmetrical Doherty Configuration
- 100% PAR Tested for Guaranteed Output Power Capability
- Characterized with Large-Signal Load-Pull Parameters and Common Source S-Parameters
- Internally Matched for Ease of Use
- Integrated ESD Protection
- Greater Negative Gate-Source Voltage Range for Improved Class C Operation
- Designed for Digital Predistortion Error Correction Systems
- RoHS Compliant
- NI-780-4 in Tape and Reel. R3 Suffix = 250 Units, 56 mm Tape Width, 13 inch Reel.
- NI-780S-4 in Tape and Reel. R3 Suffix = 250 Units, 32 mm Tape Width, 13 inch Reel.

**MRF8P23080HR3**  
**MRF8P23080HSR3**

**2300-2400 MHz, 16 W AVG., 28 V**  
**W-CDMA, LTE**  
**LATERAL N-CHANNEL**  
**RF POWER MOSFETs**

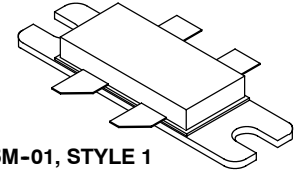

**CASE 465M-01, STYLE 1**  
**NI-780-4**  
**MRF8P23080HR3**

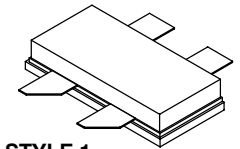

**CASE 465H-02, STYLE 1**  
**NI-780S-4**  
**MRF8P23080HSR3**

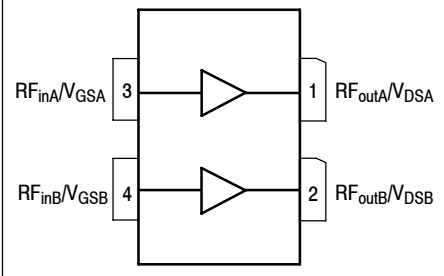

(Top View)

**Figure 1. Pin Connections**

**Table 1. Maximum Ratings**

Rating	Symbol	Value	Unit
Drain-Source Voltage	$V_{DSS}$	-0.5, +65	Vdc
Gate-Source Voltage	$V_{GS}$	-6.0, +10	Vdc
Operating Voltage	$V_{DD}$	32, +0	Vdc
Storage Temperature Range	$T_{stg}$	-65 to +150	$^{\circ}C$
Case Operating Temperature	$T_C$	150	$^{\circ}C$
Operating Junction Temperature (1,2)	$T_J$	225	$^{\circ}C$
CW Operation @ $T_C = 25^{\circ}C$ Derate above $25^{\circ}C$	CW	168 2.39	W W/ $^{\circ}C$

1. Continuous use at maximum temperature will affect MTTF.
2. MTTF calculator available at <http://www.freescale.com/rf>. Select Software & Tools/Development Tools/Calculators to access MTTF calculators by product.

**Table 2. Thermal Characteristics**

Characteristic	Symbol	Value (1,2)	Unit
Thermal Resistance, Junction to Case Case Temperature 72°C, 16 W CW, 28 Vdc, I <sub>DQA</sub> = 280 mA, V <sub>G<sub>SB</sub></sub> = 0.7 V, 2300 MHz Case Temperature 80°C, 80 W CW <sup>(3)</sup> , 28 Vdc, I <sub>DQA</sub> = 280 mA, V <sub>G<sub>SB</sub></sub> = 0.7 V, 2300 MHz	R <sub>θJC</sub>	0.89 0.55	°C/W

**Table 3. ESD Protection Characteristics**

Test Methodology	Class
Human Body Model (per JESD22-A114)	2 (Minimum)
Machine Model (per EIA/JESD22-A115)	A (Minimum)
Charge Device Model (per JESD22-C101)	IV (Minimum)

**Table 4. Electrical Characteristics** (T<sub>A</sub> = 25°C unless otherwise noted)

Characteristic	Symbol	Min	Typ	Max	Unit
----------------	--------	-----	-----	-----	------

**Off Characteristics (4)**

Zero Gate Voltage Drain Leakage Current (V <sub>DS</sub> = 65 Vdc, V <sub>GS</sub> = 0 Vdc)	I <sub>DSS</sub>	—	—	10	μAdc
Zero Gate Voltage Drain Leakage Current (V <sub>DS</sub> = 28 Vdc, V <sub>GS</sub> = 0 Vdc)	I <sub>DSS</sub>	—	—	1	μAdc
Gate-Source Leakage Current (V <sub>GS</sub> = 5 Vdc, V <sub>DS</sub> = 0 Vdc)	I <sub>GSS</sub>	—	—	1	μAdc

**On Characteristics (4)**

Gate Threshold Voltage (V <sub>DS</sub> = 10 Vdc, I <sub>D</sub> = 75 μAdc)	V <sub>GS(th)</sub>	1.0	1.8	2.5	Vdc
Gate Quiescent Voltage (V <sub>DD</sub> = 28 Vdc, I <sub>DA</sub> = 280 mAdc, Measured in Functional Test)	V <sub>GS(Q)</sub>	1.9	2.6	3.4	Vdc
Drain-Source On-Voltage (V <sub>GS</sub> = 10 Vdc, I <sub>D</sub> = 0.75 Adc)	V <sub>DS(on)</sub>	0.1	0.23	0.3	Vdc

**Functional Tests (5,6)** (In Freescale Doherty Test Fixture, 50 ohm system) V<sub>DD</sub> = 28 Vdc, I<sub>DQA</sub> = 280 mA, V<sub>G<sub>SB</sub></sub> = 0.7 Vdc, P<sub>out</sub> = 16 W Avg., f = 2300 MHz, Single-Carrier W-CDMA, IQ Magnitude Clipping, Input Signal PAR = 7.5 dB @ 0.01% Probability on CCDF. ACPR measured on 3.84 MHz Channel Bandwidth @ ±5 MHz Offset.

Power Gain	G <sub>ps</sub>	13.5	14.6	18.5	dB
Drain Efficiency	η <sub>D</sub>	38.0	42.0	—	%
Output Peak-to-Average Ratio @ 0.01% Probability on CCDF	PAR	6.0	6.7	—	dB
Adjacent Channel Power Ratio	ACPR	—	-29.5	-27.0	dBc

**Typical Broadband Performance (6)** (In Freescale Doherty Test Fixture, 50 ohm system) V<sub>DD</sub> = 28 Vdc, I<sub>DQA</sub> = 280 mA, V<sub>G<sub>SB</sub></sub> = 0.7 Vdc, P<sub>out</sub> = 16 W Avg., Single-Carrier W-CDMA, IQ Magnitude Clipping, Input Signal PAR = 7.5 dB @ 0.01% Probability on CCDF. ACPR measured in 3.84 MHz Channel Bandwidth @ ±5 MHz Offset.

Frequency	G <sub>ps</sub> (dB)	η <sub>D</sub> (%)	Output PAR (dB)	ACPR (dBc)
2300 MHz	14.6	42.0	6.7	-29.5
2350 MHz	14.7	41.6	6.8	-31.5
2400 MHz	14.6	41.4	6.6	-32.5

1. MTTF calculator available at <http://www.freescale.com/rf>. Select Software & Tools/Development Tools/Calculators to access MTTF calculators by product.
2. Refer to AN1955, *Thermal Measurement Methodology of RF Power Amplifiers*. Go to <http://www.freescale.com/rf>. Select Documentation/Application Notes - AN1955.
3. Exceeds recommended operating conditions. See CW operation data in Maximum Ratings table.
4. Each side of device measured separately.
5. Part internally matched both on input and output.
6. Measurement made with device in a Symmetrical Doherty configuration

(continued)

**Table 4. Electrical Characteristics** ( $T_A = 25^\circ\text{C}$  unless otherwise noted) (continued)

Characteristic	Symbol	Min	Typ	Max	Unit
<b>Typical Performances</b> <sup>(1)</sup> (In Freescale Doherty Test Fixture, 50 ohm system) $V_{DD} = 28\text{ Vdc}$ , $I_{DQA} = 280\text{ mA}$ , $V_{GSB} = 0.7\text{ Vdc}$ , 2300–2400 MHz Bandwidth					
$P_{out}$ @ 1 dB Compression Point, CW	P1dB	—	55	—	W
$P_{out}$ @ 3 dB Compression Point, CW	P3dB	—	100	—	W
IMD Symmetry @ 20 W PEP, $P_{out}$ where IMD Third Order Intermodulation $\cong 30\text{ dBc}$ (Delta IMD Third Order Intermodulation between Upper and Lower Sidebands > 2 dB)	IMD <sub>sym</sub>	—	30	—	MHz
VBW Resonance Point (IMD Third Order Intermodulation Inflection Point)	VBW <sub>res</sub>	—	55	—	MHz
Gain Flatness in 100 MHz Bandwidth @ $P_{out} = 16\text{ W Avg.}$	$G_F$	—	0.1	—	dB
Gain Variation over Temperature ( $-30^\circ\text{C}$ to $+85^\circ\text{C}$ )	$\Delta G$	—	0.013	—	dB/ $^\circ\text{C}$
Output Power Variation over Temperature ( $-30^\circ\text{C}$ to $+85^\circ\text{C}$ ) <sup>(2)</sup>	$\Delta P_{1dB}$	—	0.005	—	dB/ $^\circ\text{C}$

1. Measurement made with device in a Symmetrical Doherty configuration.
2. Exceeds recommended operating conditions. See CW operation data in Maximum Ratings table.

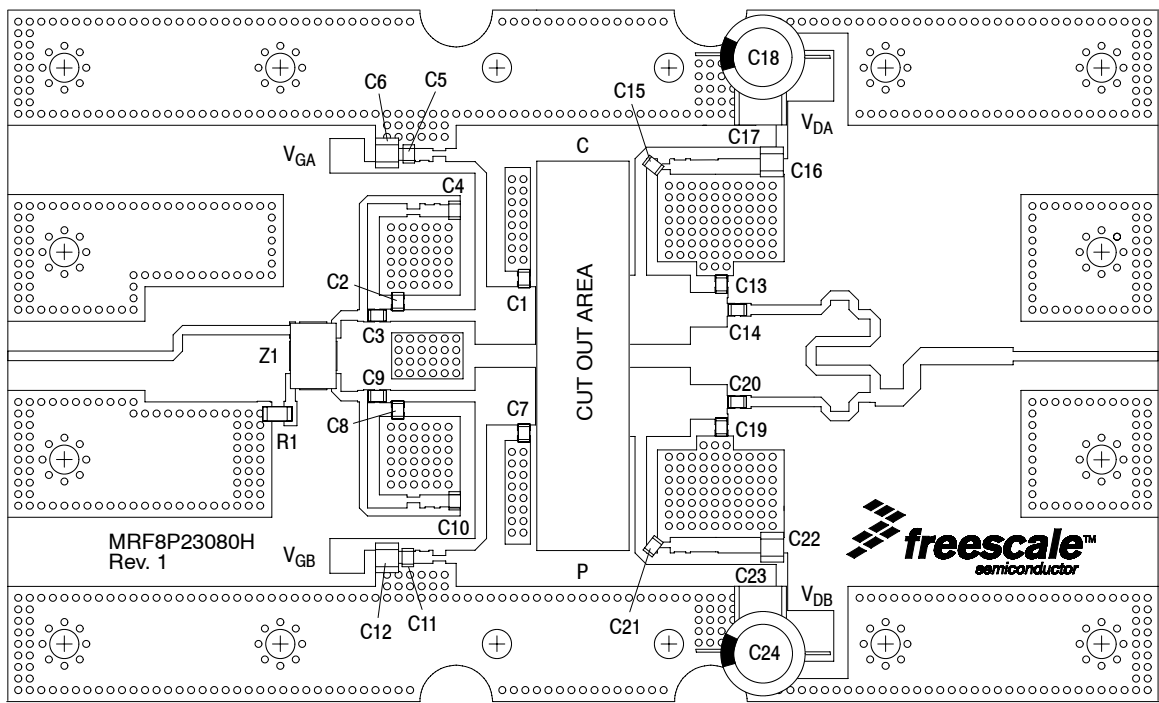
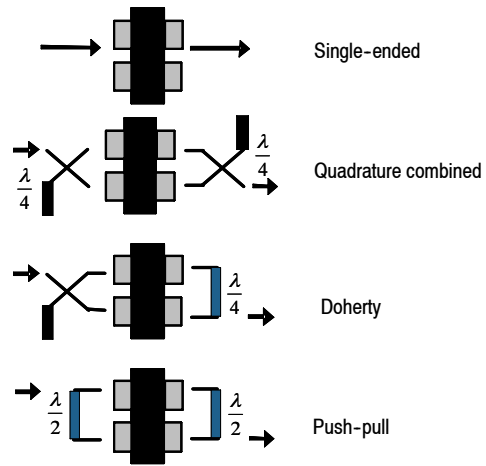

Figure 2. MRF8P23080HR3(HSR3) Test Circuit Component Layout

Table 5. MRF8P23080HR3(HSR3) Test Circuit Component Designations and Values

Part	Description	Part Number	Manufacturer
C1, C7	0.8 pF Chip Capacitors	ATC600F0R8JT250XT	ATC
C2, C8, C13, C19	1.0 pF Chip Capacitors	ATC600F1R0JT250XT	ATC
C3, C9	18 pF Chip Capacitors	ATC600F180JT250XT	ATC
C4, C5, C10, C11	8.2 pF Chip Capacitors	ATC600F8R2JT250XT	ATC
C6, C12, C16, C22	1.0 $\mu$ F, 50 V Chip Capacitors	GRM21BR71H105KA12L	Murata
C14, C20	10 pF Chip Capacitors	ATC600F100JT250XT	ATC
C15, C21	5.6 pF Chip Capacitors	ATC600F5R6JT250XT	ATC
C17, C23	10 $\mu$ F, 50 V Chip Capacitors	GRM55DR61H106KA88L	Murata
C18, C24	470 $\mu$ F, 63 V Electrolytic Capacitors	MCGPR63V477M13X26-RH	Multicomp
R1	50 $\Omega$ , 1/4 W Chip Resistor	CRCW120650R0FKEA	Vishay
Z1	2500 MHz Band 90°, 3 dB Chip Hybrid Coupler	GSC356-HYB2500	Soshin
PCB	0.020", $\epsilon_r = 3.5$	RO4350B	Rogers



**Figure 3. Possible Circuit Topologies**

### TYPICAL CHARACTERISTICS

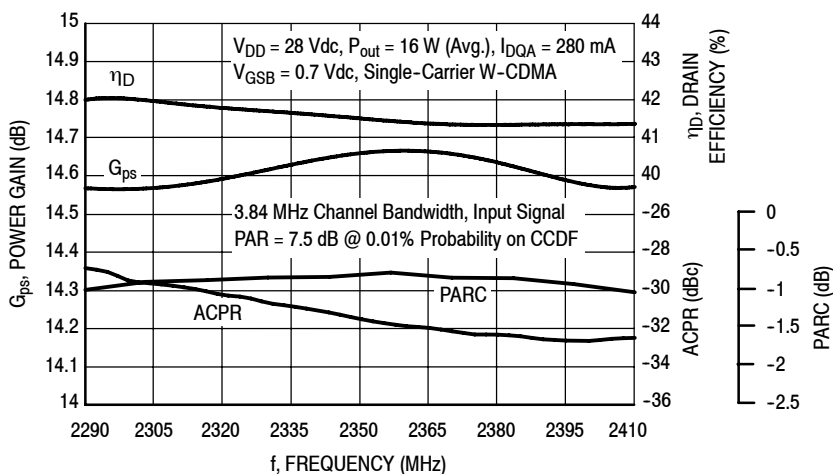

Figure 4. Output Peak-to-Average Ratio Compression (PARC) Broadband Performance @  $P_{out} = 16$  Watts Avg.

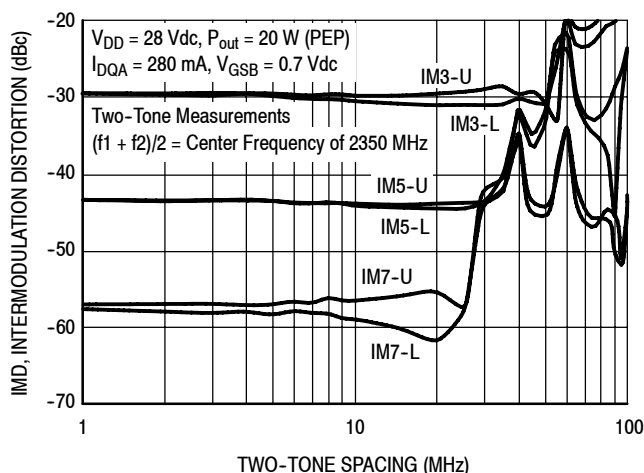

Figure 5. Intermodulation Distortion Products versus Two-Tone Spacing

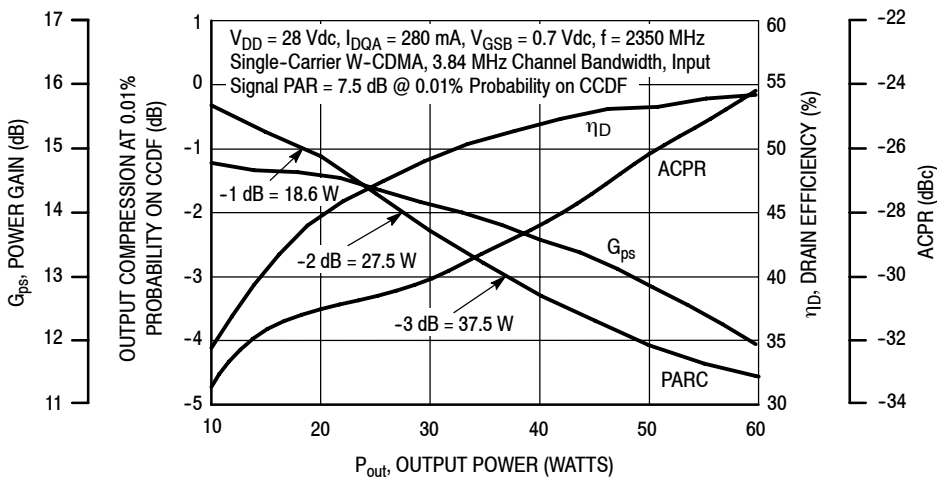

Figure 6. Output Peak-to-Average Ratio Compression (PARC) versus Output Power

## TYPICAL CHARACTERISTICS

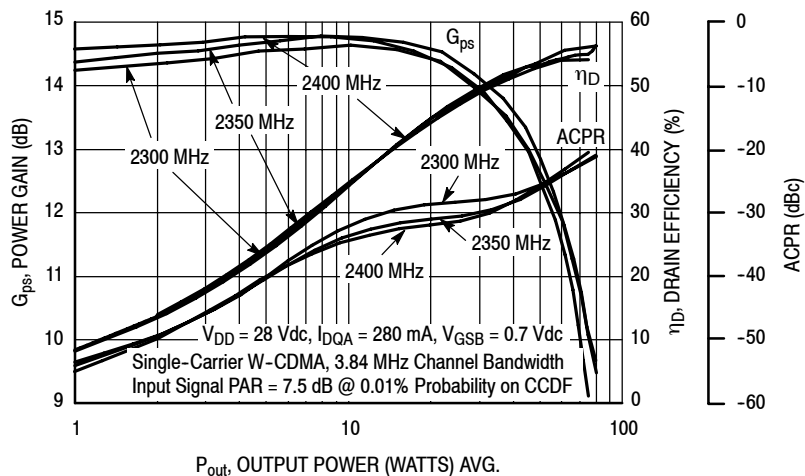

Figure 7. Single-Carrier W-CDMA Power Gain, Drain Efficiency and ACPR versus Output Power

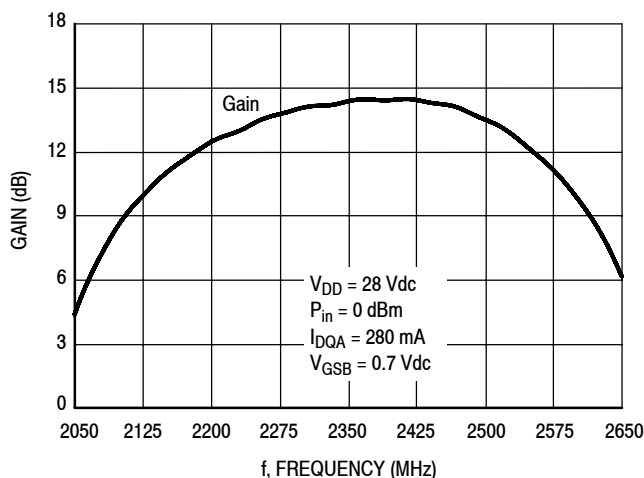

Figure 8. Broadband Frequency Response

## W-CDMA TEST SIGNAL

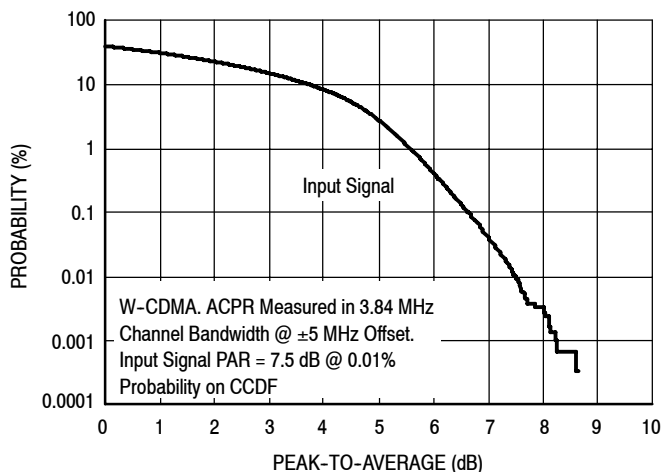

Figure 9. CCDF W-CDMA IQ Magnitude Clipping, Single-Carrier Test Signal

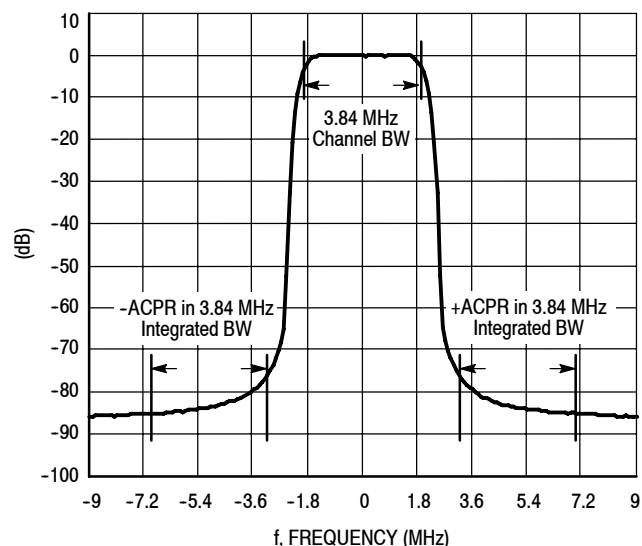

Figure 10. Single-Carrier W-CDMA Spectrum

MRF8P23080HR3 MRF8P23080HSR3

$V_{DD} = 28 \text{ Vdc}$ ,  $I_{DQA} = 280 \text{ mA}$

f MHz	Max $P_{out}$ (1)		$Z_{source}$ $\Omega$	$Z_{load}$ $\Omega$
	Watts	dBm		
2300	58	47.6	8.42 - j14.3	3.51 - j5.02
2350	55	47.4	11.4 - j13.4	3.75 - j5.03
2400	55	47.4	17.7 - j9.34	3.14 - j5.63

(1) Maximum output power measurement reflects pulsed 1 dB gain compression.

$Z_{source}$  = Test circuit impedance as measured from gate contact to ground.

$Z_{load}$  = Test circuit impedance as measured from drain contact to ground.

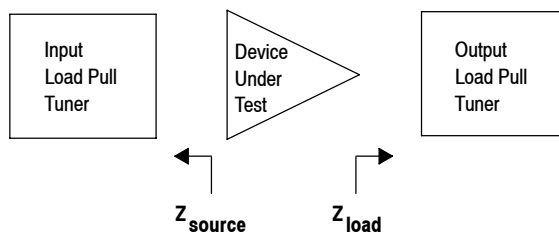

Figure 11. Carrier Side Load Pull Performance — Maximum P1dB Tuning

$V_{DD} = 28 \text{ Vdc}$ ,  $I_{DQA} = 280 \text{ mA}$

f MHz	Max Eff. (1) %	$Z_{source}$ $\Omega$	$Z_{load}$ $\Omega$
2300	60.9	8.41 - j14.3	7.02 - j3.44
2350	60.1	11.4 - j13.4	6.84 - j2.41
2400	60.0	17.7 - j9.35	6.53 - j2.92

(1) Maximum efficiency measurement reflects pulsed 1 dB gain compression.

$Z_{source}$  = Test circuit impedance as measured from gate contact to ground.

$Z_{load}$  = Test circuit impedance as measured from drain contact to ground.

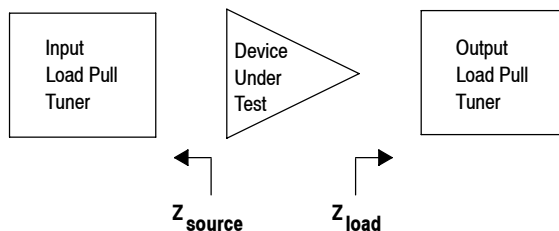
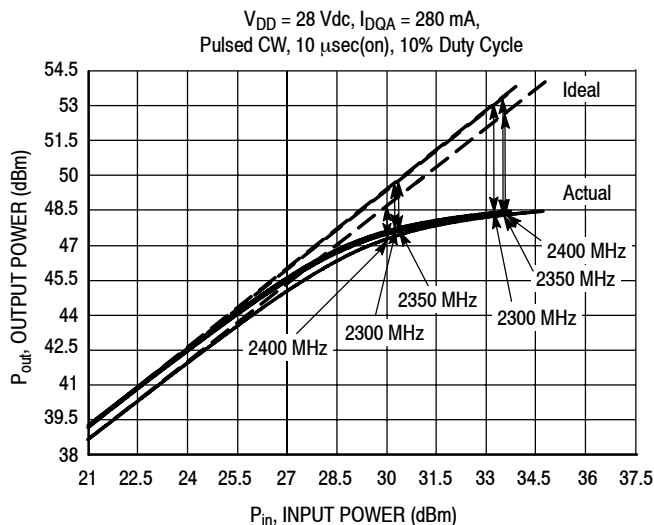

Figure 12. Carrier Side Load Pull Performance — Maximum Efficiency Tuning



## ALTERNATIVE PEAK TUNE LOAD PULL CHARACTERISTICS



NOTE: Load Pull Test Fixture Tuned for Peak P1dB Output Power @ 28 V

f (MHz)	P1dB		P3dB	
	Watts	dBm	Watts	dBm
2300	59	47.7	69	48.4
2350	58	47.6	68	48.3
2400	54	47.3	68	48.3

Test Impedances per Compression Level

f (MHz)		$Z_{source}$ $\Omega$	$Z_{load}$ $\Omega$
2300	P1dB	8.40 - j14.3	3.60 - j5.30
2350	P1dB	11.4 - j13.4	3.70 - j5.20
2400	P1dB	17.7 - j9.30	3.10 - j5.10

**Figure 11. Pulsed CW Output Power versus Input Power @ 28 V**

NOTE: Measurement made on the Class AB, carrier side of the device.

### PACKAGE DIMENSIONS

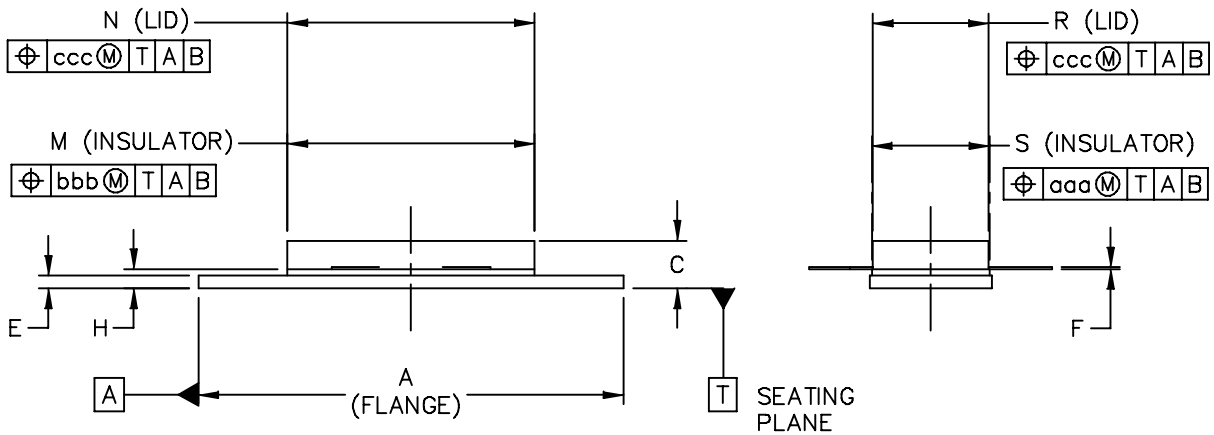
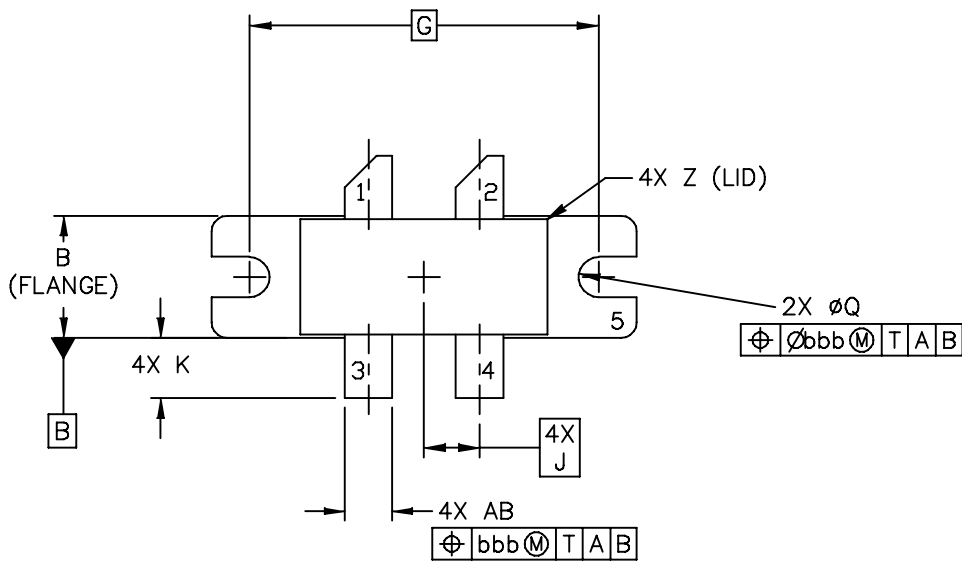

© FREESCALE SEMICONDUCTOR, INC. ALL RIGHTS RESERVED.	MECHANICAL OUTLINE	PRINT VERSION NOT TO SCALE
TITLE:  NI 780-4	DOCUMENT NO: 98ASA10793D	REV: 0
	CASE NUMBER: 465M-01	27 MAR 2007
	STANDARD: NON-JEDEC	

NOTES:

1. DIMENSIONING AND TOLERANCING PER ANSI Y14.5M-1994.
2. CONTROLLING DIMENSION: INCH.
3. DIMENSION H IS MEASURED .030 (0.762) AWAY FROM PACKAGE BODY.

STYLE 1:

- PIN 1. DRAIN  
 2. DRAIN  
 3. GATE  
 4. GATE  
 5. SOURCE

DIM	INCH		MILLIMETER		DIM	INCH		MILLIMETER	
	MIN	MAX	MIN	MAX		MIN	MAX	MIN	MAX
A	1.335	1.345	33.91	34.16	R	.365	.375	9.27	9.53
B	.380	.390	9.65	9.91	S	.365	.375	9.27	9.52
C	.125	.170	3.18	4.32	U		.040		1.02
E	.035	.045	0.89	1.14	Z		.030		0.76
F	.003	.006	0.08	0.15	AB	.145	.155	3.68	3.94
G	1.100 BSC		27.94 BSC						
H	.057	.067	1.45	1.7	aaa		.005		0.127
J	.175 BSC		4.44 BSC		bbb		.010		0.254
K	.170	.210	4.32	5.33	ccc		.015		0.381
M	.774	.786	19.61	20.02					
N	.772	.788	19.61	20.02					
Q	Ø.118	Ø.138	Ø3	Ø3.51					
© FREESCALE SEMICONDUCTOR, INC. ALL RIGHTS RESERVED.			MECHANICAL OUTLINE			PRINT VERSION NOT TO SCALE			
TITLE:  NI 780-4					DOCUMENT NO: 98ASA10793D			REV: 0	
					CASE NUMBER: 465M-01			27 MAR 2007	
					STANDARD: NON-JEDEC				

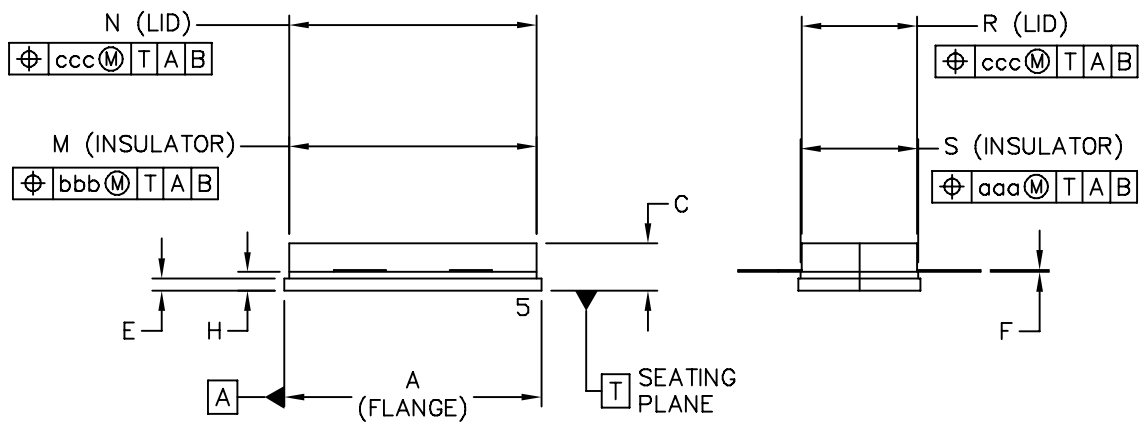
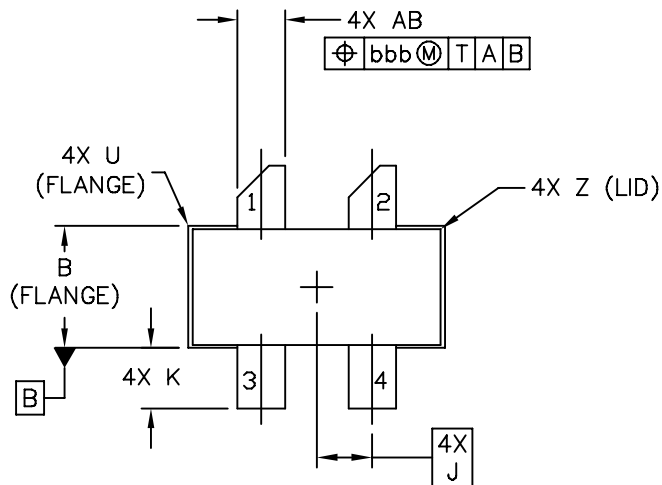

© FREESCALE SEMICONDUCTOR, INC. ALL RIGHTS RESERVED.	<b>MECHANICAL OUTLINE</b>	PRINT VERSION NOT TO SCALE	
TITLE:  NI 780S-4	DOCUMENT NO: 98ASA10718D	REV: A	
	CASE NUMBER: 465H-02	27 MAR 2007	
	STANDARD: NON-JEDEC		

NOTES:

1. DIMENSIONING AND TOLERANCING PER ANSI Y14.5M-1994.
2. CONTROLLING DIMENSION: INCH.
3. DELETED
4. DIMENSION H IS MEASURED .030 (0.762) AWAY FROM PACKAGE BODY.

STYLE 1:

- PIN 1. DRAIN
2. DRAIN
3. GATE
4. GATE
5. SOURCE

DIM	INCH		MILLIMETER		DIM	INCH		MILLIMETER	
	MIN	MAX	MIN	MAX		MIN	MAX	MIN	MAX
A	.805	.815	20.45	20.7	U		.040		1.02
B	.380	.390	9.65	9.91	Z		.030		0.76
C	.125	.170	3.18	4.32	AB	.145	.155	3.68	– 3.94
E	.035	.045	0.89	1.14					
F	.003	.006	0.08	0.15	aaa		.005		0.127
H	.057	.067	1.45	1.7	bbb		.010		0.254
J	.175 BSC		4.44 BSC		ccc		.015		0.381
K	.170	.210	4.32	5.33					
M	.774	.786	19.61	20.02					
N	.772	.788	19.61	20.02					
R	.365	.375	9.27	9.53					
S	.365	.375	9.27	9.52					
© FREESCALE SEMICONDUCTOR, INC. ALL RIGHTS RESERVED.			<b>MECHANICAL OUTLINE</b>			PRINT VERSION NOT TO SCALE			
TITLE:  NI 780S-4					DOCUMENT NO: 98ASA10718D			REV: A	
					CASE NUMBER: 465H-02			27 MAR 2007	
					STANDARD: NON-JEDEC				

## PRODUCT DOCUMENTATION AND SOFTWARE

Refer to the following documents and software to aid your design process.

### Application Notes

- AN1955: Thermal Measurement Methodology of RF Power Amplifiers

### Engineering Bulletins

- EB212: Using Data Sheet Impedances for RF LDMOS Devices

### Software

- Electromigration MTTF Calculator
- RF High Power Model
- .s2p File

For Software, do a Part Number search at <http://www.freescale.com>, and select the “Part Number” link. Go to the Software & Tools tab on the part’s Product Summary page to download the respective tool.

## REVISION HISTORY

The following table summarizes revisions to this document.

Revision	Date	Description
0	May 2010	<ul style="list-style-type: none"><li>• Initial Release of Data Sheet</li></ul>
1	Nov. 2010	<ul style="list-style-type: none"><li>• Updated frequency in overview paragraph from “2300 to 2400 MHz” to “2300 to 2620 MHz” to show the broadband performance of the part, p. 1</li><li>• In Table 2, Thermal Characteristics, <math>P_{out} = 16</math> W CW thermal resistance value changed from 0.91 to 0.89°C/W and <math>P_{out} = 80</math> W CW thermal resistance value changed from 0.91 to 0.55°C/W. Thermal values now reflect the use of the combined dissipated power from the carrier amplifier and peaking amplifier, p. 2.</li><li>• Broadband IRL data removed from Fig. 4, Output Peak-to-Average Ratio Compression (PARC) Broadband Performance and Fig. 8, Broadband Frequency Response graphs. Data not valid indicator of product performance due to circuit implementation, p. 6, 7.</li></ul>

## ***How to Reach Us:***

### **Home Page:**

[www.freescale.com](http://www.freescale.com)

### **Web Support:**

<http://www.freescale.com/support>

### **USA/Europe or Locations Not Listed:**

Freescale Semiconductor, Inc.  
Technical Information Center, EL516  
2100 East Elliot Road  
Tempe, Arizona 85284  
1-800-521-6274 or +1-480-768-2130  
[www.freescale.com/support](http://www.freescale.com/support)

### **Europe, Middle East, and Africa:**

Freescale Halbleiter Deutschland GmbH  
Technical Information Center  
Schatzbogen 7  
81829 Muenchen, Germany  
+44 1296 380 456 (English)  
+46 8 52200080 (English)  
+49 89 92103 559 (German)  
+33 1 69 35 48 48 (French)  
[www.freescale.com/support](http://www.freescale.com/support)

### **Japan:**

Freescale Semiconductor Japan Ltd.  
Headquarters  
ARCO Tower 15F  
1-8-1, Shimo-Meguro, Meguro-ku,  
Tokyo 153-0064  
Japan  
0120 191014 or +81 3 5437 9125  
[support.japan@freescale.com](mailto:support.japan@freescale.com)

### **Asia/Pacific:**

Freescale Semiconductor China Ltd.  
Exchange Building 23F  
No. 118 Jianguo Road  
Chaoyang District  
Beijing 100022  
China  
+86 10 5879 8000  
[support.asia@freescale.com](mailto:support.asia@freescale.com)

### **For Literature Requests Only:**

Freescale Semiconductor Literature Distribution Center  
1-800-441-2447 or +1-303-675-2140  
Fax: +1-303-675-2150  
[LDCForFreescaleSemiconductor@hibbertgroup.com](mailto:LDCForFreescaleSemiconductor@hibbertgroup.com)

Information in this document is provided solely to enable system and software implementers to use Freescale Semiconductor products. There are no express or implied copyright licenses granted hereunder to design or fabricate any integrated circuits or integrated circuits based on the information in this document.

Freescale Semiconductor reserves the right to make changes without further notice to any products herein. Freescale Semiconductor makes no warranty, representation or guarantee regarding the suitability of its products for any particular purpose, nor does Freescale Semiconductor assume any liability arising out of the application or use of any product or circuit, and specifically disclaims any and all liability, including without limitation consequential or incidental damages. "Typical" parameters that may be provided in Freescale Semiconductor data sheets and/or specifications can and do vary in different applications and actual performance may vary over time. All operating parameters, including "Typicals", must be validated for each customer application by customer's technical experts. Freescale Semiconductor does not convey any license under its patent rights nor the rights of others. Freescale Semiconductor products are not designed, intended, or authorized for use as components in systems intended for surgical implant into the body, or other applications intended to support or sustain life, or for any other application in which the failure of the Freescale Semiconductor product could create a situation where personal injury or death may occur. Should Buyer purchase or use Freescale Semiconductor products for any such unintended or unauthorized application, Buyer shall indemnify and hold Freescale Semiconductor and its officers, employees, subsidiaries, affiliates, and distributors harmless against all claims, costs, damages, and expenses, and reasonable attorney fees arising out of, directly or indirectly, any claim of personal injury or death associated with such unintended or unauthorized use, even if such claim alleges that Freescale Semiconductor was negligent regarding the design or manufacture of the part.

Freescale™ and the Freescale logo are trademarks of Freescale Semiconductor, Inc. All other product or service names are the property of their respective owners.

© Freescale Semiconductor, Inc. 2010. All rights reserved.

