

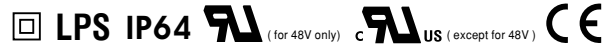

■ Features :

- Universal AC input / Full range
- Protections: Short circuit / Over current / Over voltage
- Cooling by free air convection
- Built-in constant current limiting circuit with adjustable OCP level
- Optional dimming function : 1.1~10VDC (D type) or PWM (P type) controlled
- Fully isolated plastic case with IP64 level
- Class II power unit, no FG
- Class 2 power unit
- Pass LPS
- Suitable for LED lighting and moving sign applications (Note.8)
- 100% full load burn-in test
- Low cost
- 2 years warranty

SPECIFICATION



MODEL		ELN-30-5	ELN-30-9	ELN-30-12	ELN-30-15	ELN-30-24	ELN-30-27	ELN-30-48	
OUTPUT	DC VOLTAGE	5V	9V	12V	15V	24V	27V	48V	
	LED OPERATION VOLTAGE Note.7	3 ~ 5V	3 ~ 9V	3 ~ 12V	3 ~ 15V	3 ~ 24V	3 ~ 27V	3 ~ 48V	
	RATED CURRENT	5A	3.4A	2.5A	2A	1.25A	1.12A	0.63A	
	CURRENT RANGE	0 ~ 5A	0 ~ 3.4A	0 ~ 2.5A	0 ~ 2A	0 ~ 1.25A	0 ~ 1.12A	0 ~ 0.63A	
	RATED POWER	25W	30.6W	30W	30W	30W	30.24W	30.24W	
	RIPPLE & NOISE (max.) Note.2	80mVp-p	100mVp-p	120mVp-p	120mVp-p	150mVp-p	150mVp-p	250mVp-p	
	VOLTAGE ADJ. RANGE	4.5 ~ 5.5V	8.7 ~ 10.5V	10.8 ~ 13.2V	13.5 ~ 16.5V	21.6 ~ 26.4V	24.3 ~ 29.7V	43.2 ~ 52.8V	
	CURRENT ADJ. RANGE	Can be adjusted by internal potentiometer SVR1							
	VOLTAGE TOLERANCE Note.3	±5.0%							
	LINE REGULATION	±1.0%							
	LOAD REGULATION	±2.0%							
	INPUT	SETUP, RISE TIME Note.6	500ms, 80ms / 230VAC 1000ms, 80ms / 115VAC at full load						
HOLD UP TIME (Typ.)		50ms/230VAC 16ms/115VAC at full load							
VOLTAGE RANGE Note.4		90 ~ 264VAC 127 ~ 370VDC							
FREQUENCY RANGE		47 ~ 63Hz							
EFFICIENCY (Typ.)		75%	80%	82%	82%	85%	85%	87%	
AC CURRENT (Typ.)		0.75A/115VAC 0.48A/230VAC							
INRUSH CURRENT (Typ.)		COLD START 55A(twidth=465µs measured at 50% Ipeak) at 230VAC							
PROTECTION	MAX. No. of PSUs on 16A CIRCUIT BREAKER	4 units (circuit breaker of type B) / 8 units (circuit breaker of type C) at 230VAC							
	LEAKAGE CURRENT	0.25mA / 240VAC							
	OVER CURRENT	95 ~ 110% Protection type : Constant current limiting, recovers automatically after fault condition is removed							
FUNCTION	OVER VOLTAGE	5.75 ~ 6.75V	11 ~ 13.5V	13.8 ~ 16V	17.5 ~ 21V	28 ~ 32V	31 ~ 36.4V	54 ~ 60V	
	DIMMING CONTROL (OPTIONAL)	1.1 ~ 10VDC or PWM signal : 100Hz ~ 3KHz Protection type : Shut down o/p voltage, re-power on to recover							
ENVIRONMENT	WORKING TEMP.	-20 ~ +60°C (Refer to "Derating Curve")							
	WORKING HUMIDITY	20 ~ 90% RH non-condensing							
	STORAGE TEMP., HUMIDITY	-40 ~ +80°C, 10 ~ 95% RH							
	TEMP. COEFFICIENT	±0.03%/°C (0 ~ 50°C)							
	VIBRATION	10 ~ 500Hz, 2G 10min./1cycle, period for 60min. each along X, Y, Z axes							
SAFETY & EMC	SAFETY STANDARDS	UL1310, CAN/CSA C22.2 No. 223-M91(except for 48V), IP64 approved ; design refer to TUV EN60950-1							
	WITHSTAND VOLTAGE	I/P-O/P:3KVAC							
	ISOLATION RESISTANCE	I/P-O/P:>100M Ohms / 500VDC / 25°C/ 70% RH							
	EMC EMISSION	Compliance to EN55032 (CISPR32) Class B, EN61000-3-2 Class A, EN61000-3-3							
	EMC IMMUNITY	Compliance to EN61000-4-2,3,4,5,6,8,11, EN55024, light industry level, criteria A							
OTHERS	MTBF	628.3Khrs min. MIL-HDBK-217F (25°C)							
	DIMENSION	145*47*30mm (L*W*H)							
	PACKING	0.26Kg; 60pcs/16.6Kg/1.25CUFT							
NOTE	<ol style="list-style-type: none"> 1. All parameters NOT specially mentioned are measured at 230VAC input, rated load and 25°C of ambient temperature. 2. Ripple & noise are measured at 20MHz of bandwidth by using a 12" twisted pair-wire terminated with a 0.1uf & 47uf parallel capacitor. 3. Tolerance : includes set up tolerance, line regulation and load regulation. 4. Derating may be needed under low input voltage. Please check the static characteristics for more details. 5. The power supply is considered as a component that will be operated in combination with final equipment. Since EMC performance will be affected by the complete installation, the final equipment manufacturers must re-qualify EMC Directive on the complete installation again. 6. Length of set up time is measured at first cold start. Turning ON/OFF the power supply may lead to increase of the set up time. 7. Constant current operation region is within the specified output voltage range above. This is the suitable operation region for LED related applications. 8. The unit might not be suitable for lighting applications in EU countries. Please check with your local authorities for the possible use of the unit. 								

Mechanical Specification

Case No.964A Unit:mm

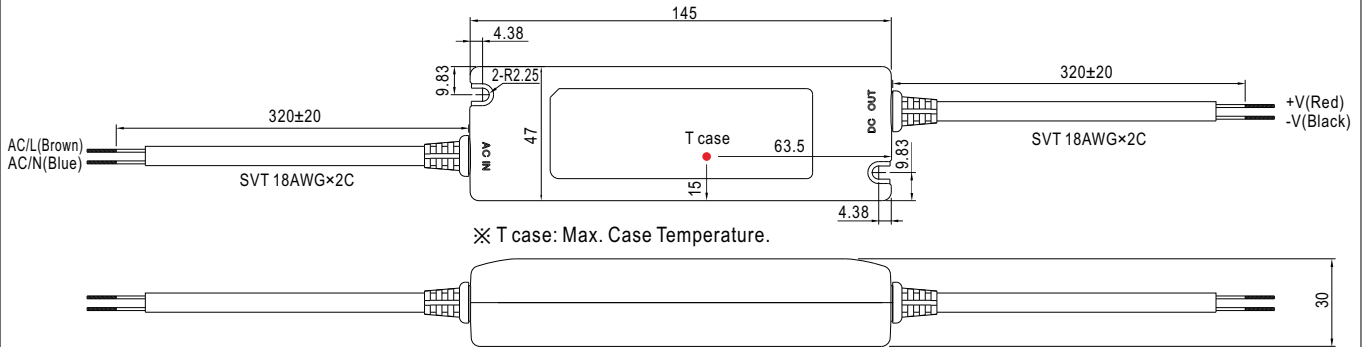

※ T case: Max. Case Temperature.

OUTPUT(with optional dimming function)

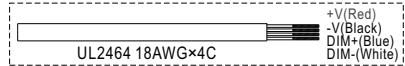

Output voltage and current adjustment : remove the upper case and adjust through SVR1 & SVR2 shown in the diagram.

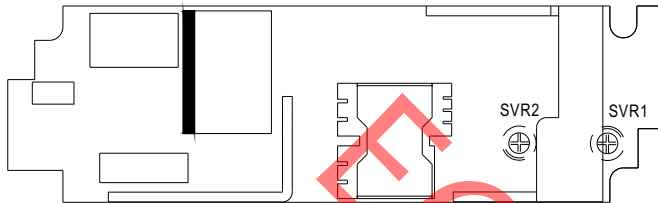

SVR1	Output voltage adjustment
SVR2	Output current adjustment

Block Diagram

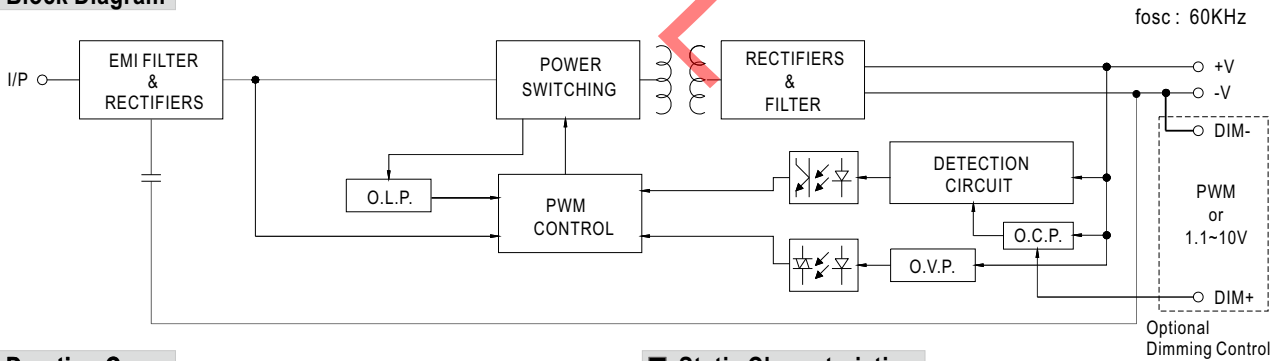

Derating Curve

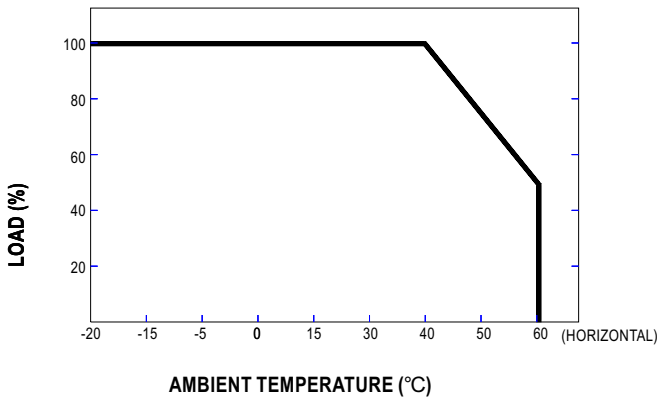

Static Characteristics

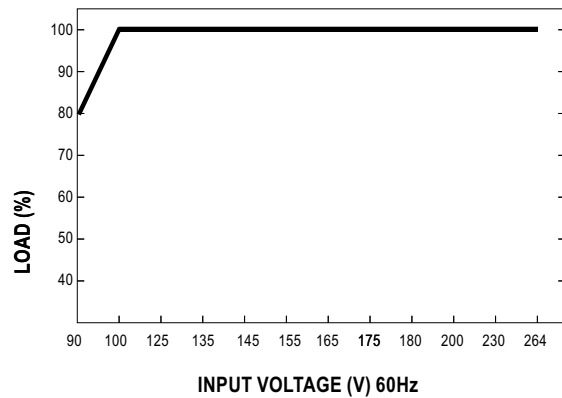

■ Dimming Control (Optional)

Level of output current can be adjusted through the dimming control function.

When there is no signal sending to the control wires (open circuit between the two control wires), the power supply unit will operate as 0V (D-type) or 0% duty (P-type) of input signal and hence the output current will be zero.

(1) 1.1~10V (D type, & : ELN-30-**12**D)

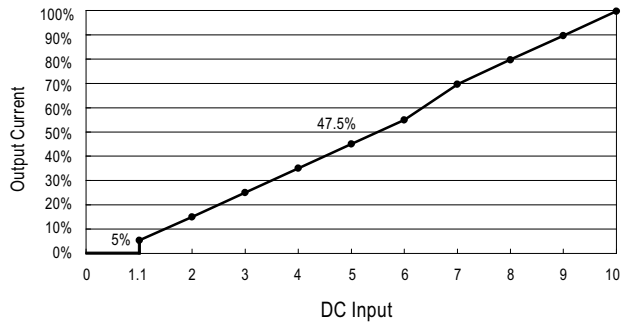
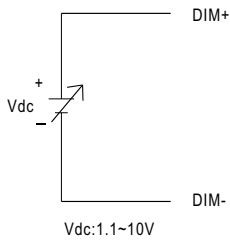

(2) PWM (P type, & : ELN-30-**12**P)

