



DS2411

Silicon Serial Number with or without V_{CC} Input

FEATURES

- Unique and Tested 64-Bit Registration Number (8-Bit Family Code Plus 48-Bit Serial Number Plus 8-Bit CRC Tester); Guaranteed No Two Parts Alike
- Standby Current <math><1\mu\text{A}</math>
- Built-In Multidrop Controller Enables Multiple DS2411s to Reside on a Common 1-Wire[®] Network
- Multidrop Compatible with Other 1-Wire Products
- 8-Bit Family Code Identifies Device as DS2411 to the 1-Wire Master
- Low-Cost TSOC, SOT23-3, and Flip-Chip Surface-Mount Packages
- Directly Connects to a Single-Port Pin of a Microprocessor and Communicates at up to 15.4kbps
- Overdrive Mode Boosts Communication Speed up to 125kbps
- DS2411 Operating Range: 1.5V to 5.25V (V_{CC})
- DS2411A Operating Range: 3V to 5.25V (no V_{CC}), from -40°C to +85°C

PIN DESCRIPTION

NAME	PIN		
	SOT23	TSOC	FLIP CHIP
I/O	1	2	A1
V _{CC} (DS2411) N.C. (DS2411A)*	2	6	B2
GND	3	1	B1
N.C.	—	3, 4, 5	A2

*No connection to die, so pin may be connected to V_{CC}.

DESCRIPTION

The DS2411 silicon serial number is a low-cost, electronic registration number with or without external power supply. It provides an absolutely unique identity that can be determined with a minimal electronic interface (typically, a single port pin of a microcontroller). The DS2411's registration number is a 64-bit unique ROM that includes a unique 48-bit serial number, an 8-bit CRC, and an 8-bit family code (01h). Data is transferred serially through the Analog Devices 1-Wire protocol. For the DS2411, an external power supply is required, extending the operating voltage range of the device below typical 1-Wire devices. The DS2411A does not require an external power supply and has a typical 1-Wire operating voltage range. However, it is functionally equivalent to the DS2411, but with differing electrical parameters.

PIN CONFIGURATION

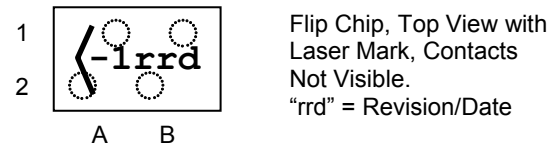
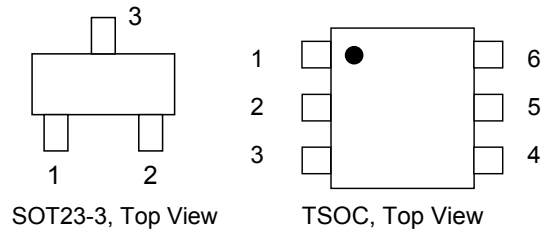

ORDERING INFORMATION

PART	TEMP RANGE	PIN-PACKAGE
DS2411R+T&R	-40°C to +85°C	3 SOT23-3
DS2411AR+T&R	-40°C to +85°C	3 SOT23-3
DS2411P+	-40°C to +85°C	6 TSOC
DS2411P+T&R	-40°C to +85°C	6 TSOC
DS2411X	-40°C to +85°C	4 Flip Chip*

+Denotes a lead(Pb)-free/RoHS-compliant package.
T&R = Tape and reel.

*The DS2411X is RoHS qualified and comes in tape and reel.

ABSOLUTE MAXIMUM RATINGS

I/O Voltage to GND	-0.5V to +6V
V _{CC} Voltage to GND (DS2411)	-0.5V to +6V
I/O V _{CC} Current (DS2411)	±20mA
I/O Sink Current (DS2411A)	±10mA
Operating Temperature Range	-40°C to +85°C
Junction Temperature	+150°C
Storage Temperature Range	-55°C to +125°C
Lead Temperature (TSOC, SOT23-3 only; soldering, 10s)	+300°C
Soldering Temperature (reflow)	
TSOC, SOT-23-3	+260°C
Flip Chip	+240°C

This is a stress rating only and functional operation of the device at these or any other conditions above those indicated in the operation sections of this specification is not implied. Exposure to absolute maximum rating conditions for extended periods of time may affect reliability.

ELECTRICAL CHARACTERISTICS

(T_A = -40°C to +85°C.)

PARAMETER	SYMBOL	DEVICE	CONDITIONS	MIN	TYP	MAX	UNITS
Supply Voltage	V _{CC}	DS2411	(Note 1)	1.5		5.25	V
Standby Supply Current	I _{CCS}		V(I/O) ≤ V _{IL} , or V(I/O) ≥ V _{IH}			1	μs
Active Supply Current	I _{CCA}					100	μs
I/O PIN GENERAL DATA							
1-Wire Pullup Voltage	V _{PUP}	DS2411	(Note 1) V _{CC} = V _{PUP}	1.5		5.25	V
		DS2411A	(Note 1)	3.0		5.25	
1-Wire Pullup Resistance	R _{PUP}	DS2411	(Notes 1, 2)	0.3		2.2	kΩ
		DS2411A	(Notes 1, 2)	0.3		2.2	
Power-Up Delay	t _{PWRP}	DS2411	V _{CC} stable to first 1-Wire command (Notes 1, 4)	1200			μs
Input Capacitance	C _{IO}	DS2411	(Note 4)			100	pF
		DS2411A	(Notes 4, 5)		1000		
Input Load Current	I _L	DS2411	0V ≤ V(I/O) ≤ V _{CC}	-1		+1	μA
		DS2411A	I/O pin at V _{PUP}	0.05	1.75	6.7	
High-to-Low Switching Threshold	V _{TL}	DS2411	(Notes 4, 10, 11)	0.4		3.2	V
		DS2411A	(Notes 4, 11, 18)		0.65 x V _{PUP}		
Input Low Voltage	V _{IL}	DS2411	(Note 1)			0.3	V
		DS2411A	(Notes 1, 6)			0.5	
Input High Voltage	V _{IH}	DS2411	(Note 1)	V _{CC} - 0.3			V
		DS2411A	(Notes 4, 10, 12)	0.75		3.4	
Low-to-High Switching Threshold	V _{TH}	DS2411	(Notes 4, 12, 18)		0.75 x V _{PUP}		V
		DS2411A	(Notes 4, 6)	0.18			
Switching Hysteresis	V _{HY}	DS2411	(Notes 4, 13, 18)		0.3		V
		DS2411A	(Note 14) I _{OL} = 4mA			0.4	
Output Low Voltage at 4mA	V _{OL}	DS2411	I _{OL} = 4mA			0.4	V
		DS2411A	I _{OL} = 4mA			0.4	
Rising Edge Holdoff (Notes 4, 15)	t _{REH}	DS2411	Standard speed	1.25		5	μs
		DS2411A	Standard speed		1.3		
		DS2411	Overdrive speed	0.5		2.0	
		DS2411A	Overdrive speed		N/A (0)		
Recovery Time	t _{REC}	DS2411	Standard speed, R _{PUP} = 2.2kΩ (Note 1)	5			μs
		DS2411A	Standard speed, R _{PUP} = 2.2kΩ (Notes 1, 3)	5			
		DS2411	Overdrive speed,	2			

PARAMETER	SYMBOL	DEVICE	CONDITIONS	MIN	TYP	MAX	UNITS
			$R_{PUP} = 2.2k\Omega$ (Note 1)				
		DS2411A	Overdrive speed, $R_{PUP} = 2.2k\Omega$ (Notes 1, 3)	3			
		DS2411	Overdrive speed, directly prior to reset pulse; $R_{PUP} = 2.2k\Omega$ (Note 1)	5			
		DS2411A	Overdrive speed, directly prior to reset pulse; $R_{PUP} = 2.2k\Omega$ (Notes 1, 3)	5			
Timeslot Duration (Notes 1, 19)	t_{SLOT}	DS2411	Standard speed	65			μs
		DS2411A	Standard speed	65			
		DS2411	Overdrive $V_{CC} \geq 2.2V$	8			
		DS2411	Overdrive $V_{CC} \geq 1.5V$	10			
		DS2411A	Overdrive speed	9			
I/O PIN, 1-Wire RESET, PRESENCE DETECT CYCLE							
Reset Low Time	t_{RSTL}	DS2411	Standard speed	480		640	μs
		DS2411A	Standard speed	480		640	
		DS2411	Overdrive speed	60		80	
		DS2411A	Overdrive speed	60		80	
Presence-Detect High Time	t_{PDH}	DS2411	Standard speed	15		60	μs
		DS2411A	Standard speed	15		60	
		DS2411	Overdrive $V_{CC} \geq 2.2V$	2		6	
		DS2411	Overdrive $V_{CC} \geq 1.5V$	2		8.5	
		DS2411A	Overdrive speed	2		6	
Presence-Detect Low Time	t_{PDL}	DS2411	Standard speed	60		240	μs
		DS2411A	Standard speed	60		240	
		DS2411	Overdrive $V_{CC} \geq 2.2V$	8		24	
		DS2411	Overdrive $V_{CC} \geq 1.5V$	8		30	
		DS2411A	Overdrive speed	8		24	
Presence-Detect Sample Time (Notes 1, 7)	t_{MSP}	DS2411	Standard speed	60		75	μs
		DS2411A	Standard speed	60		75	
		DS2411	Overdrive $V_{CC} \geq 2.2V$ (Note 1)	6		10	
		DS2411	Overdrive $V_{CC} \geq 1.5V$ (Note 1)	8.5		10	
		DS2411A	Overdrive speed	6		10	
Presence-Detect Fall Time (Notes 4, 16)	t_{FPD}	DS2411	Standard speed	0.4		8	μs
		DS2411	Overdrive speed	0.05		1	
I/O PIN, 1-Wire WRITE							
Write-0 Low Time (Notes 1, 8, 17)	t_{W0L}	DS2411	Standard speed	60		120	μs
		DS2411A	Standard speed	60		120	
		DS2411	Overdrive $V_{CC} \geq 2.2V$	6		16	
		DS2411	Overdrive $V_{CC} \geq 1.5V$	8		16	
		DS2411A	Overdrive	6		15.5	
Write-1 Low Time (Notes 1, 8, 17)	t_{W1L}	DS2411	Standard speed	5		15	μs
		DS2411A	Standard speed	1		15	
		DS2411	Overdrive speed	1		2.0	
		DS2411A	Overdrive speed	0.25		2	
I/O PIN, 1-Wire READ							
Read Low Time (Notes 1, 9)	t_{RL}	DS2411	Standard speed	5		$15 - \delta$	μs
		DS2411A	Standard speed	5		$15 - \delta$	
		DS2411	Overdrive speed	1		$2 - \delta$	
		DS2411A	Overdrive speed	0.25		$2 - \delta$	
Read Sample Time (Notes 1, 9)	t_{MSR}	DS2411	Standard speed	$t_{RL} + \delta$		15	μs
		DS2411A	Standard speed			15	
		DS2411	Overdrive speed			2	
		DS2411A	Overdrive speed			2	

- Note 1:** System requirement.
- Note 2:** Full R_{PUP} range is guaranteed by design and simulation and not production tested. Production testing performed at a fixed R_{PUP} value. Maximum allowable pullup resistance is a function of the number of 1-Wire devices in the system and 1-Wire recovery times. The specified value here applies to systems with only one device and with the minimum 1-Wire recovery times. For more heavily loaded systems, an active pullup such as that found in the DS2480B may be required.
- Note 3:** Applies to a single device attached to a 1-Wire line.
- Note 4:** Guaranteed by design, simulation only. Not production tested.
- Note 5:** Maximum value represents the internal parasite capacitance when V_{PUP} is first applied. Once the parasite capacitance is charged, it does not affect normal communication.
- Note 6:** The voltage on I/O must be less than or equal to V_{ILMAX} whenever the master drives the line low.
- Note 7:** The interval after t_{RSTL} during which a bus master can read a logic '0' on I/O if there is a DS28E07 present. The power-up presence detect pulse could be outside this interval but will be complete within 1.5ms (DS2411) or 2ms (DS2411A) after power-up.
- Note 8:** ϵ in Figure 7 represents the time required for the pullup circuitry to pull the voltage on I/O up from V_{IL} to V_{IH} . The actual maximum duration for the master to pull the line low is $t_{W1LMAX} + t_F - \epsilon$ and $t_{W0LMAX} + t_F - \epsilon$, respectively.
- Note 9:** δ in Figure 7 represents the time required for the pullup circuitry to pull the voltage on I/O up from V_{IL} to the input-high threshold of the bus master. The actual maximum duration for the master to pull the line low is $t_{RLMAX} + t_F$.
- Note 10:** V_{TL} and V_{TH} are functions of V_{CC} and temperature. The V_{TH} and V_{TL} maximum specifications are valid at $V_{CC} = 5.25V$. In any case, $V_{TL} < V_{TH} < V_{CC}$.
- Note 11:** Voltage below which during a falling edge on I/O, a logic '0' is detected.
- Note 12:** Voltage above which during a rising edge on I/O, a logic '1' is detected.
- Note 13:** After V_{TH} is crossed during a rising edge on I/O, the voltage on I/O has to drop by V_{HY} to be detected as logic '0'.
- Note 14:** The I-V characteristic is linear for voltages less than 1V.
- Note 15:** The earliest recognition of a negative edge is possible at t_{REH} after V_{TH} has been reached on the previous edge.
- Note 16:** The interval during the negative edge on I/O at the beginning of a presence-detect pulse between the time at which the voltage is 90% of V_{PUP} and the time the voltage is 10% of V_{PUP} .
- Note 17:** The interval begins when the voltage drops below V_{TL} during a negative edge on I/O and ends when the voltage rises above V_{TH} during a positive edge on I/O.
- Note 18:** V_{TL} , V_{TH} , and V_{HY} are a function of the internal supply voltage, which is a function of V_{PUP} , R_{PUP} , 1-Wire timing, and capacitive loading on I/O. Lower V_{PUP} , higher R_{PUP} , shorter t_{REC} , and heavier capacitive loading all lead to lower values of V_{TL} , V_{TH} , and V_{HY} .
- Note 19:** Defines the maximum possible bit rate. Equal to $1/(t_{W0LMIN} + t_{RECMIN})$.

OPERATION

The DS2411's registration number is accessed through a single data line. The 48-bit serial number, 8-bit family code, and 8-bit CRC are retrieved using the Analog Devices 1-Wire protocol. This protocol defines bus transactions in terms of the bus state during specified time slots that are bus-master-generated falling edges on the I/O pin. All data is read and written least significant bit first. The DS2411 requires a delay between V_{CC} power-up and initial 1-Wire communication, t_{PWRP} (1200 μ s). The DS2411A requires a delay between I/O power-up and initial 1-Wire communication of 2ms. During this time the DS2411 or DS2411A may issue presence-detect pulses.

1-Wire BUS SYSTEM

The 1-Wire bus has a single bus master and one or more slaves. In all instances, the DS2411 is a slave device. The bus master is typically a microcontroller. The discussion of this bus system is broken down into three topics: hardware configuration, transaction sequence, and 1-Wire signaling (signal type and timing).

Hardware Configuration

The 1-Wire bus has a single data line, I/O. It is important that each device on the bus be able to drive I/O at the appropriate time. To facilitate this, each device has an open-drain or three-state output. The DS2411 has an open-drain output with an internal circuit equivalent to that shown in Figure 3. The bus master can have the same equivalent circuit. If a bidirectional pin is not available on the master, separate output and input pins can be connected together. The bus requires a pullup resistor at the master end of the bus, as shown in Figure 4. A multidrop bus consists of a 1-Wire bus with multiple slaves attached. The 1-Wire bus has a maximum data rate of 15.4kbps in standard speed and 125kbps in overdrive.

The idle state for the 1-Wire bus is high. If a transaction needs to be suspended for any reason, I/O must remain high if the transaction is to be resumed. If the bus is pulled low, slave devices on the bus will interpret the low as either a timeslot, or a reset depending on the duration.

Figure 1. DS2411 REGISTRATION NUMBER

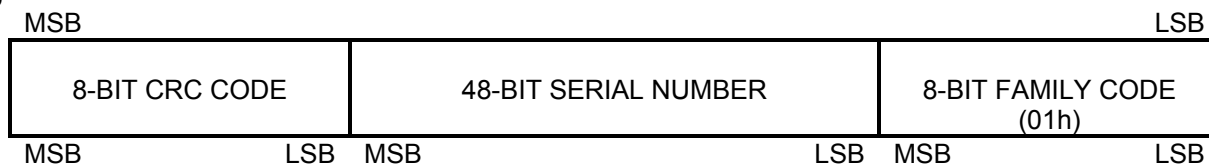

Figure 2. 1-Wire CRC GENERATOR

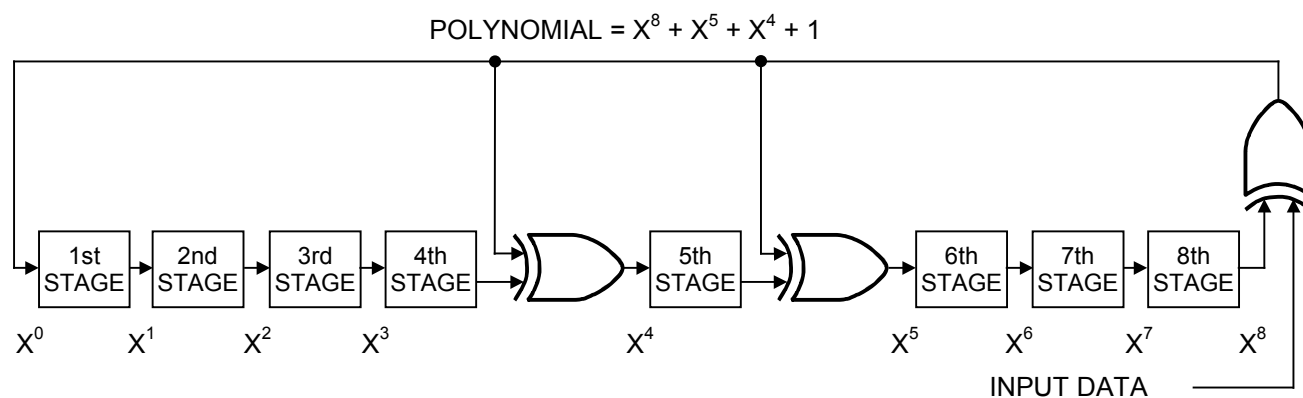

Figure 3. DS2411 EQUIVALENT CIRCUIT

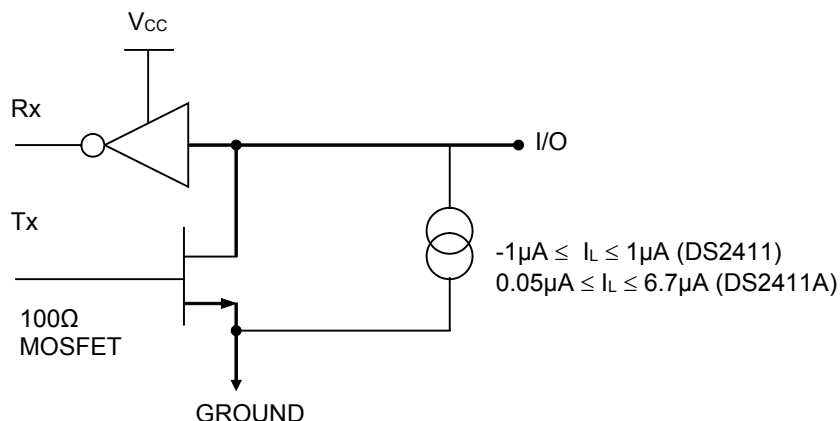
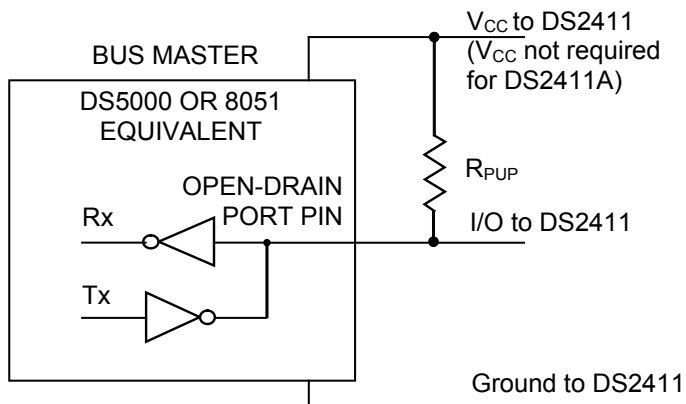

Figure 4. BUS MASTER CIRCUIT

R_{PUP} must be between 0.3 k Ω and 2.2 k Ω . The optimal value depends on the 1-Wire communication speed and the bus load characteristics.

TRANSACTION SEQUENCE

The communication sequence for accessing the DS2411 through the 1-Wire bus is as follows:

- Initialization
- ROM Function Command
- Read Data

INITIALIZATION

All transactions on the 1-Wire bus begin with an initialization sequence. The initialization sequence consists of a reset pulse transmitted by the bus master followed by a presence pulse(s) transmitted by the slave(s). The presence pulse lets the bus master know that the DS2411 is on the bus and is ready to operate. For more details, see the *1-Wire Signaling* section.

ROM FUNCTION COMMANDS

Once the bus master has detected a presence, it can issue one of the three ROM function commands. All ROM function command codes are 1 byte long. A list of these commands follows (see the flowchart in Figure 5).

Read ROM [33h]

This command allows the bus master to read the DS2411's 8-bit family code, unique 48-bit serial number, and 8-bit CRC. This command should only be used if there is a single slave device on the bus. If more than one slave is present on the bus, a data collision results when all slaves try to transmit at the same time (open drain produces a wired-AND result), and the resulting registration number read by the master will be invalid.

Search ROM [F0h]

When a system is initially brought up, the bus master might not know the number of devices on the 1-Wire bus or their registration numbers. By taking advantage of the wired-AND property of the bus, the master can use a process of elimination to identify the registration numbers of all slave devices. For each bit of the registration number, starting with the least significant bit, the bus master issues a triplet of time slots. On the first slot, each slave device participating in the search outputs the true value of its registration number bit. On the second slot, each slave device participating in the search outputs the complemented value of its registration number bit. On the third slot, the master writes the true value of the bit to be selected. All slave devices that do not match the bit written by the master stop participating in the search. If both of the read bits are zero, the master knows that slave devices exist with both states of the bit. By choosing which state to write, the bus master branches in the romcode tree. After one complete pass, the bus master knows the registration number of a single device. Additional passes identify the registration numbers of the remaining devices. Refer to [App Note 187: 1-Wire Search Algorithm](#) for a detailed discussion, including an example.

Overdrive Skip ROM [3Ch]

This command causes all overdrive-capable slave devices on the 1-Wire network to enter overdrive speed (OD = 1). All communication following this command has to occur at overdrive speed until a reset pulse of minimum 480µs duration resets all devices on the bus to regular speed (OD = 0).

To subsequently address a specific overdrive-supporting device, a reset pulse at overdrive speed has to be issued followed by a read ROM or search ROM command sequence. Overdrive speeds up the time for the search process.

Figure 5. ROM FUNCTIONS FLOW CHART

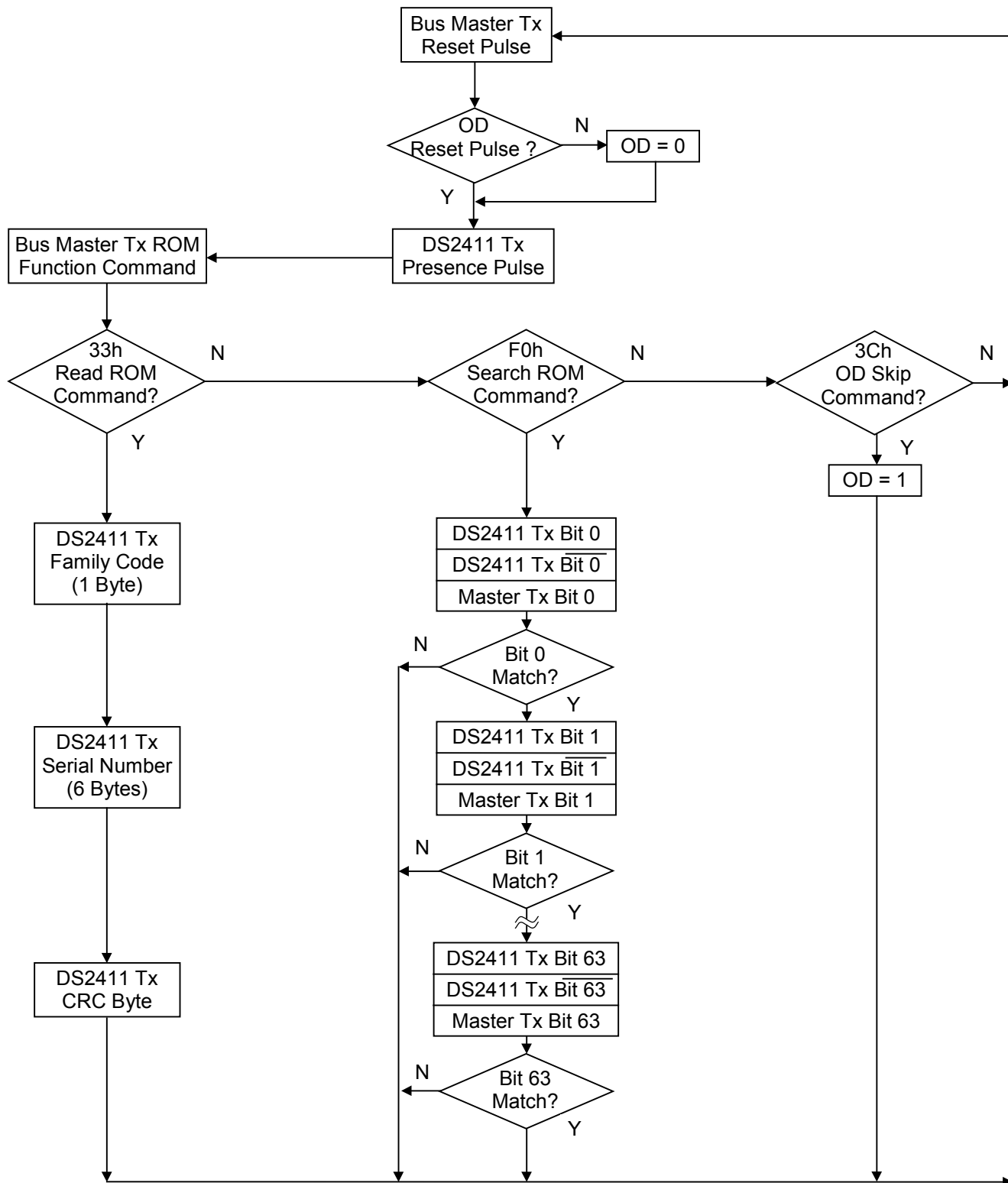

1-Wire SIGNALING

The DS2411 requires strict protocols to ensure data integrity. The protocol consists of four types of signaling on one line: Reset Sequence with Reset Pulse and Presence Pulse, Write 0, Write 1, and Read Data. Except for the presence pulse the bus master initiates all these signals. The DS2411 can communicate at two different speeds: standard speed and Overdrive speed. If not explicitly set into the Overdrive mode, the DS2411 will communicate at standard speed. While in Overdrive Mode the fast timing applies to all waveforms.

To get from idle to active, the voltage on the 1-Wire line needs to fall from V_{PUP} below the threshold V_{TL} . To get from active to idle, the voltage needs to rise from V_{ILMAX} past the threshold V_{TH} . The voltage V_{ILMAX} is relevant for the DS2411 when determining a logical level, but not for triggering any events.

The initialization sequence required to begin any communication with the DS2411 is shown in Figure 6. A Reset Pulse followed by a Presence Pulse indicates the DS2411 is ready to receive data, given the correct ROM and memory function command. In a mixed population network, the reset low time t_{RSTL} needs to be long enough for the slowest 1-Wire slave device to recognize it as a reset pulse. If the bus master uses slew-rate control on the falling edge, it must pull down the line for $t_{RSTL} + t_F$ to compensate for the edge. A t_{RSTL} duration of 480 μ s or longer will exit the Overdrive Mode returning the device to standard speed. If the DS2411 is in Overdrive Mode and t_{RSTL} is no longer than 80 μ s, the device will remain in Overdrive Mode.

After the bus master has released the line it goes into receive mode (RX). Now, the 1-Wire bus is pulled to V_{PUP} via the pullup resistor or, in case of a DS2480B driver, by active circuitry. When the threshold V_{TH} is crossed, the DS2411 waits for t_{PDH} and then transmits a Presence Pulse by pulling the line low for t_{PDL} . To detect a presence pulse, the master must test the logical state of the 1-Wire line at t_{MSP} .

The t_{RSTH} window must be at least the sum of t_{PDHMAX} , t_{PDLMAX} , and t_{RECMIN} . Immediately after t_{RSTH} is expired, the DS2411 is ready for data communication. In a mixed population network, t_{RSTH} should be extended to minimum 480 μ s at standard speed and 48 μ s at Overdrive speed to accommodate other 1-Wire devices.

Read/Write Time Slots

Data communication with the DS2411 takes place in time slots that carry a single bit each. Write time slots transport data from bus master to slave. Read time-slots transfer data from slave to master. The definitions of the write and read time slots are illustrated in Figure 7.

All communication begins with the master pulling the data line low. As the voltage on the 1-Wire line falls below the threshold V_{TL} , the DS2411 starts its internal timing generator that determines when the data line will be sampled during a write time slot and how long data will be valid during a read time slot.

Master to Slave

For a **write-one** time slot, the voltage on the data line must have crossed the V_{THMAX} threshold after the write-one low time t_{W1LMAX} is expired. For a **write-zero** time slot, the voltage on the data line must stay below the V_{THMIN} threshold until the write-zero low time t_{W0LMIN} is expired. For most reliable communication the voltage on the data line should not exceed V_{ILMAX} during the entire t_{W0L} window. After the V_{THMAX} threshold has been crossed, the DS2411 needs a recovery time t_{REC} before it is ready for the next time slot.

INITIALIZATION PROCEDURE

Figure 6. Reset and Presence Pulse

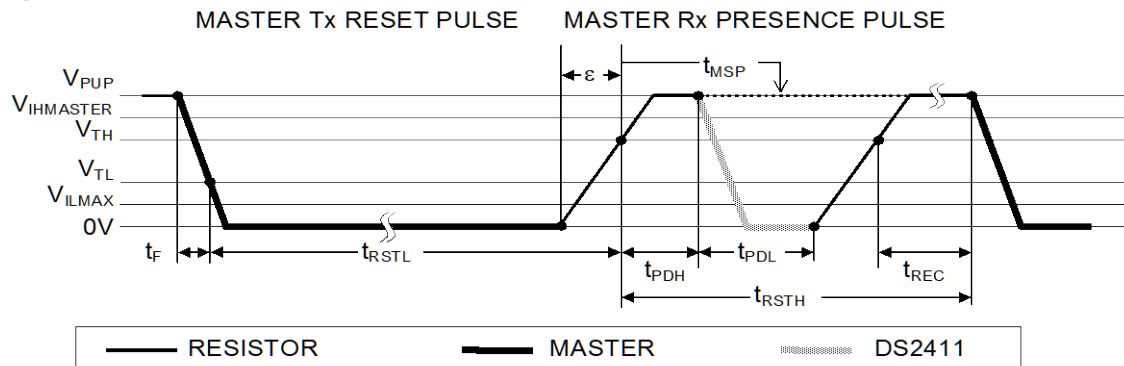

READ/WRITE TIMING DIAGRAM

Figure 7a. Write-One Time Slot

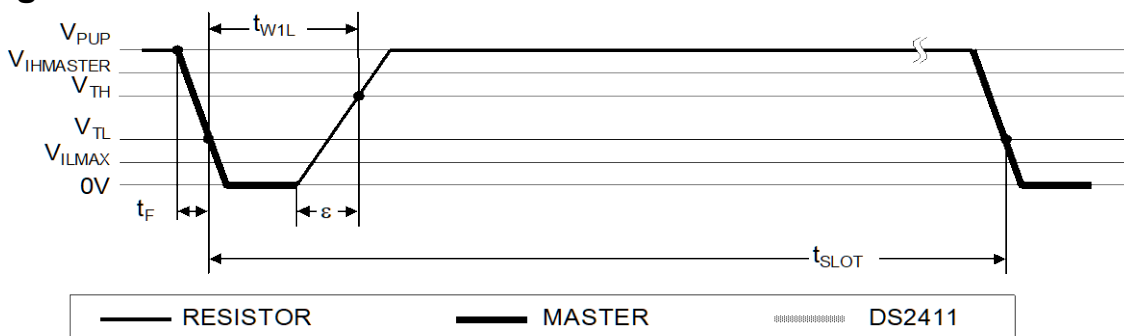

Figure 7b. Write-Zero Time Slot

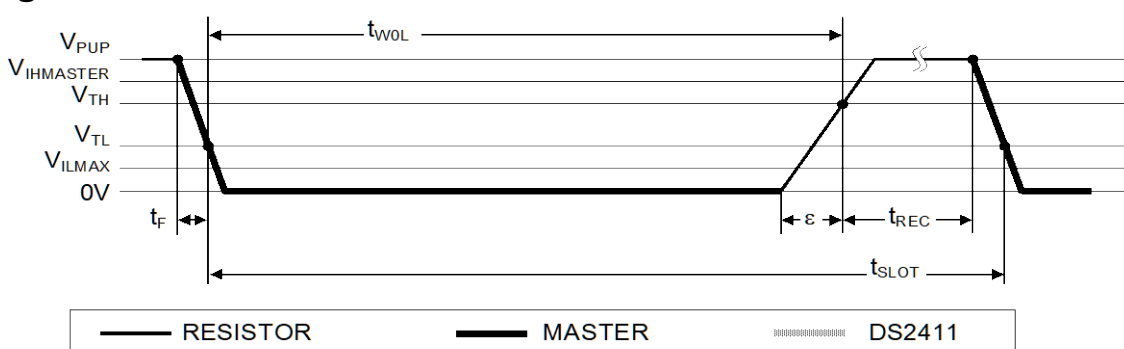
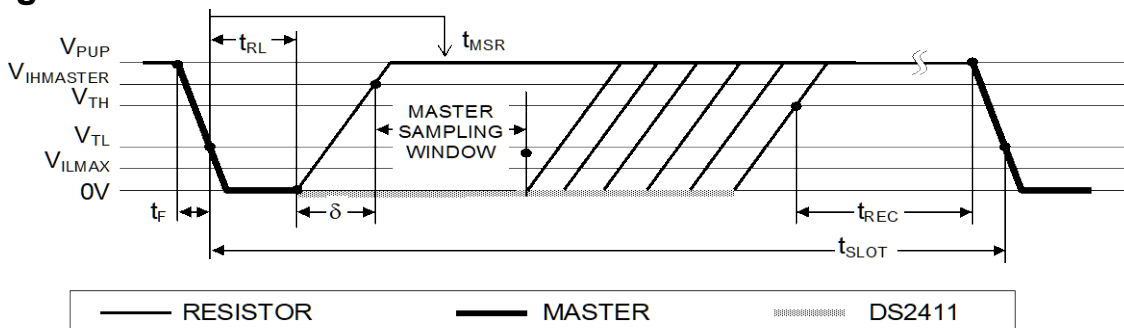

Figure 7c. Read-Data Time Slot



Slave to Master

A **read-data** time slot begins like a write-one time slot. The voltage on the data line must remain below V_{TLMIN} until the read low time t_{RL} is expired. During the t_{RL} window, when responding with a 0, the DS2411 will start pulling the data line low; its internal timing generator determines when this pull-down ends and the voltage starts rising again. When responding with a 1, the DS2411 will not hold the data line low at all, and the voltage starts rising as soon as t_{RL} is over.

The sum of $t_{RL} + \delta$ (rise time) on one side and the internal timing generator of the DS2411 on the other side define the master sampling window (t_{MSRMIN} to t_{MSRMAX}) in which the master must perform a read from the data line. For most reliable communication, t_{RL} should be as short as permissible and the master should read close to but no later than t_{MSRMAX} . After reading from the data line, the master must wait until t_{SLOT} is expired. This guarantees sufficient recovery time t_{REC} for the DS2411 to get ready for the next time slot.

Improved Network Behavior

In a 1-Wire environment, line termination is possible only during transients controlled by the bus master (1-Wire driver). 1-Wire networks therefore are susceptible to noise of various origins. Depending on the physical size and topology of the network, reflections from end points and branch points can add up or cancel each other to some extent. Such reflections are visible as glitches or ringing on the 1-Wire communication line. A glitch during the rising edge of a time slot can cause a slave device to lose synchronization with the master and, as a consequence, result in a search ROM command coming to a dead end. For better performance in network applications, the DS2411 uses a new 1-Wire front end, which makes it less sensitive to noise and also reduces the magnitude of noise injected by the slave device itself.

The 1-Wire front end of the DS2411 differs from traditional slave devices in four characteristics.

- 1) The falling edge of the presence pulse has a controlled slew rate. This provides a better match to the line impedance than a digitally switched transistor, converting the high frequency ringing known from traditional devices into a smoother low-bandwidth transition. The slew rate control is specified by the parameter t_{FPD} , which has different values for standard and Overdrive speed. This function is only available for the V_{CC} -powered version.
- 2) There is additional low-pass filtering in the circuit that detects the falling edge at the beginning of a time slot. This reduces the sensitivity to high-frequency noise. As a consequence, the duration of the setup time t_{SU} at standard speed is larger than with traditional devices. This additional filtering does not apply at Overdrive speed.
- 3) There is a hysteresis at the low-to-high switching threshold V_{TH} . If a negative glitch crosses V_{TH} but doesn't go below $V_{TH} - V_{HY}$, it will not be recognized (Figure 8, Case A). The hysteresis is effective at any 1-Wire speed.
- 4) There is a time window specified by the rising edge hold-off time t_{REH} during which glitches will be ignored, even if they extend below $V_{TH} - V_{HY}$ threshold (Figure 8, Case B, $t_{GL} < t_{REH}$). Deep voltage droops or glitches that appear late after crossing the V_{TH} threshold and extend beyond the t_{REH} window cannot be filtered out and will be taken as beginning of a new time slot (Figure 8, Case C, $t_{GL} \geq t_{REH}$). The duration of the hold-off time is independent of the 1-Wire speed.

Only devices which have the parameters V_{HY} and t_{REH} specified in their electrical characteristics use the improved 1-Wire front end.

NOISE SUPPRESSION SCHEME Figure 8

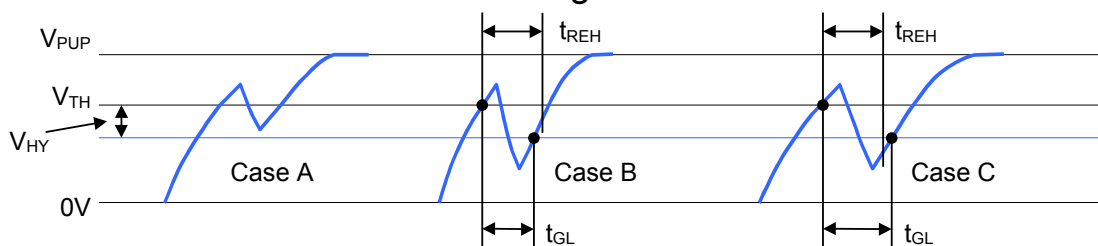

CRC GENERATION

To validate the registration number transmitted from the DS2411, the bus master can generate a CRC value from the 8-bit family code and unique 48-bit serial number as it is received. If the CRC matches the last 8 bits of the registration number, the transmission is error free.

The equivalent polynomial function of this CRC is: $CRC = x^8 + x^5 + x^4 + 1$. For more information on generating CRC values see [Application Note 27](#).

CUSTOM DS2411

Customization of a portion of the unique 48-bit serial number by the customer is available. Maxim will register and assign a specific customer ID in the 12 most significant bits of the 48-bit field. The next most significant bits are selectable by the customer as a starting value, and the least significant bits are non-selectable and will be automatically incremented by one. Certain quantities and conditions apply for these custom parts. Contact your Maxim sales representative for more information.

PACKAGE INFORMATION

For the latest package outline information and land patterns (footprints), go to www.maxim-ic.com/packages. Note that a "+", "#", or "-" in the package code indicates RoHS status only. Package drawings may show a different suffix character, but the drawing pertains to the package regardless of RoHS status.

PACKAGE TYPE	PACKAGE CODE	OUTLINE NO.	LAND PATTERN
SOT23-3	U3+2	21-0051	90-0179
6 TSOC	D6+1	21-0382	90-0321
4 Flip Chip	BF411-1	21-0282	Refer to 21-0282

REVISION HISTORY

REVISION DATE	DESCRIPTION	PAGES CHANGED
020703	Initial release	—
052003	Corrected the Flip Chip pin configuration.	1
	Section <i>1-Wire Signaling</i> rewritten.	8, 10
	Added section <i>Improved Network Behavior</i> .	10, 11
122106	Added flip chip top marking and URL to package outline drawing. Added SOT23-3 and TSOC lead-free part numbers to <i>Ordering Information</i> .	1
11/11	Updated ordering information, lead temperature, soldering temperature.	1, 2
	In the <i>Electrical Characteristics</i> table, applied note 11 to the t_{WOL} specification; deleted ε from the t_{W1L} specification; corrected the t_{RL} specification (replaced ε with δ , applied note 12), and added more details to notes 4, 11, and 12.	3, 4
	Deleted the DS2480B (5V operation) master circuit from Figure 4.	5
	Updated the <i>Package Information</i> section and added <i>Revision History</i> .	11, 12
12/21	Updated title, <i>Features</i> , <i>Pin Description</i> , <i>Ordering Information</i> , <i>Description</i> , <i>Absolute Maximum Ratings</i> , <i>Electrical Characteristics</i> , <i>Operation</i> , <i>Figure 3</i> , <i>Figure 4</i> , <i>Improved Network Behavior</i> , and <i>Package Information</i>	1-5, 10, 11
4/22	Removed DS2411A from the title	1