

Am110/210/310

Voltage Follower

Distinctive Characteristics

- The Am110/210/310 are functionally, electrically, and pin-for-pin equivalent to the National LM 110/210/310
- Slew rate: $30V/\mu s$
- Small signal bandwidth: 20 MHz
- Input current: 10 nA max. over temperature
- Supply voltage range: $\pm 5V$ to $\pm 18V$
- 100% reliability assurance testing in compliance with MIL STD 883.
- Electrically tested and optically inspected dice for hybrid manufacturers.
- Available in metal can, hermetic dual-in-line or hermetic flat packages.

FUNCTIONAL DESCRIPTION

The Am110/210/310 are voltage followers featuring high-speed, low-input currents and large input voltage range. They are internally compensated with provision for external offset adjustment. Operation over wide supply voltages and temperature is possible.

FUNCTIONAL DIAGRAM

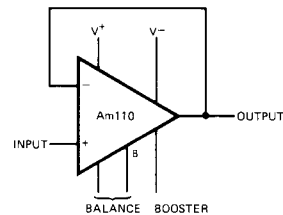

LIC-676

TYPICAL APPLICATION

Fast Integrator With Low-Input Current

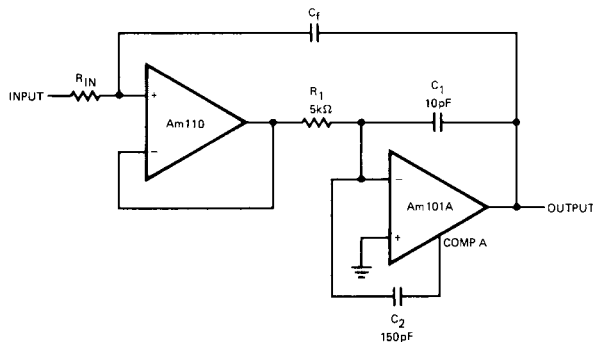

LIC-677

ORDERING INFORMATION

Part Number	Package Type	Temperature Range	Order Number
Am310	TO-99	0°C to +70°C	LM310H
	DIP	0°C to +70°C	LM310D
	Flat Package	0°C to +70°C	LM310F
	Molded DIP	0°C to +70°C	LM310N
	Dice	0°C to +70°C	LD310
Am210	TO-99	-25°C to +85°C	LM210H
	DIP	-25°C to +85°C	LM210D
	Flat Pak	-25°C to +85°C	LM210F
Am110	TO-99	-55°C to +125°C	LM110H
	DIP	-55°C to +125°C	LM110D
	Flat Package	-55°C to +125°C	LM110F
	Dice	-55°C to +125°C	LD110

CONNECTION DIAGRAMS

Top Views

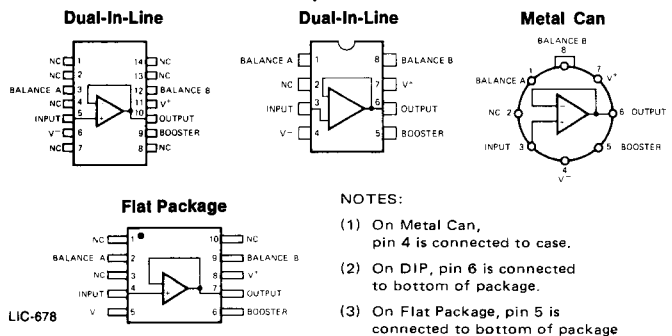

LIC-678

MAXIMUM RATINGS

Supply Voltage	± 18 V
Internal Power Dissipation (Note 1)	500 mW
Input Voltage (Note 2)	± 15 V
Output Short-Circuit Duration (Note 3)	Indefinite
Operating Temperature Range	Am110 Am210 Am310
	-55°C to $+125^{\circ}\text{C}$ -25°C to $+85^{\circ}\text{C}$ 0°C to $+70^{\circ}\text{C}$
Storage Temperature Range	-65°C to $+150^{\circ}\text{C}$
Lead Temperature (soldering, 60 sec)	300°C

ELECTRICAL CHARACTERISTICS ($T_A = 25^{\circ}\text{C}$ unless otherwise specified) (Note 4)

Parameter (see definitions)	Conditions	Am310			Am110 Am210			Units
		Min	Typ	Max	Min	Typ	Max	
Input Offset Voltage			2.5	7.5		1.5	4.0	mV
Input Bias Current			2.0	7.0		1.0	3.0	nA
Input Resistance		10^4	10^6		10^4	10^6		M Ω
Input Capacitance			1.5			1.5		pF
Large-Signal Voltage Gain	$R_L = 8\text{ k}\Omega$, $V_{\text{out}} = \pm 10\text{ V}$, $V_S = \pm 15\text{ V}$	0.999	0.9999		0.999	0.9999		V/V
Output Resistance			0.75	2.5		0.75	2.5	Ω
Supply Current			3.9	5.5		3.9	5.5	mA
Slew Rate	$V_S = \pm 15\text{ V}$, $V_{\text{IN}} = \pm 10\text{ V}$, $R_L = 10\text{ k}\Omega$		30			30		V/ μs

The Following Specifications Apply Over The Operating Temperature Ranges

Input Offset Voltage			10.0			6.0		mV
Input Bias Current			10.0			10.0		nA
Large-Signal Voltage Gain	$R_L = 10\text{ k}\Omega$, $V_{\text{out}} = \pm 10\text{ V}$, $V_S = \pm 15\text{ V}$	0.999			0.999			V/V
Output Voltage Swing (Note 5)	$R_L = 10\text{ k}\Omega$, $V_S = \pm 15\text{ V}$	± 10			± 10			V
Supply Current	$T_A = +125^{\circ}\text{C}$				2.0	4.0		mA
Supply Voltage Rejection Ratio	$\pm 5\text{ V} \leq V_S \leq \pm 18\text{ V}$	70			70			dB
Average Temperature Coefficient of Input Offset Voltage	$0^{\circ} \leq T_A \leq 70^{\circ}\text{C}$		10					$\mu\text{V}/^{\circ}\text{C}$
	$-55^{\circ}\text{C} \leq T_A \leq 85^{\circ}\text{C}$					6		$\mu\text{V}/^{\circ}\text{C}$
	$+85^{\circ}\text{C} \leq T_A \leq 125^{\circ}\text{C}$					12		$\mu\text{V}/^{\circ}\text{C}$

- Notes: 1. Derate Metal Can package $6.8\text{ mW}/^{\circ}\text{C}$ for operation at ambient temperatures above 75°C , the Dual In-Line at $9\text{ mW}/^{\circ}\text{C}$ for operation at ambient temperatures above 95°C , and the Flat Packages at $5.4\text{ mW}/^{\circ}\text{C}$ for operation at ambient temperatures above 57°C .
2. For supply voltages less than $\pm 15\text{ V}$, the maximum input voltage is equal to the supply voltage.
3. To prevent damage when the output is shorted, it is necessary to insert a resistor larger than $2\text{ k}\Omega$ in series with the input. Continuous short circuit is allowed for case temperatures to 125°C and ambient temperatures to 70°C for the 110/210. For 310, the corresponding temperatures are 70°C and 55°C respectively.
4. Unless otherwise specified, these specifications apply for supply voltages from ± 5 to $\pm 18\text{ V}$.
5. Greater output voltage swing can be obtained by connecting a resistor from booster terminal to $V-$.

AC TEST CIRCUIT

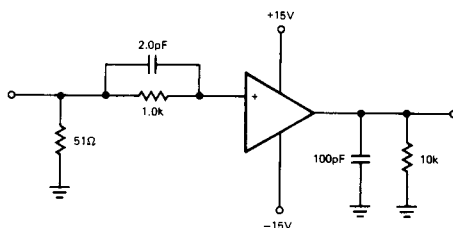

PERFORMANCE CURVES

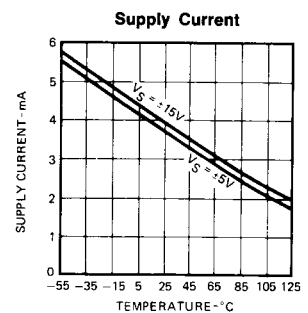
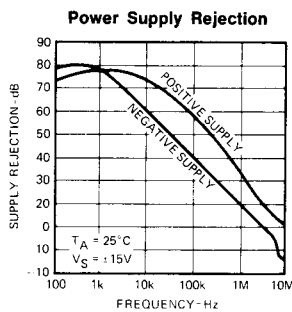
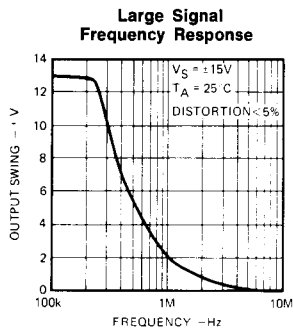
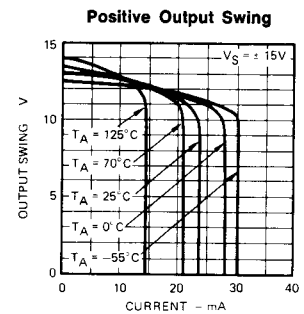
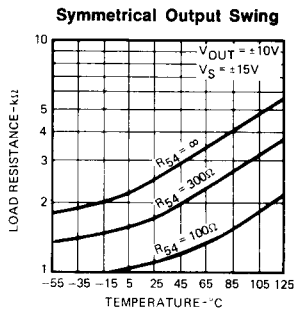
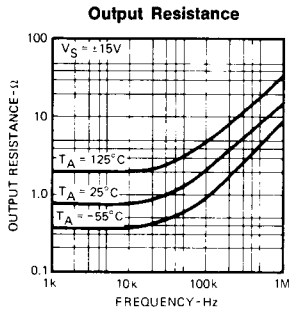
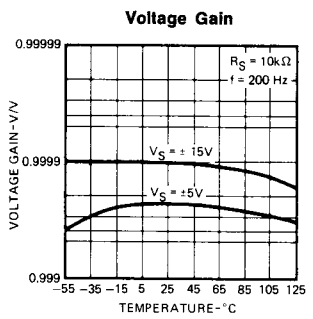
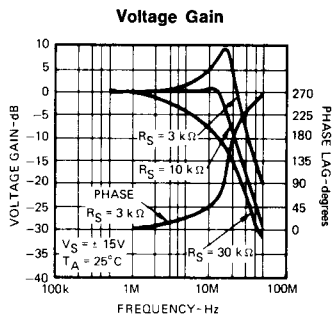
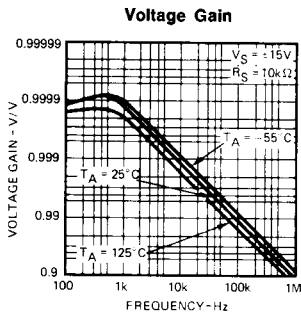
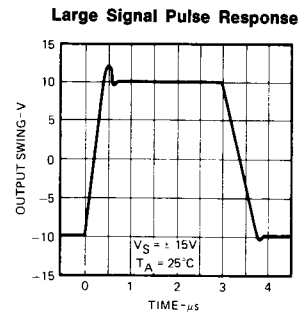
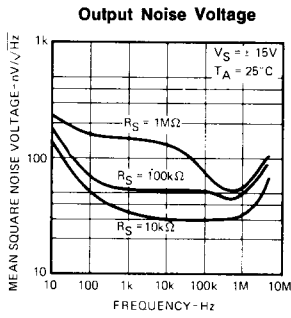
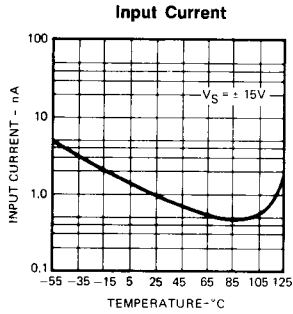

APPLICATIONS

Offset Nulling Circuit

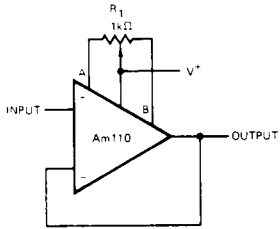

LIC-681

Increasing Negative Swing Under Load

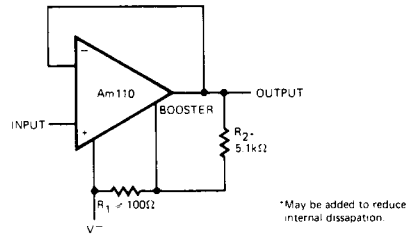

LIC-682

Differential Input Instrumentation Amplifier

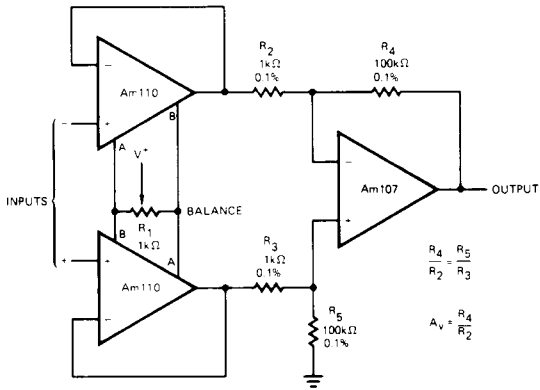

LIC-683

Fast Inverting Amplifier With High Input Impedance

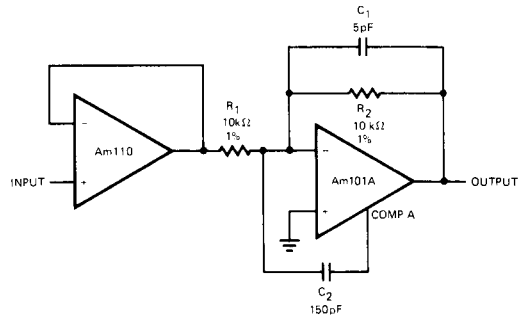

LIC-684

Metallization and Pad Layout

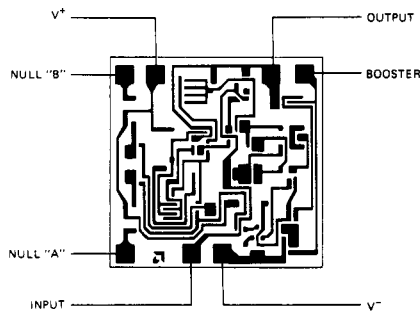

48 x 48 Mils

