

## S286-15 Oil Level Switch

Document ref.: DDS\_S286-15

25-Jan-21

Rev. 1

The S286 is an active device designed to give an alarm signal if liquid falls below, or rises above, a preset level. It can be specified with a delay to eliminate false alarms due to turbulence. Containing a factory programmable microprocessor, the switch offers sink to ground or source voltage output. For high accuracy the S286 is ideally mounted horizontally at the point where an alarm or control signal is required.

<b>Part</b>	S286-15
<b>Description</b>	1/2" NPTF, PU 1 LIQ, SI 10 FA, SI LIQ
<b>Prod. Group</b>	Oil Level Switch
<b>Technology</b>	Capacitance
<b>Liquid</b>	Mineral Oil
<b>Output Type</b>	Sink (Open collector)
<b>Connector</b>	Metri-pack 150 - 4 Pins
<b>Thread</b>	1/2" NPTF

### Performance

Output	Sink in Liquid
Alarm Delay	10 s (Factory Set)
Power Up	in Liquid
Switch Sense	Level Falling

### Materials

Body	Brass
Probe	PTFE
Terminals	Brass, Tin Plated
Seals	EDPM, FVMQ
Connector	30% Glass Filled Nylon
Thread Seal	Vibra-Seal 516

### Ratings

Sealing	IP67
Pressure	5 Bar (max)
Drop	1M to concrete
Vibration	15.3 Grms
Temperature	-40 to +125 C
EMC	ISO13766:2006

### Electricals

Supply Voltage	9-36 VDC
Supply Current	7 mA + source output

### Harness Information

Connector	M/P 150-4P
Source Output	Pin A
Sink Output	Pin D
+ve supply location	Pin C
Ground	Pin B

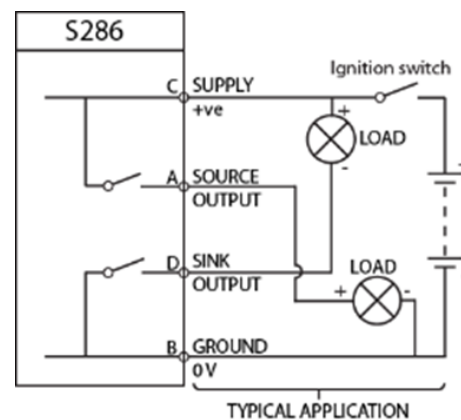
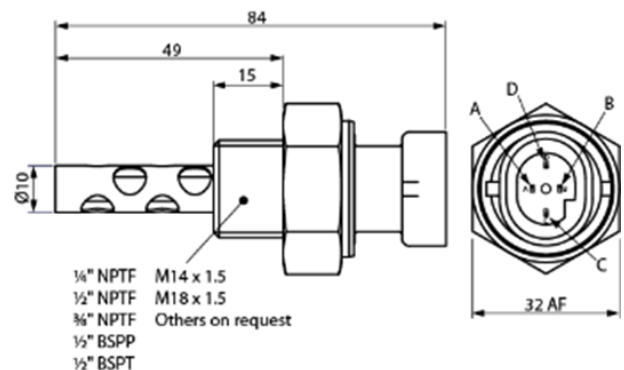

NOTE: IF SINK ONLY OUTPUT IS REQUIRED THEN PIN A IS NOT USED.