

1200V XPT™ IGBT GenX3™ w/ Diode

IXYH40N120B3D1

Extreme Light Punch Through
IGBT for 5-30 kHz Switching

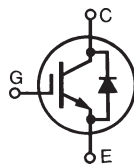

$V_{CES} = 1200V$
 $I_{C110} = 40A$
 $V_{CE(sat)} \leq 2.9V$
 $t_{fi(typ)} = 183ns$

Symbol	Test Conditions	Maximum Ratings	
V_{CES}	$T_J = 25^\circ C$ to $150^\circ C$	1200	V
V_{CGR}	$T_J = 25^\circ C$ to $150^\circ C$, $R_{GE} = 1M\Omega$	1200	V
V_{GES}	Continuous	± 20	V
V_{GEM}	Transient	± 30	V
I_{C25}	$T_C = 25^\circ C$ (Chip Capability)	86	A
I_{C110}	$T_C = 110^\circ C$	40	A
I_{F110}	$T_C = 110^\circ C$	25	A
I_{CM}	$T_C = 25^\circ C$, 1ms	180	A
I_A	$T_C = 25^\circ C$	20	A
E_{AS}	$T_C = 25^\circ C$	400	mJ
SSOA (RBSOA)	$V_{GE} = 15V$, $T_{VJ} = 150^\circ C$, $R_G = 10\Omega$ Clamped Inductive Load	$I_{CM} = 80$ @ $V_{CE} \leq V_{CES}$	A
P_C	$T_C = 25^\circ C$	480	W
T_J		-55 ... +150	$^\circ C$
T_{JM}		150	$^\circ C$
T_{stg}		-55 ... +150	$^\circ C$
T_L	Maximum Lead Temperature for Soldering	300	$^\circ C$
T_{SOLD}	1.6 mm (0.062in.) from Case for 10s	260	$^\circ C$
M_d	Mounting Torque	1.13/10	Nm/lb.in.
Weight		6	g

TO-247 AD



G = Gate C = Collector
E = Emitter Tab = Collector

Features

- Optimized for 5-30kHz Switching
- Square RBSOA
- Positive Thermal Coefficient of $V_{ce(sat)}$
- Anti-Parallel Ultra Fast Diode
- Avalanche Rated
- International Standard Package

Advantages

- High Power Density
- Low Gate Drive Requirement

Applications

- Power Inverters
- UPS
- Motor Drives
- SMPS
- PFC Circuits
- Battery Chargers
- Welding Machines
- Lamp Ballasts

Symbol	Test Conditions ($T_J = 25^\circ C$, Unless Otherwise Specified)	Characteristic Values		
		Min.	Typ.	Max.
BV_{CES}	$I_C = 250\mu A$, $V_{GE} = 0V$	1200		V
$V_{GE(th)}$	$I_C = 250\mu A$, $V_{CE} = V_{GE}$	3.0		5.0 V
I_{CES}	$V_{CE} = V_{CES}$, $V_{GE} = 0V$ $T_J = 125^\circ C$			50 μA 500 μA
I_{GES}	$V_{CE} = 0V$, $V_{GE} = \pm 20V$			± 100 nA
$V_{CE(sat)}$	$I_C = 40A$, $V_{GE} = 15V$, Note 1 $T_J = 150^\circ C$		2.4 3.1	2.9 V V

Symbol	Test Conditions	Characteristic Values		
		Min.	Typ.	Max.
g_{fs}	$I_C = 40A, V_{CE} = 10V$, Note 1	13	22	S
C_{ies}	$V_{CE} = 25V, V_{GE} = 0V, f = 1MHz$		1690	pF
C_{oes}			157	pF
C_{res}			47	pF
$Q_{g(on)}$	$I_C = 40A, V_{GE} = 15V, V_{CE} = 0.5 \cdot V_{CES}$		87	nC
Q_{ge}			12	nC
Q_{gc}			38	nC
$t_{d(on)}$	Inductive load, $T_J = 25^\circ C$ $I_C = 40A, V_{GE} = 15V$ $V_{CE} = 0.5 \cdot V_{CES}, R_G = 10\Omega$ Note 2		22	ns
t_{ri}			50	ns
E_{on}			2.70	mJ
$t_{d(off)}$			177	ns
t_{fi}			183	ns
E_{off}			1.60	3.00 mJ
$t_{d(on)}$	Inductive load, $T_J = 125^\circ C$ $I_C = 40A, V_{GE} = 15V$ $V_{CE} = 0.5 \cdot V_{CES}, R_G = 10\Omega$ Note 2		24	ns
t_{ri}			60	ns
E_{on}			5.25	mJ
$t_{d(off)}$			205	ns
t_{fi}			206	ns
E_{off}			2.05	mJ
R_{thJC}			0.26	$^\circ C/W$
R_{thCS}		0.21		$^\circ C/W$

TO-247 (IXYH) Outline

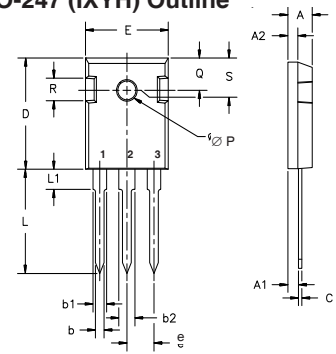

Terminals: 1 - Gate 2 - Collector
3 - Emitter

Dim.	Millimeter		Inches	
	Min.	Max.	Min.	Max.
A	4.7	5.3	.185	.209
A ₁	2.2	2.54	.087	.102
A ₂	2.2	2.6	.059	.098
b	1.0	1.4	.040	.055
b ₁	1.65	2.13	.065	.084
b ₂	2.87	3.12	.113	.123
C	.4	.8	.016	.031
D	20.80	21.46	.819	.845
E	15.75	16.26	.610	.640
e	5.20	5.72	0.205	0.225
L	19.81	20.32	.780	.800
L1		4.50		.177
∅P	3.55	3.65	.140	.144
Q	5.89	6.40	0.232	0.252
R	4.32	5.49	.170	.216
S	6.15	BSC	.242	BSC

Reverse Diode (FRED)

Symbol	Test Conditions	Characteristic Value		
		Min.	Typ.	Max.
V_F	$I_F = 30A, V_{GE} = 0V$, Note 1 $T_J = 150^\circ C$		1.6	3.0 V
I_{RM}	$I_F = 30A, V_{GE} = 0V, -di_F/dt = 100A/\mu s, T_J = 100^\circ C$			4 A
t_{rr}		$V_R = 300V, T_J = 100^\circ C$	100	ns
R_{thJC}				0.9 $^\circ C/W$

Notes:

1. Pulse test, $t \leq 300\mu s$, duty cycle, $d \leq 2\%$.
2. Switching times & energy losses may increase for higher $V_{CE}(\text{clamp})$, T_J or R_G .

IXYS Reserves the Right to Change Limits, Test Conditions, and Dimensions.

IXYS MOSFETs and IGBTs are covered by one or more of the following U.S. patents:	4,835,592	4,931,844	5,049,961	5,237,481	6,162,665	6,404,065 B1	6,683,344	6,727,585	7,005,734 B2	7,157,338B2
	4,860,072	5,017,508	5,063,307	5,381,025	6,259,123 B1	6,534,343	6,710,405 B2	6,759,692	7,063,975 B2	
	4,881,106	5,034,796	5,187,117	5,486,715	6,306,728 B1	6,583,505	6,710,463	6,771,478 B2	7,071,537	

Fig. 1. Output Characteristics @ $T_J = 25^\circ\text{C}$

Fig. 2. Extended Output Characteristics @ $T_J = 25^\circ\text{C}$

Fig. 3. Output Characteristics @ $T_J = 150^\circ\text{C}$

Fig. 4. Dependence of $V_{CE(sat)}$ on Junction Temperature

Fig. 5. Collector-to-Emitter Voltage vs. Gate-to-Emitter Voltage

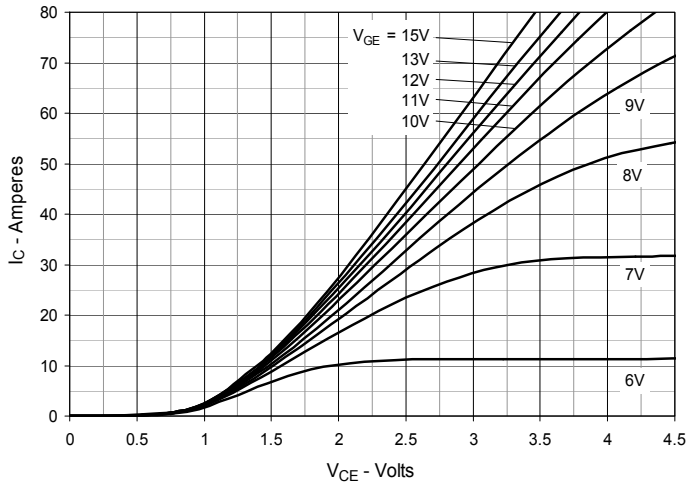
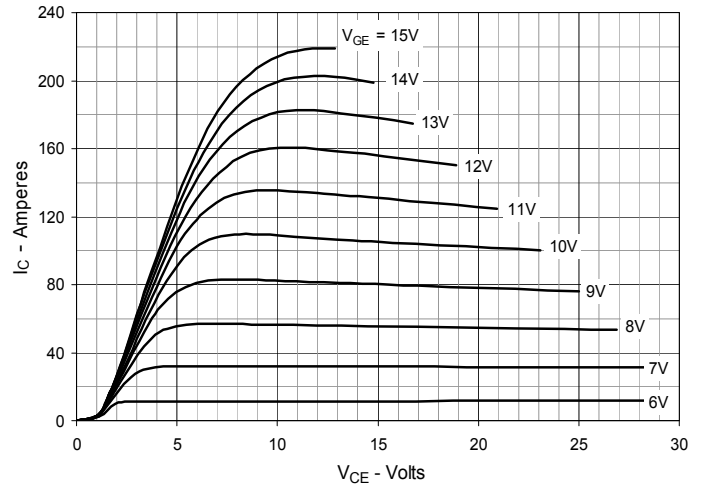
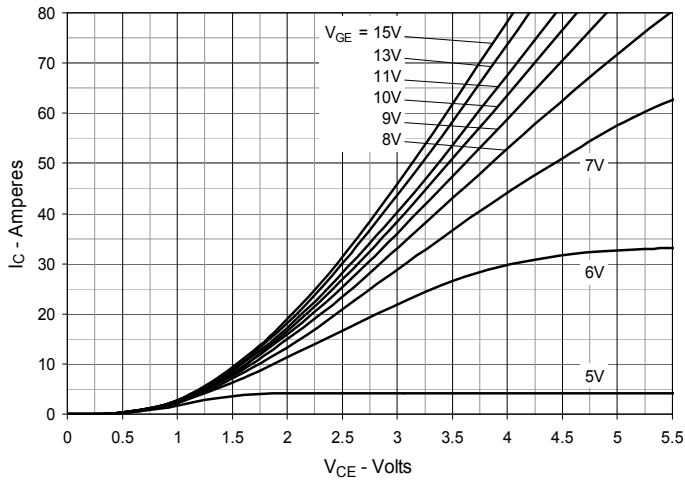
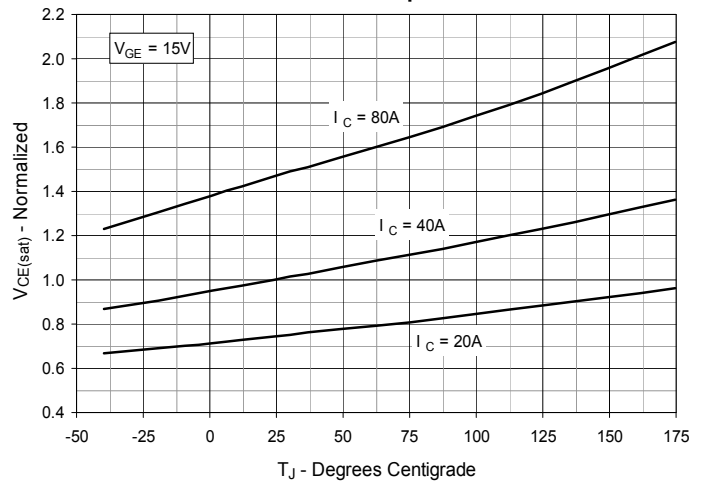
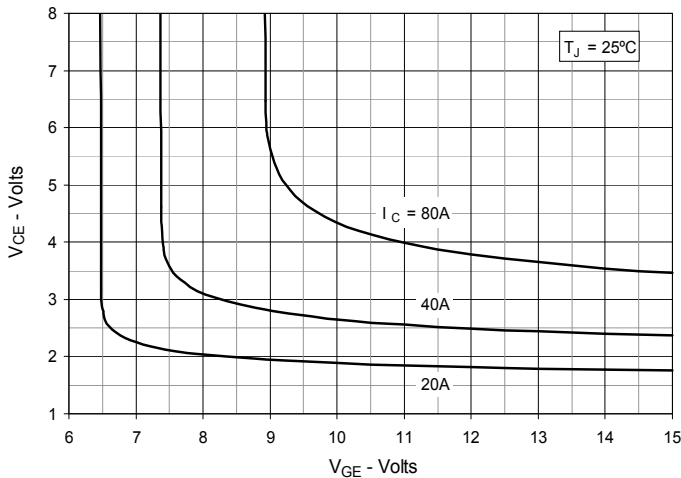
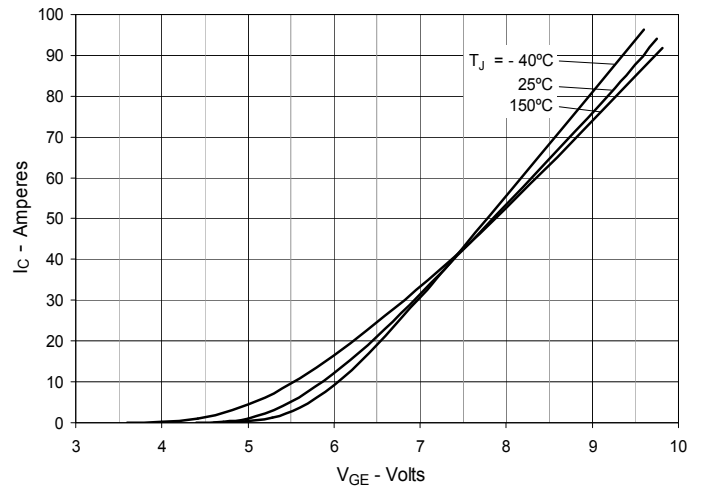
Fig. 6. Input Admittance

Fig. 7. Transconductance

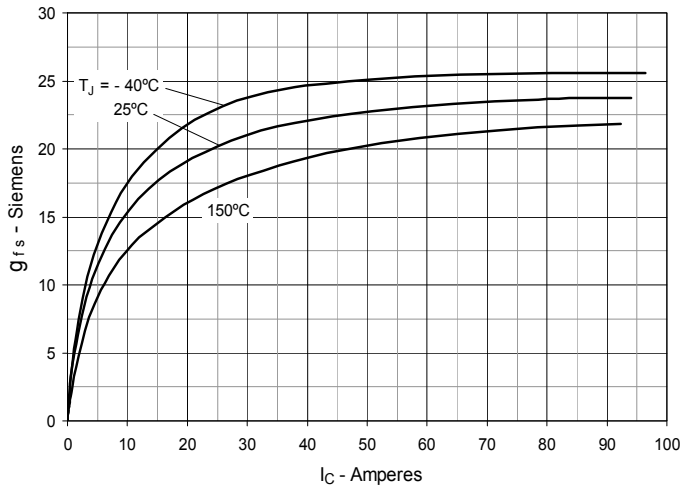

Fig. 8. Gate Charge

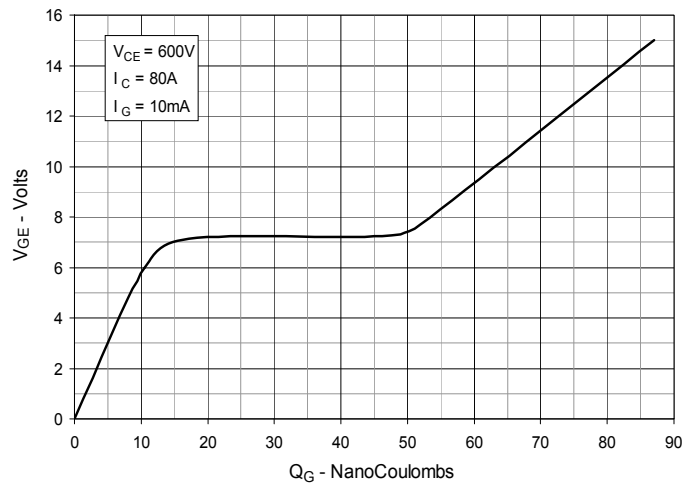

Fig. 9. Capacitance

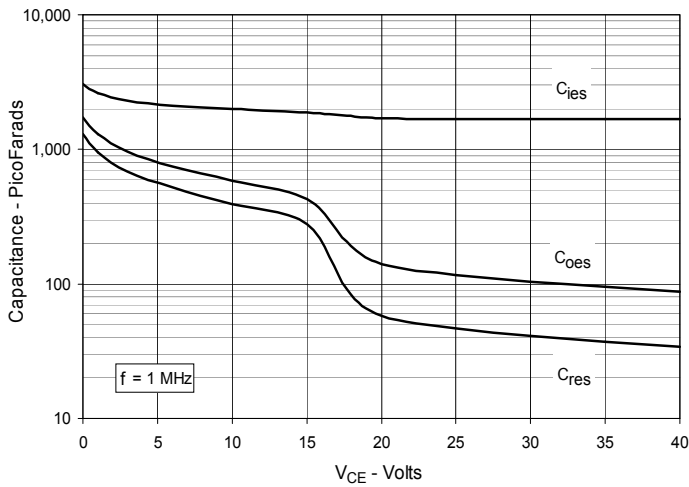

Fig. 10. Reverse-Bias Safe Operating Area

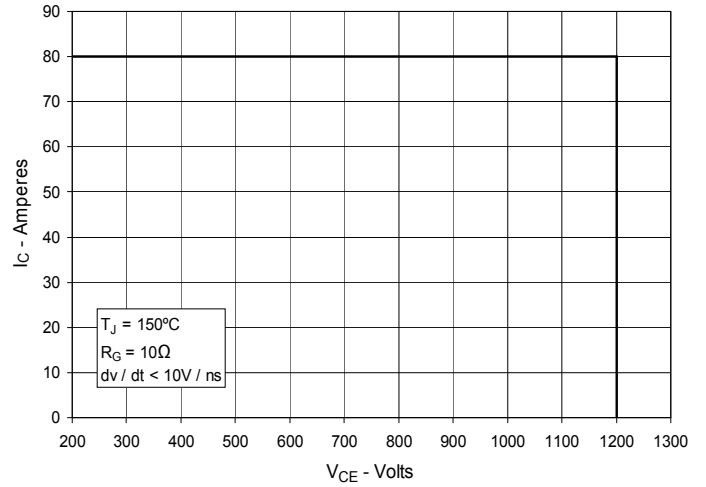

Fig. 11. Maximum Transient Thermal Impedance

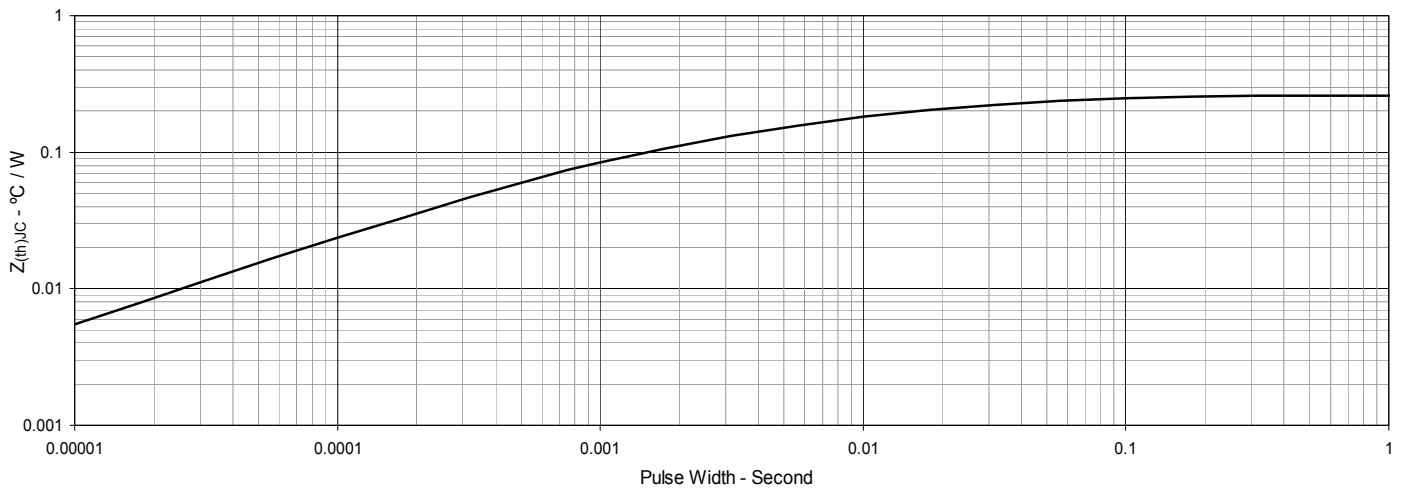

Fig. 12. Inductive Switching Energy Loss vs. Gate Resistance

Fig. 13. Inductive Switching Energy Loss vs. Collector Current

Fig. 14. Inductive Switching Energy Loss vs. Junction Temperature

Fig. 15. Inductive Turn-off Switching Times vs. Gate Resistance

Fig. 16. Inductive Turn-off Switching Times vs. Collector Current

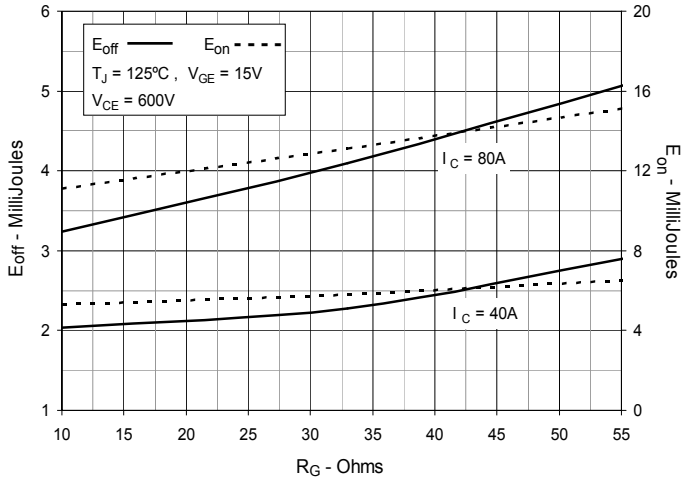
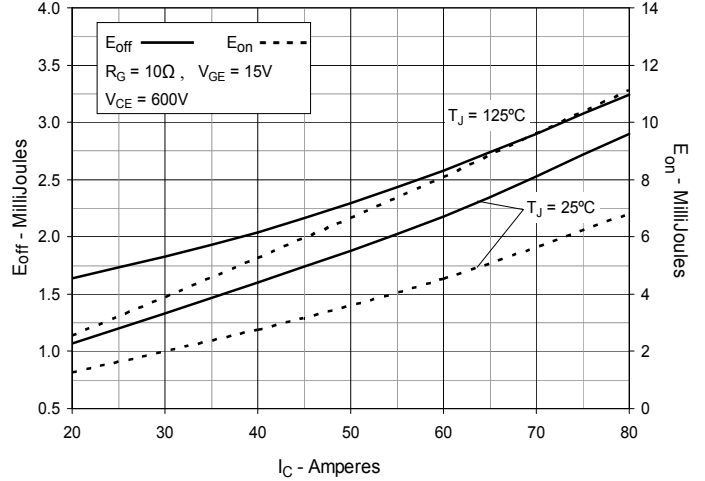
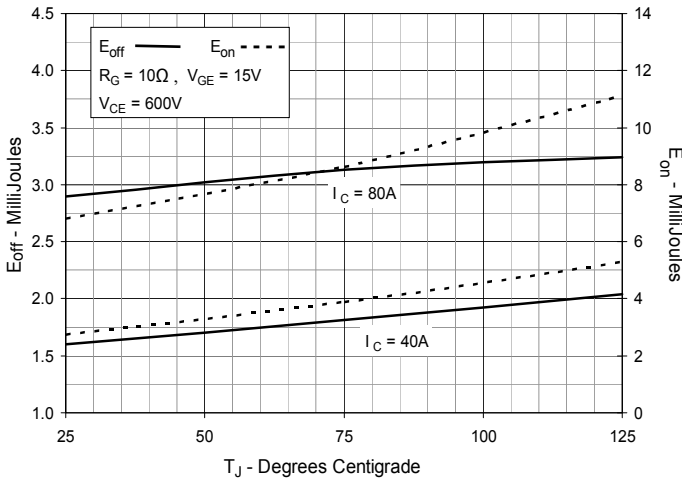
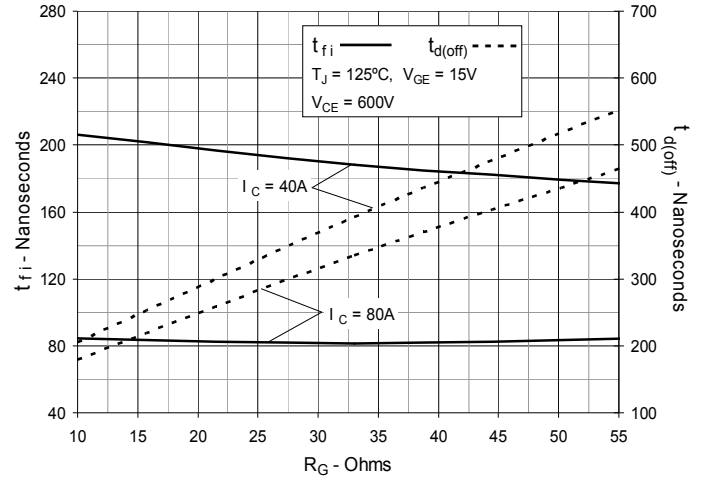
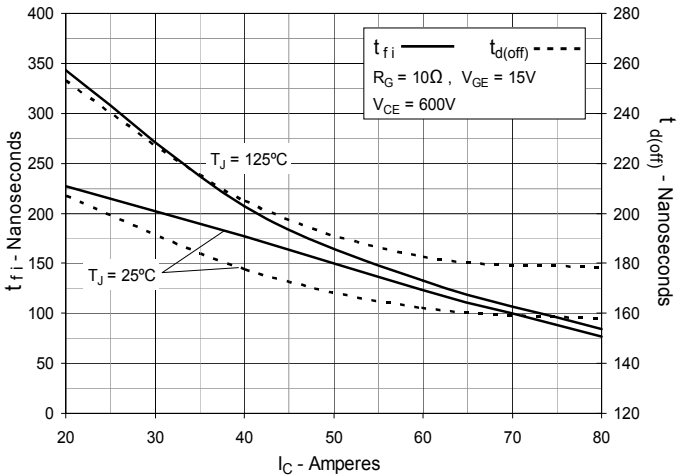
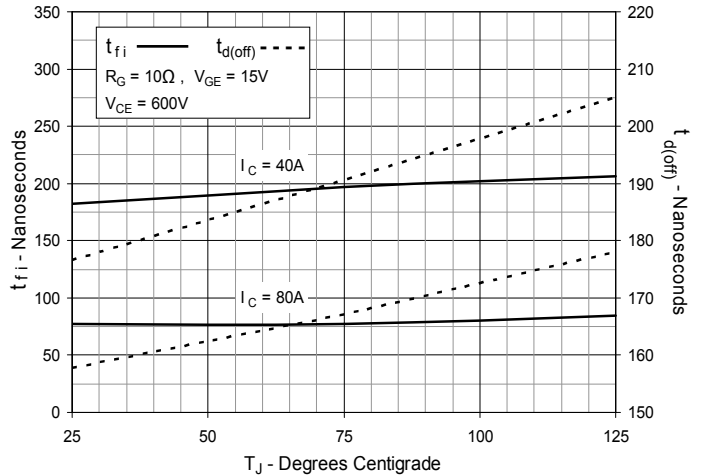
Fig. 17. Inductive Turn-off Switching Times vs. Junction Temperature

Fig. 18. Inductive Turn-on Switching Times vs. Gate Resistance

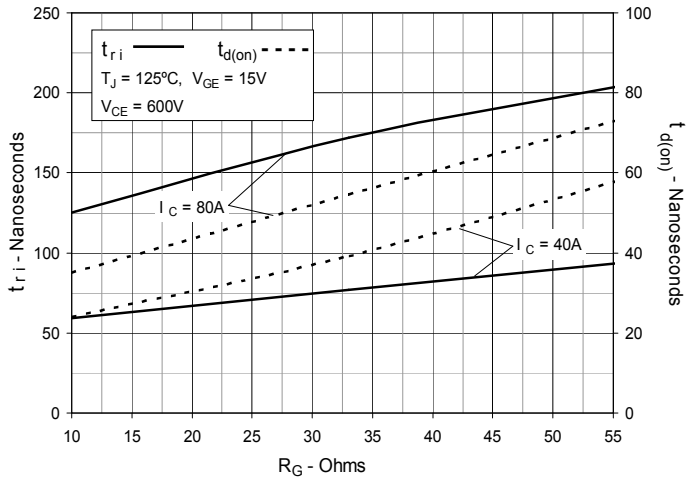

Fig. 19. Inductive Turn-on Switching Times vs. Collector Current

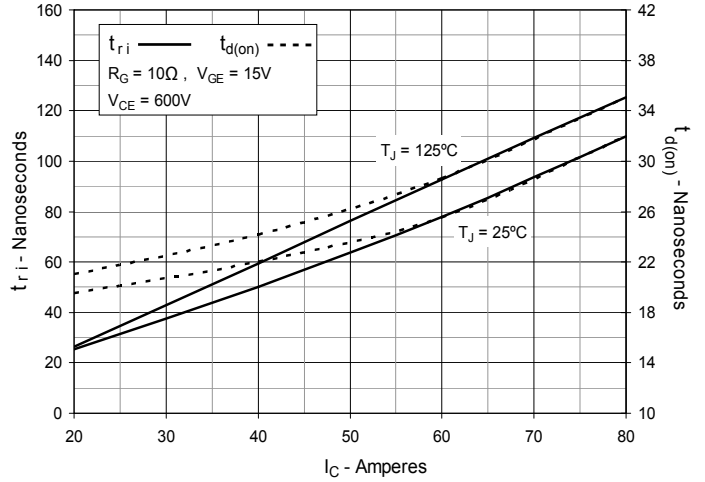
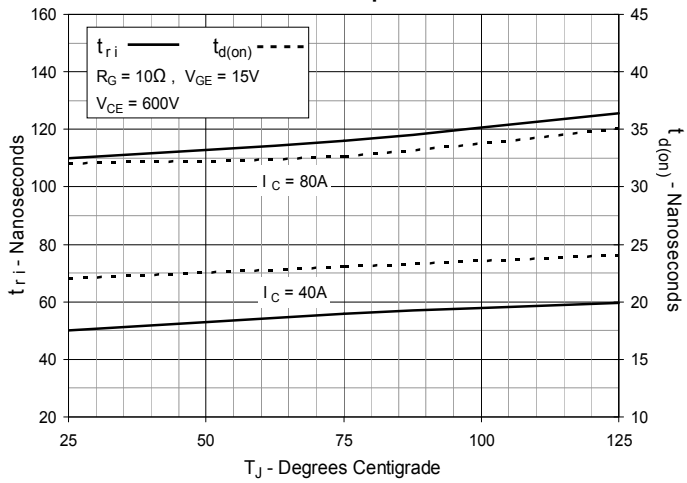

Fig. 20. Inductive Turn-on Switching Times vs. Junction Temperature



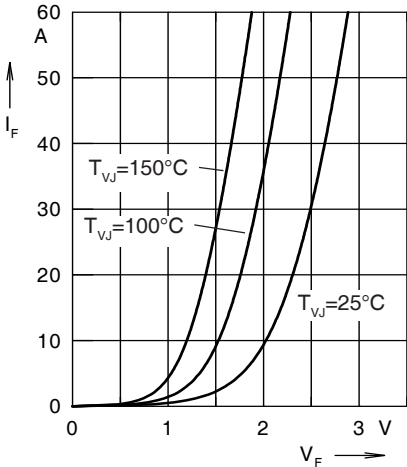

Fig. 21. Forward Current I_F Versus V_F

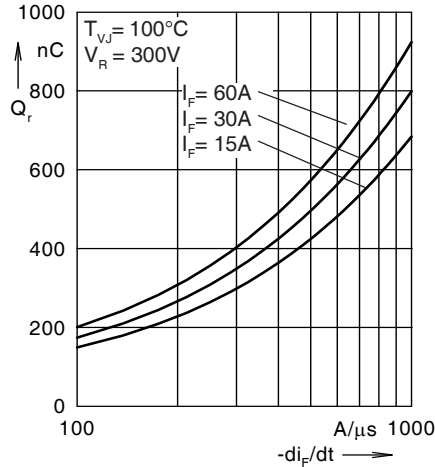

Fig. 22. Reverse Recovery Charge Q_r Versus $-di_F/dt$

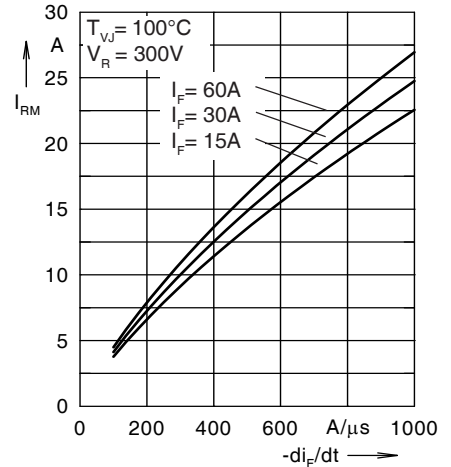

Fig. 23. Peak Reverse Current I_{RM} Versus $-di_F/dt$

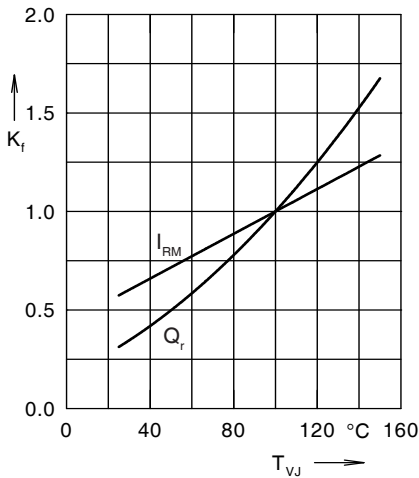

Fig. 24. Dynamic Parameters Q_r , I_{RM} Versus T_{VJ}

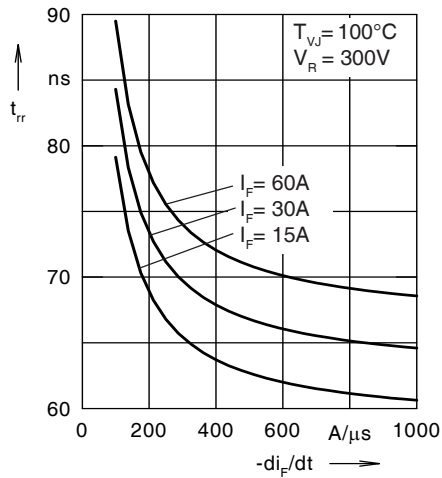

Fig. 25. Recovery Time t_{rr} Versus $-di_F/dt$

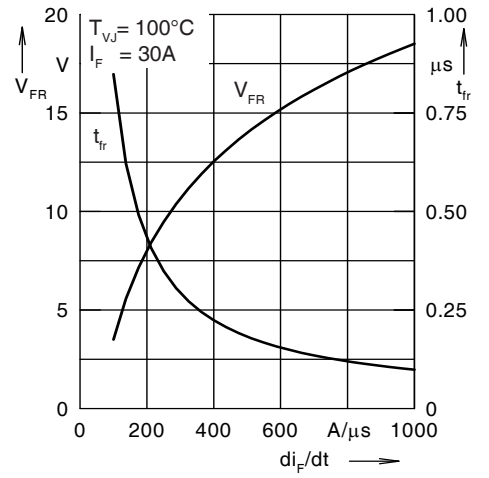

Fig. 26. Peak Forward Voltage V_{FR} and t_{fr} Versus di_F/dt

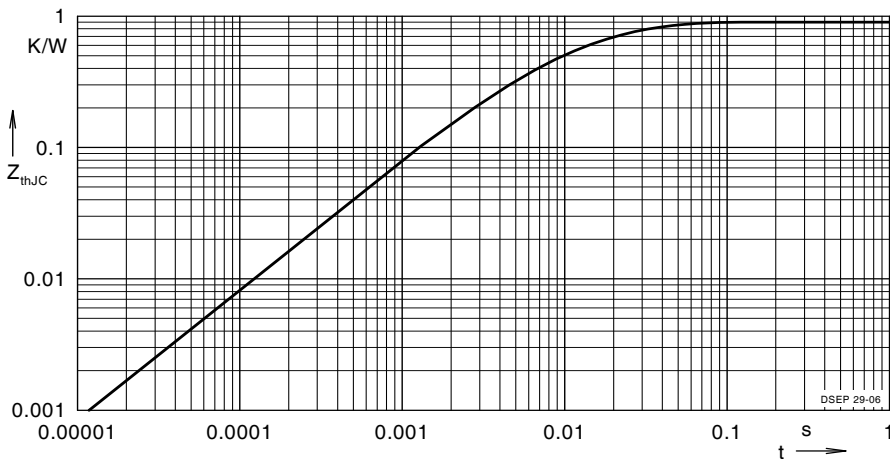

Fig. 27. Transient Thermal Resistance Junction to Case



Disclaimer Notice - Information furnished is believed to be accurate and reliable. However, users should independently evaluate the suitability of and test each product selected for their own applications. Littelfuse products are not designed for, and may not be used in, all applications. Read complete Disclaimer Notice at www.littelfuse.com/disclaimer-electronics.