

CSD01060

Silicon Carbide Schottky Diode

ZERO RECOVERY[®] RECTIFIER

V_{RRM}	=	600 V
$I_F (T_C=135^\circ\text{C})$	=	2 A
Q_c	=	3.3 nC

Features

- 600-Volt Schottky Rectifier
- Zero Reverse Recovery Current
- Zero Forward Recovery Voltage
- High-Frequency Operation
- Temperature-Independent Switching Behavior
- Extremely Fast Switching
- Positive Temperature Coefficient on V_F

Benefits

- Replace Bipolar with Unipolar Rectifiers
- Essentially No Switching Losses
- Higher Efficiency
- Reduction of Rectifier Heat Sink
- Parallel Devices Without Thermal Runaway

Applications

- Switch Mode Power Supplies
- Power Factor Correction
 - Typical PFC P_{out} : 100W-200W
- Motor Drives
 - Typical Power : 0.25HP-0.5HP

Package



TO-252-2

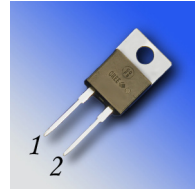

TO-220-2



Part Number	Package	Marking
CSD01060A	TO-220-2	CSD01060
CSD01060E	TO-252-2	CSD01060

Maximum Ratings ($T_C = 25^\circ\text{C}$ unless otherwise specified)

Symbol	Parameter	Value	Unit	Test Conditions	Note
V_{RRM}	Repetitive Peak Reverse Voltage	600	V		
V_{RSM}	Surge Peak Reverse Voltage	600	V		
V_{DC}	DC Blocking Voltage	600	V		
I_F	Continuous Forward Current	4 2 1	A	$T_C=25^\circ\text{C}$ $T_C=135^\circ\text{C}$ $T_C=158^\circ\text{C}$	
I_{FRM}	Repetitive Peak Forward Surge Current	7 5.5	A	$T_C=25^\circ\text{C}$, $t_p=10$ ms, Half Sine Wave $T_C=125^\circ\text{C}$, $t_p=10$ ms, Half Sine Wave	
I_{FSM}	Non-Repetitive Peak Forward Surge Current	9	A	$T_C=25^\circ\text{C}$, $t_p=1.5$ ms, Half Sine Wave	
I_{FSM}	Non-Repetitive Peak Forward Surge Current	32	A	$T_C=25^\circ\text{C}$, $t_p=10$ μs , Pulse	
P_{tot}	Power Dissipation	21.4 7.1	W	$T_C=25^\circ\text{C}$ $T_C=125^\circ\text{C}$	
T_J, T_{stg}	Operating Junction and Storage Temperature	-55 to +175	$^\circ\text{C}$		
	TO-220 Mounting Torque	1 8.8	Nm lbf-in	M3 Screw 6-32 Screw	

Electrical Characteristics

Symbol	Parameter	Typ.	Max.	Unit	Test Conditions	Note
V_F	Forward Voltage	1.6 2.0	1.8 2.4	V	$I_F = 1\text{ A}$ $T_J = 25^\circ\text{C}$ $I_F = 1\text{ A}$ $T_J = 175^\circ\text{C}$	
I_R	Reverse Current	20 40	100 500	μA	$V_R = 600\text{ V}$ $T_J = 25^\circ\text{C}$ $V_R = 600\text{ V}$ $T_J = 150^\circ\text{C}$	
Q_C	Total Capacitive Charge	3.3		nC	$V_R = 600\text{ V}$, $I_F = 1\text{ A}$ $di/dt = 500\text{ A}/\mu\text{s}$ $T_J = 25^\circ\text{C}$	
C	Total Capacitance	80 11 8.5		pF	$V_R = 0\text{ V}$, $T_J = 25^\circ\text{C}$, $f = 1\text{ MHz}$ $V_R = 200\text{ V}$, $T_J = 25^\circ\text{C}$, $f = 1\text{ MHz}$ $V_R = 400\text{ V}$, $T_J = 25^\circ\text{C}$, $f = 1\text{ MHz}$	

Note:

1. This is a majority carrier diode, so there is no reverse recovery charge.

Thermal Characteristics

Symbol	Parameter	Typ.	Unit
$R_{\theta JC}$	Thermal Resistance from Junction to Case	7	$^\circ\text{C}/\text{W}$
$R_{\theta JA}$	Thermal Resistance from Junction to Ambient	60	$^\circ\text{C}/\text{W}$

Typical Performance

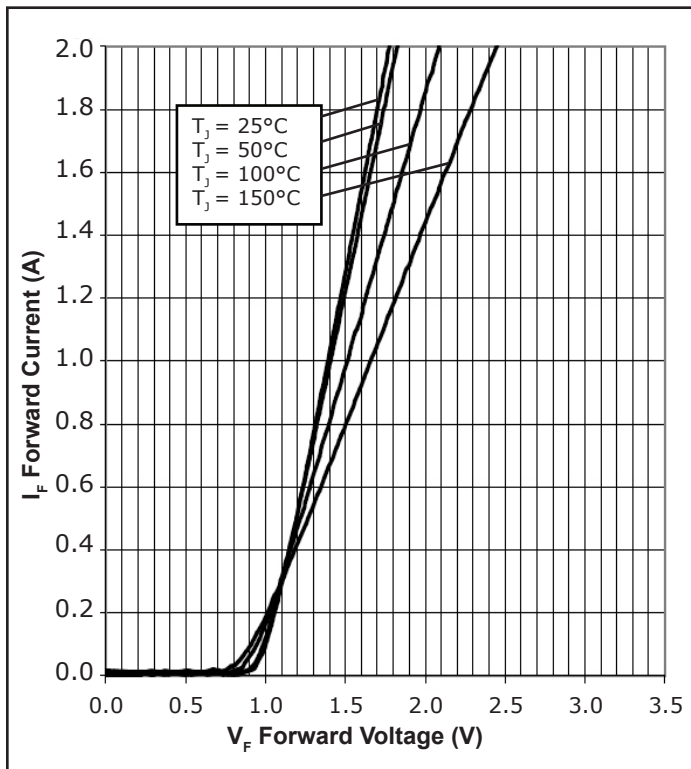

Figure 1. Forward Characteristics

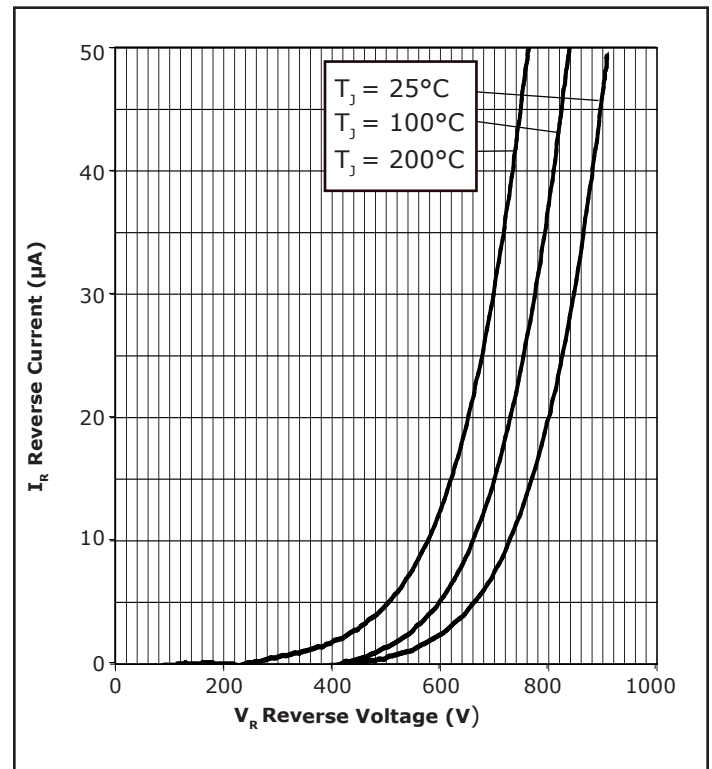

Figure 2. Reverse Characteristics

Typical Performance

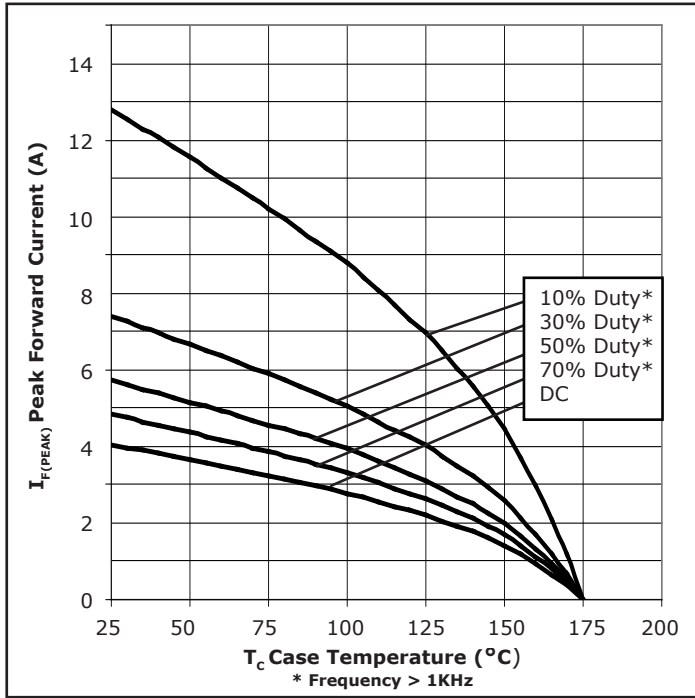

Figure 3. Current Derating

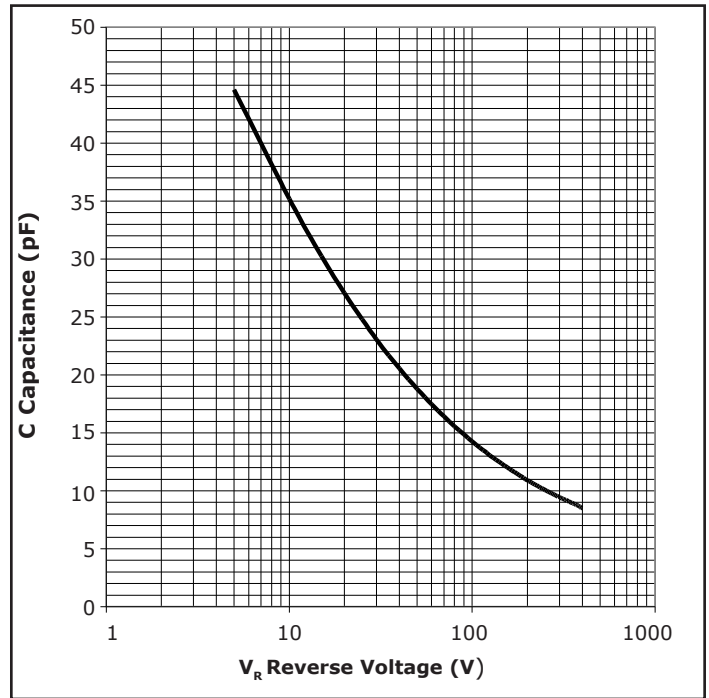

Figure 4. Capacitance vs. Reverse Voltage

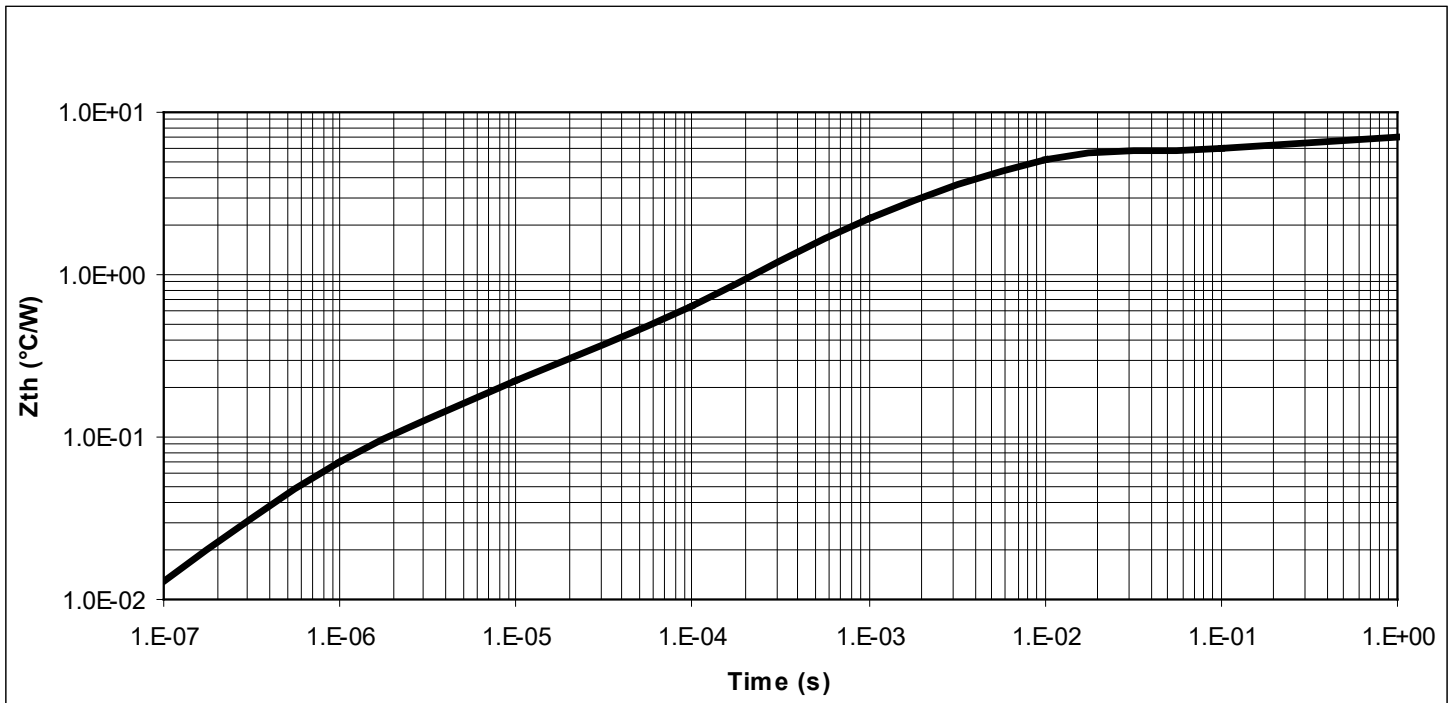

Figure 5. Transient Thermal Impedance

Typical Performance

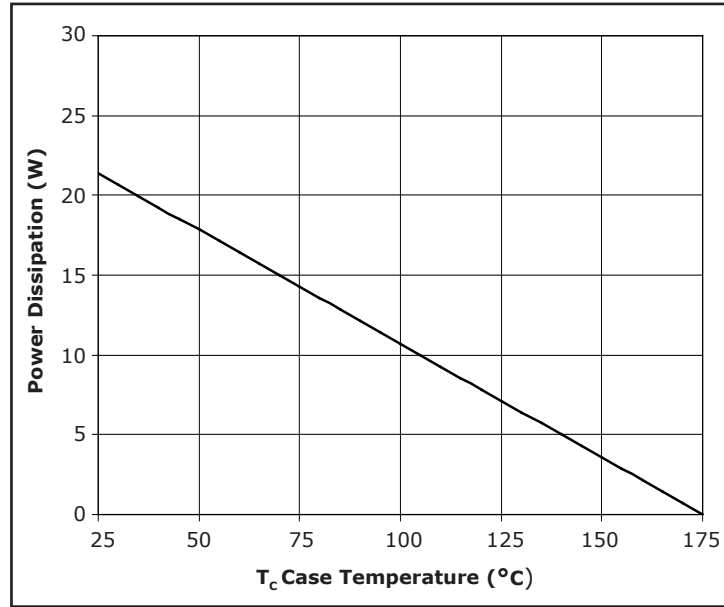
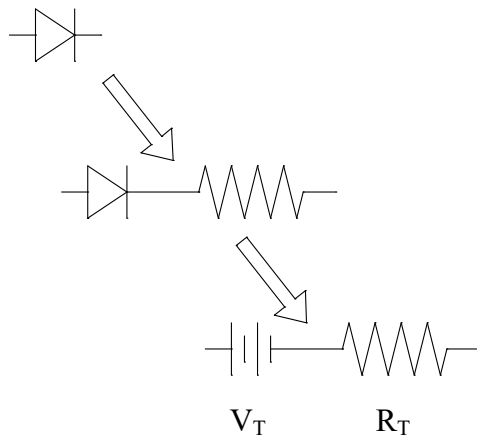

Figure 6. Power Derating

Diode Model



$$V_{fT} = V_T + I_f \cdot R_T$$

$$V_T = 0.94 + (T_j \cdot -1.2 \cdot 10^{-3})$$

$$R_T = 0.015 + (T_j \cdot 6.4 \cdot 10^{-3})$$

Note: T_j = Diode Junction Temperature In Degrees Celsius

Package Dimensions

Package TO-220-2

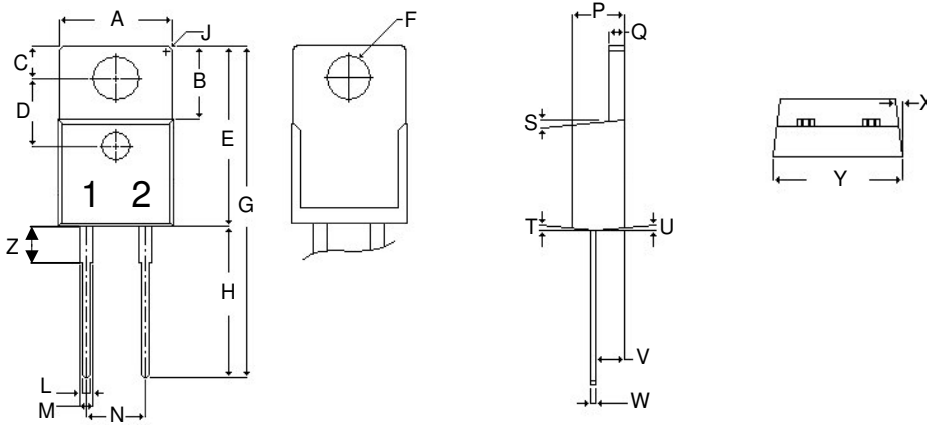

POS	Inches		Millimeters	
	Min	Max	Min	Max
A	.381	.410	9.677	10.414
B	.235	.255	5.969	6.477
C	.100	.120	2.540	3.048
D	.223	.337	5.664	8.560
E	.590	.615	14.986	15.621
F	.143	.153	3.632	3.886
G	1.105	1.147	28.067	29.134
H	.500	.550	12.700	13.970
J	R 0.197		R 0.197	
L	.025	.036	.635	.914
M	.045	.055	1.143	1.397
N	.195	.205	4.953	5.207
P	.165	.185	4.191	4.699
Q	.048	.054	1.219	1.372
S	3°	6°	3°	6°
T	3°	6°	3°	6°
U	3°	6°	3°	6°
V	.094	.110	2.388	2.794
W	.014	.025	.356	.635
X	3°	5.5°	3°	5.5°
Y	.385	.410	9.779	10.414
Z	.130	.150	3.302	3.810

NOTE:

1. Dimension L, M, W apply for Solder Dip Finish

Package Dimensions

Package TO-252-2

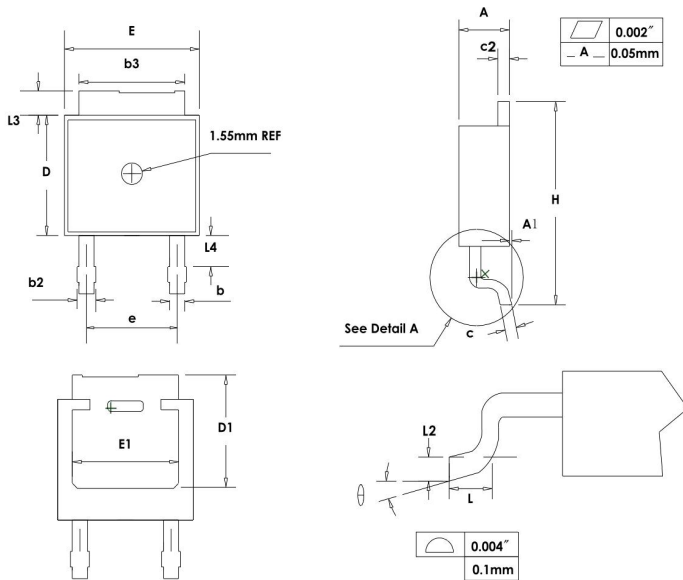

SYMBOL	MILLIMETERS	
	MIN	MAX
A	2.159	2.413
A1	0	0.13
b	0.64	0.89
b2	0.653	1.143
b3	5.004	5.6
c	0.457	0.61
c2	0.457	0.864
D	5.867	6.248
D1	5.21	-
E	6.35	6.73
E1	4.32	-
e	4.58 BSC	
H	9.65	10.414
L	1.106	1.78
L2	0.51 BSC	
L3	0.889	1.27
L4	0.64	1.01
θ	0°	8°

Recommended Solder Pad Layout

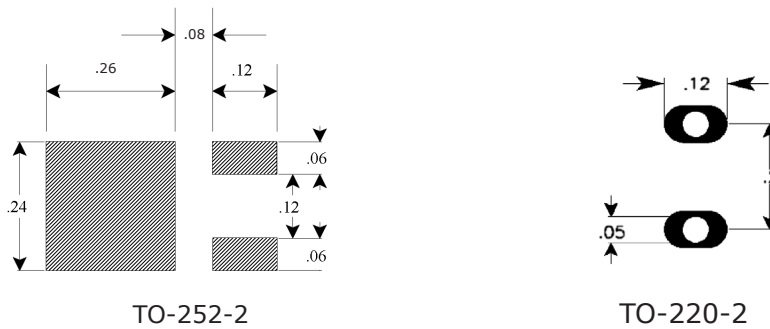

Part Number	Package	Marking
CSD01060A	TO-220-2	CSD01060
CSD01060E	TO-252-2	CSD01060

Note: Recommended soldering profiles can be found in the applications note here:
http://www.cree.com/power_app_notes/soldering



Notes

- RoHS Compliance**
 The levels of RoHS restricted materials in this product are below the maximum concentration values (also referred to as the threshold limits) permitted for such substances, or are used in an exempted application, in accordance with EU Directive 2011/65/EC (RoHS2), as implemented January 2, 2013. RoHS Declarations for this product can be obtained from your Cree representative or from the Product Documentation sections of www.cree.com.
- REACH Compliance**
 REACH substances of high concern (SVHCs) information is available for this product. Since the European Chemical Agency (ECHA) has published notice of their intent to frequently revise the SVHC listing for the foreseeable future, please contact a Cree representative to insure you get the most up-to-date REACH SVHC Declaration. REACH banned substance information (REACH Article 67) is also available upon request.
- This product has not been designed or tested for use in, and is not intended for use in, applications implanted into the human body nor in applications in which failure of the product could lead to death, personal injury or property damage, including but not limited to equipment used in the operation of nuclear facilities, life-support machines, cardiac defibrillators or similar emergency medical equipment, aircraft navigation or communication or control systems, air traffic control systems, or weapons systems.