

RO3103A-1

418.0 MHz SAW Resonator

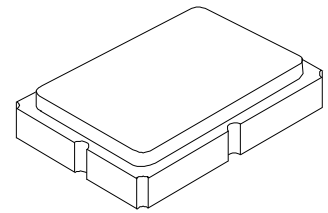

SM5035-4

- **Ideal for European 418.0 MHz Transmitters**
- **Very Low Series Resistance**
- **Quartz Stability**
- **Surface-Mount Ceramic Case**
- **Complies with Directive 2002/95/EC (RoHS)**
- **Tape and Reel Standard per ANSI/EIA-481**
- **Moisture Sensitivity Level: 1**
- **AEC-Q200 Qualified**

The RO3103A-1 is a true one-port, surface-acoustic-wave (SAW) resonator in a surface-mount, ceramic case. It provides reliable, fundamental-mode, quartz frequency stabilization of fixed-frequency transmitters operating at 418 MHz. This SAW is designed specifically for remote-control and wireless security transmitters operating in Europe under ETSI I-ETS 300 220 and in Germany under FTZ 17 TR 2100.

Absolute Maximum Ratings

Rating	Value	Units
CW RF Power Dissipation (See: Typical Test Circuit)	+0	dBm
DC voltage Between Terminals (Observe ESD Precautions)	±30	VDC
Case Temperature	-40 to +125	°C
Soldering Temperature (10 seconds / 5 cycles max.)	260	°C

Characteristic		Sym	Notes	Minimum	Typical	Maximum	Units
Center Frequency (+25 °C)	Absolute Frequency	f_C		417.950		418.05	MHz
	Tolerance from 418.00 MHz	Δf_C				±50	kHz
Insertion Loss		IL			1.5	2.0	dB
Quality Factor	Unloaded Q	Q_U			9700		
	50 Ω Loaded Q	Q_L			1300		
Temperature Stability	Turnover Temperature	T_O		10	25	40	°C
	Turnover Frequency	f_O			f_C		
	Frequency Temperature Coefficient	FTC			0.032		ppm/°C ²
Frequency Aging	Absolute Value during the First Year	f_A			≤10		ppm/yr
DC Insulation Resistance between Any Two Terminals				1.0			M Ω
RF Equivalent RLC Model	Motional Resistance	R_M			15		Ω
	Motional Inductance	L_M			57		μ H
	Motional Capacitance	C_M			2.5		fF
	Shunt Static Capacitance	C_O		2.1	2.4	2.7	pF
Test Fixture Shunt Inductance		L_{TEST}			60		nH
Lid Symbolization (YY = Year, WW = Week, S = Shift)	751, YYWWS						



CAUTION: Electrostatic Sensitive Device. Observe precautions for handling.

NOTES:

1. The design, manufacturing process, and specifications of this device are subject to change.
2. US or International patents may apply.
3. RoHS compliant from the first date of manufacture.

Electrical Connections

The SAW resonator is bidirectional and may be installed with either orientation. The two terminals are interchangeable and unnumbered. The callout NC indicates no internal connection. The NC pads assist with mechanical positioning and stability. External grounding of the NC pads is recommended to help reduce parasitic capacitance in the circuit.

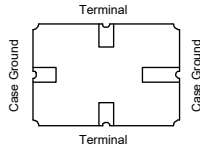

Typical Test Circuit

The test circuit inductor, L_{TEST} , is tuned to resonate with the static capacitance, C_O , at F_C .

ELECTRICAL TEST

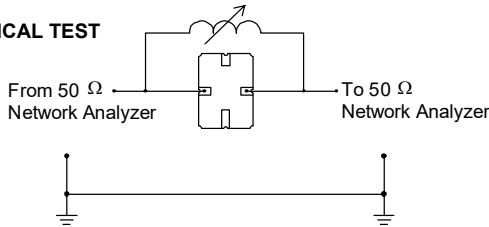

POWER TEST

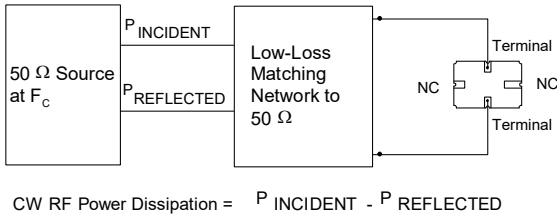

Typical Application Circuits

Typical Low-Power Transmitter Application

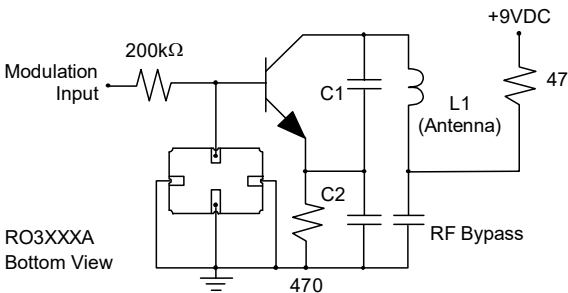

Typical Local Oscillator Applications

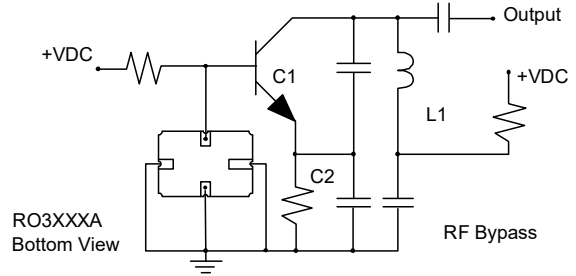

Equivalent LC Model

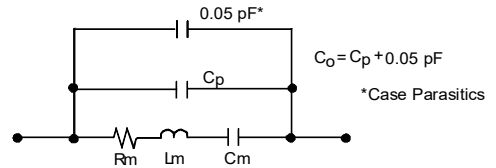

Temperature Characteristics

The curve shown on the right accounts for resonator contribution only and does not include LC component temperature contributions.

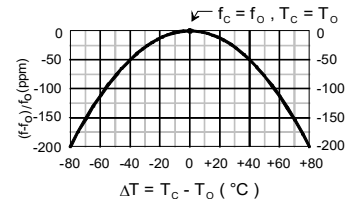

Typical Circuit Board Land Pattern

The circuit board land pattern shown below is one possible design. The optimum land pattern is dependent on the circuit board assembly process which varies by manufacturer. The distance between adjacent land edges should be at a maximum to minimize parasitic capacitance. Trace lengths from terminal lands to other components should be short and wide to minimize parasitic series inductances.

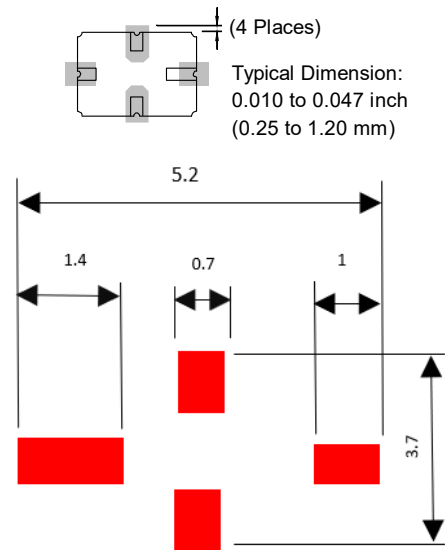

PCB Footprint

Case Design

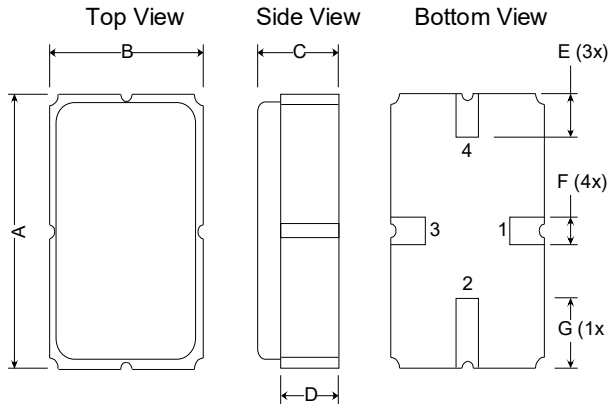

Dimensions	Millimeters			Inches		
	Min	Nom	Max	Min	Nom	Max
A	4.87	5.00	5.13	0.191	0.196	0.201
B	3.37	3.50	3.63	0.132	0.137	0.142
C	1.45	1.53	1.60	0.057	0.060	0.062
D	1.35	1.43	1.50	0.040	0.057	0.059
E	0.67	0.80	0.93	0.026	0.031	0.036
F	0.37	0.50	0.63	0.014	0.019	0.024
G	1.07	1.20	1.33	0.042	0.047	0.052

Recommended Reflow Profile

1. Preheating shall be fixed at 150~180°C for 60~90 seconds.
2. Ascending time to preheating temperature 150°C shall be 30 seconds min.
3. Heating shall be fixed at 220°C for 50~80 seconds and at 260°C +0/-5°C peak (10 seconds).
4. Time: 5 times maximum.

