

EZO-RGBTM

Embedded Color Sensor

Reads

RGB (24-bit)

CIE (xyY)

LUX (0 – 65535)

Features

onboard LEDs
programmable color matching

Connector

5 lead data cable

Response time

1 reading per 400 milliseconds

Sensing area

15° half angle

Cable length

1 meter

Water resistant/dust proof

IP67

Data protocol

UART & I²C

Default I²C address

112 (0x70)

Data format

ASCII

Operating voltage

3.3V – 5V

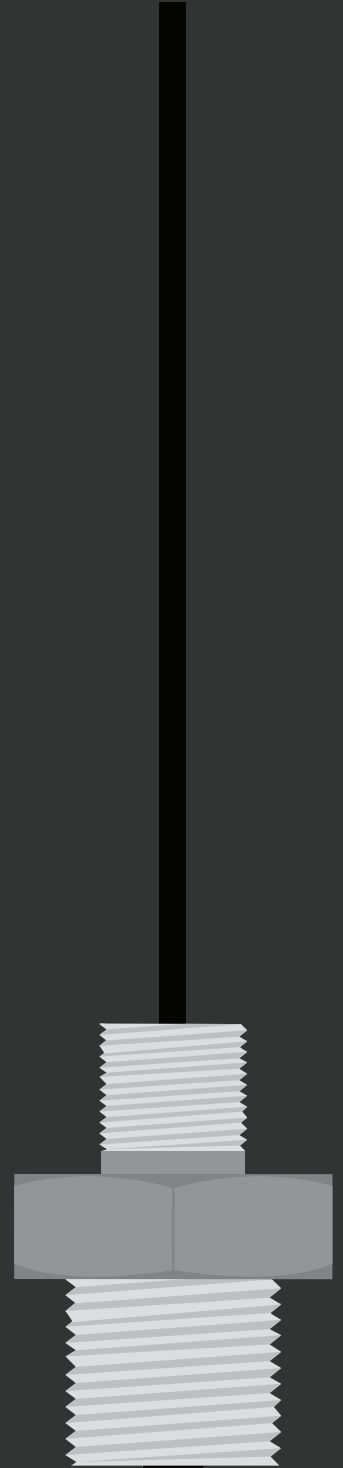

New Feature

The EZO-RGB™ Embedded Color Sensor is now IP67 waterproof – up to 1 meter

Strong Epoxy coating on lens

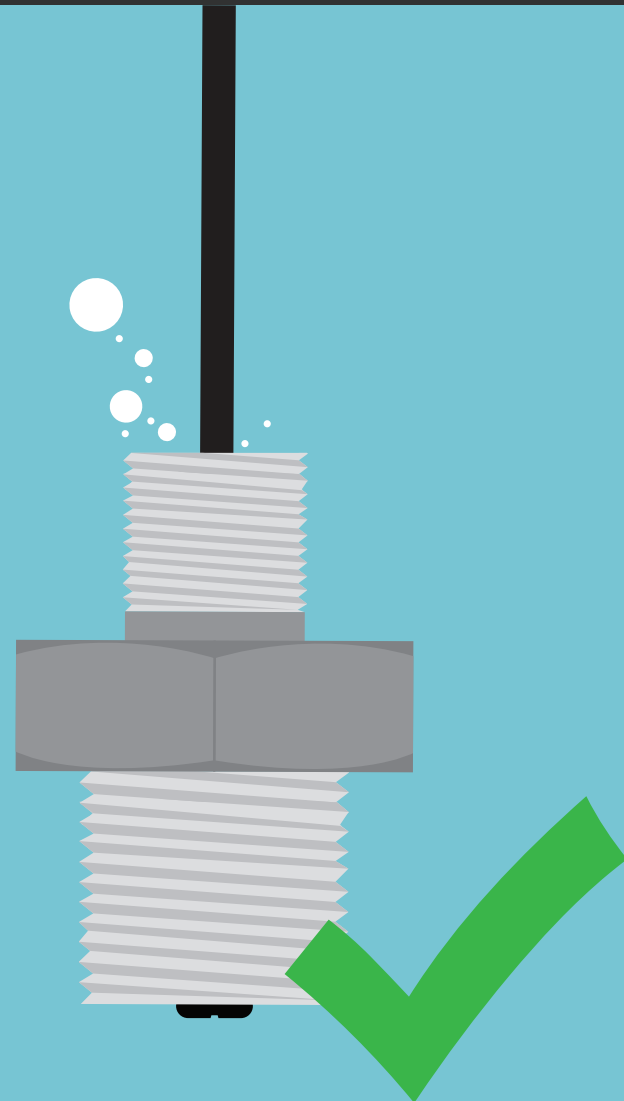
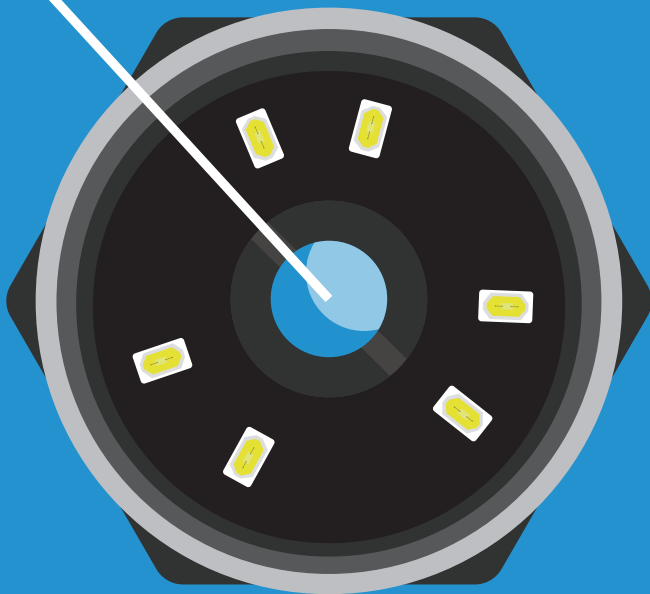

All EZO-RGB™ Embedded Color Sensors purchased after November 13th 2020, will be IP67 waterproof.

Caution

At full power the onboard LEDs are VERY bright.
Do not look directly at the light without eye protection!

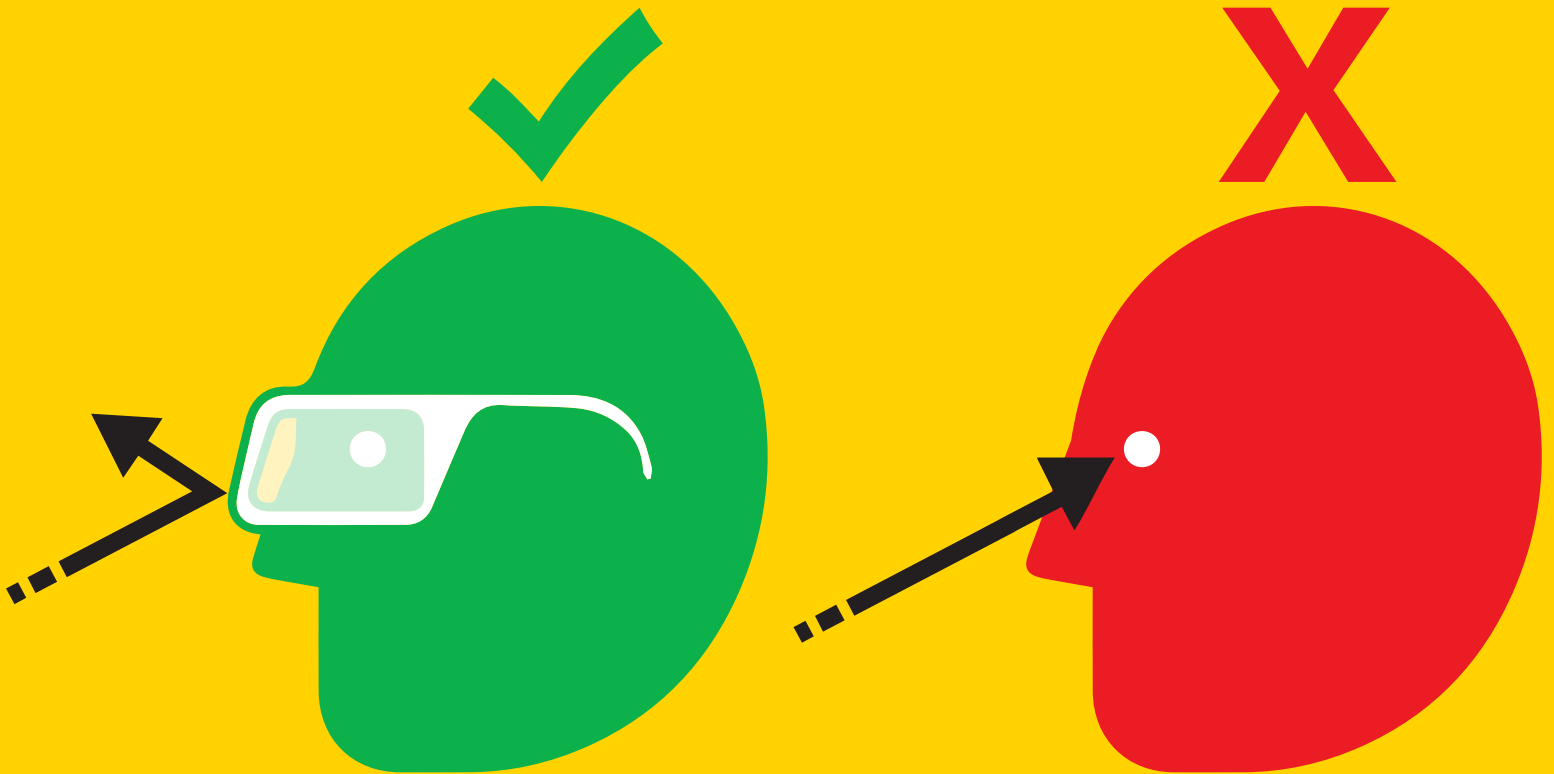

Minimum brightness = ~**400 Lux**

Maximum brightness = ~**40,000 Lux** at 5V (**36,000 Lux** at 3.3V)

Table of contents

Physical properties	5	Data output	12
Sensor properties	6	CIE 1931 color space	12
Target LED properties	7	Lux	13
Pin out	8	Color matching	14
Performance testing	9	Default state	15
Sensitivity	10	Available data protocol	16
Calibration theory	11		

UART

UART mode	18
Receiving data from device	19
Sending commands to device	20
LED color definition	21
UART quick command page	22
Target LED control	23
Indicator LED control	24
Find	25
Continuous mode	26
Single reading mode	27
Calibration	28
Automatic color matching	29
Gamma correction	30
Enable/disable parameters	31
Naming device	32
Device information	33
Response codes	34
Reading device status	35
Sleep mode/low power	36
Change baud rate	37
Protocol lock	38
Factory reset	39
Change to I ² C mode	40
Manual switching to I ² C	41

I²C

I ² C mode	43
Sending commands	44
Requesting data	45
Response codes	46
Processing delay	46
LED color definition	47
I²C quick command page	48
Target LED control	49
Indicator LED control	50
Find	51
Taking reading	52
Calibration	53
Gamma correction	54
Enable/disable parameters	55
Naming device	56
Device information	57
Reading device status	58
Sleep mode/low power	59
Protocol lock	60
I ² C address change	61
Factory reset	62
Change to UART mode	63
Manual switching to UART	64

Datasheet change log	65
Firmware updates	66
Warranty	67

Physical properties

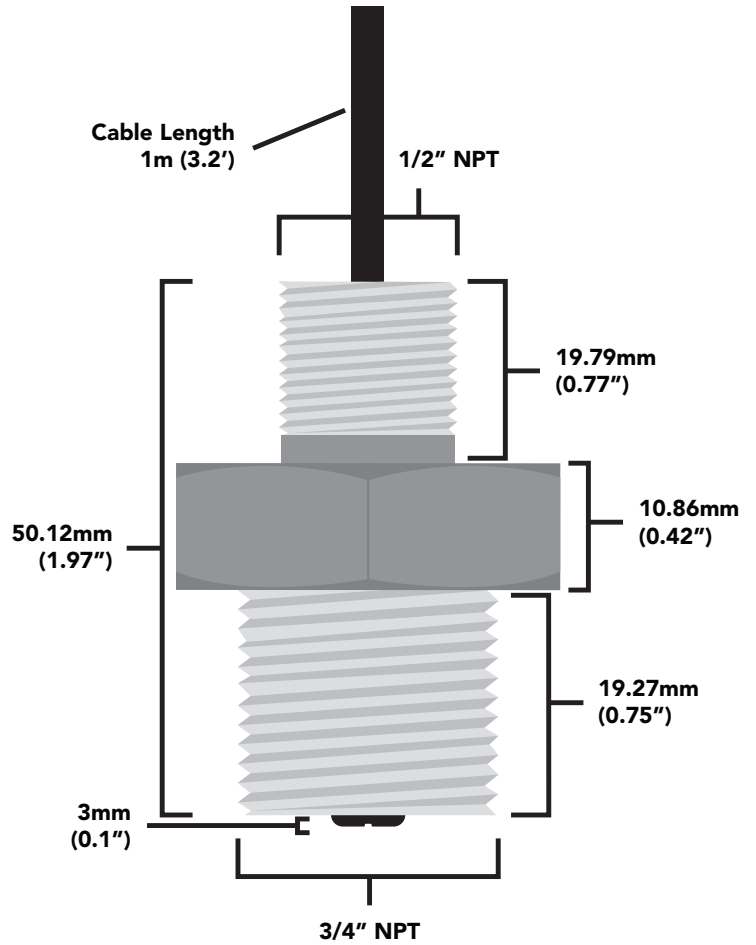
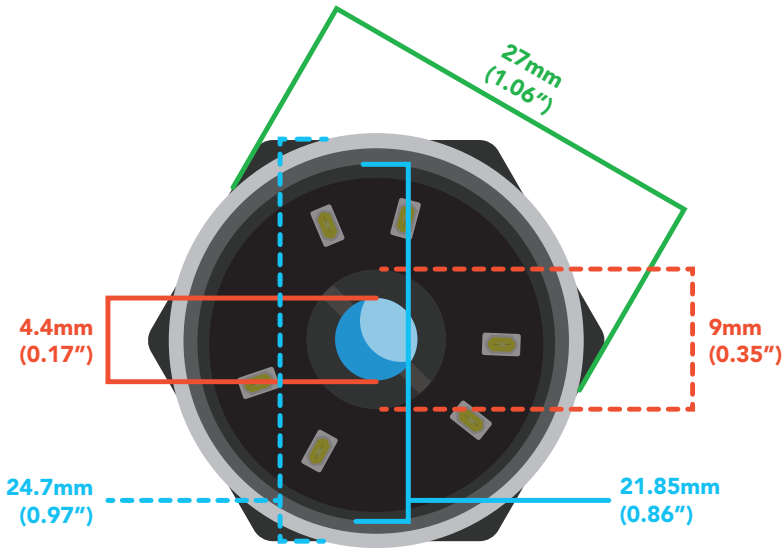

Weight 145g

Body 316 Stainless Steel



Front

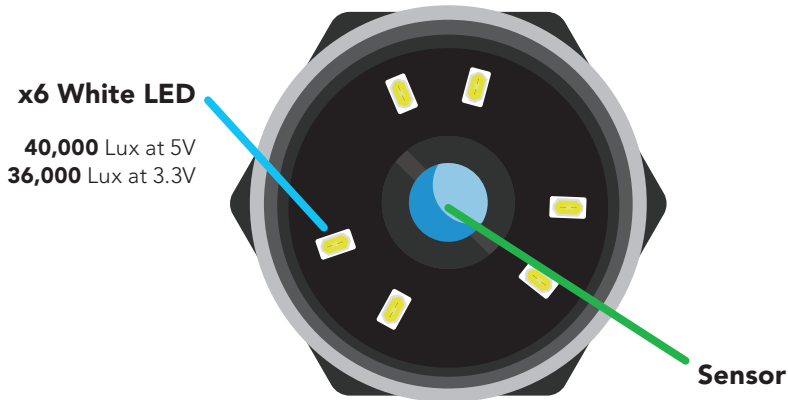

Back

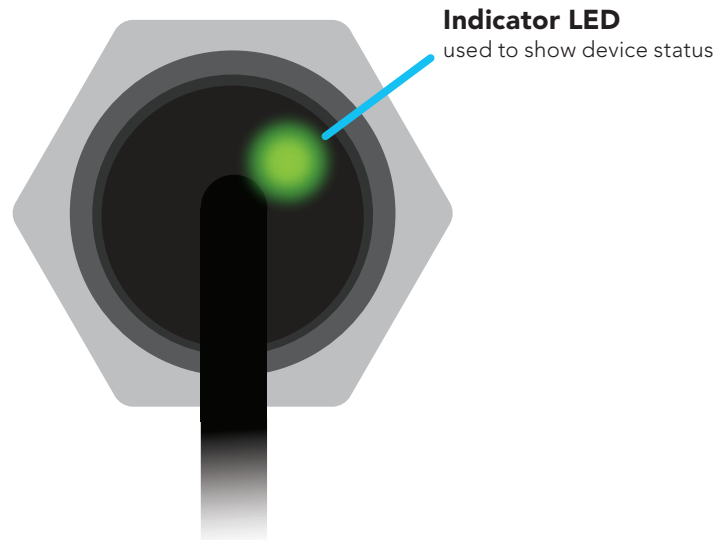

Sensor properties

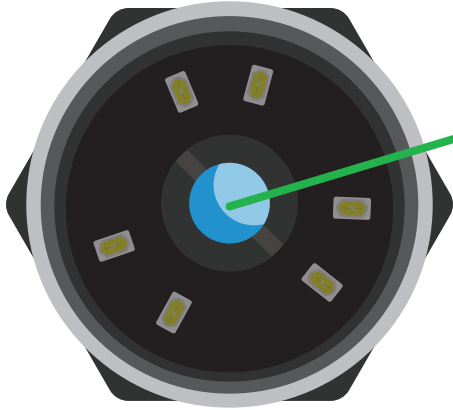

Sensor

The sensor detects colored light in the red, green and blue spectrum. It is least sensitive to blue light and most sensitive to red light.

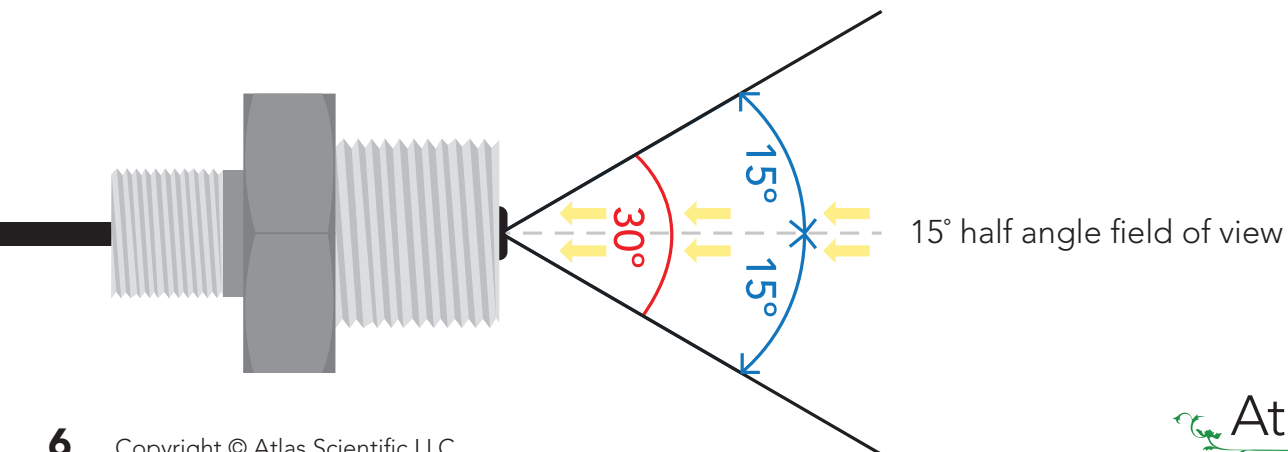
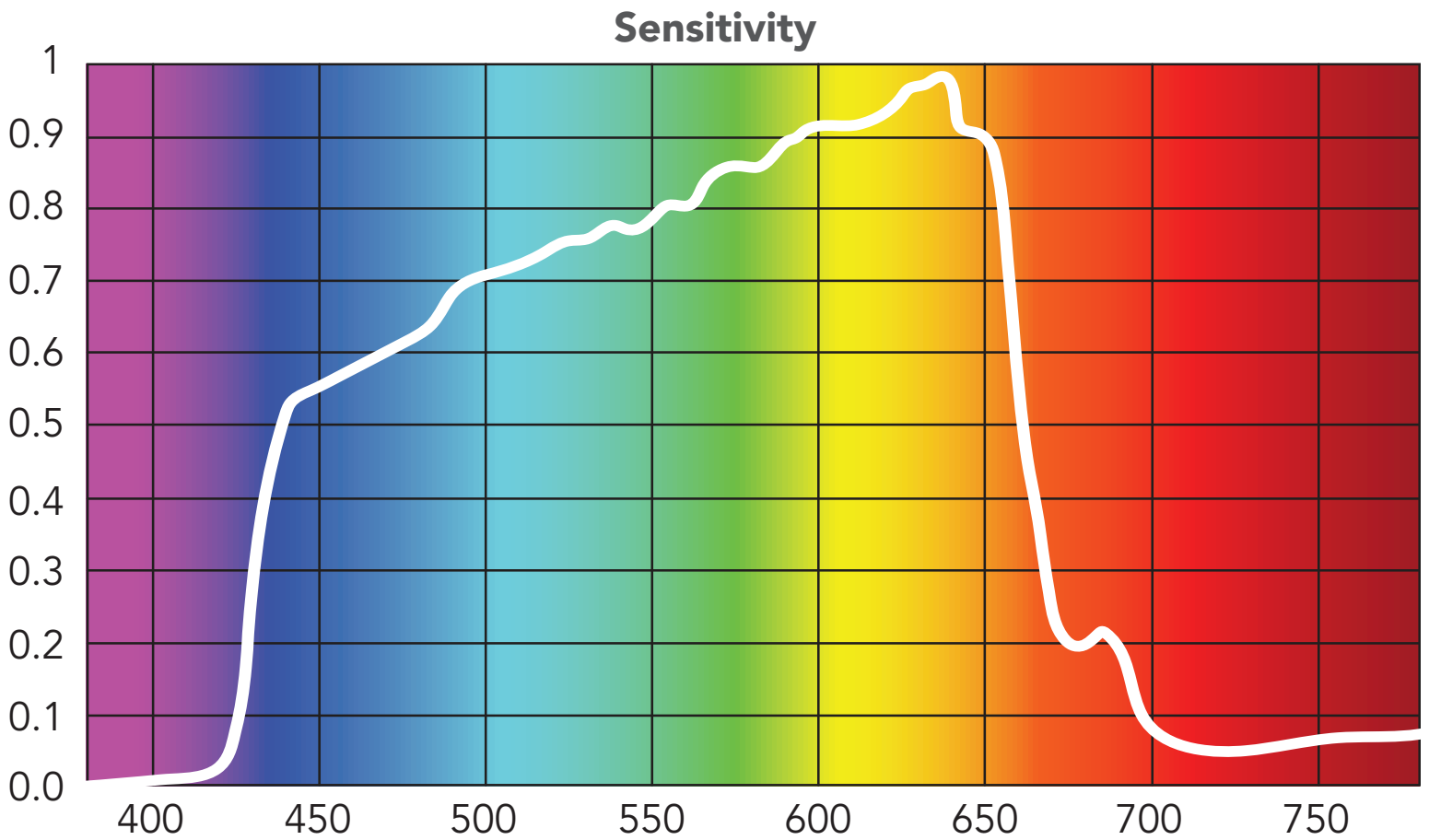

Target LED properties



x6 White LED (5000K color temperature)

The spectrum output by the six onboard target LEDs is strongest in the blue spectrum and weakest in the red spectrum. This is the opposite of the color sensors sensitivity giving it the best possible color sensing performance.

Target LED brightness

Minimum ~400 Lux

Maximum ~40,000 Lux

Onboard LEDs output spectrum

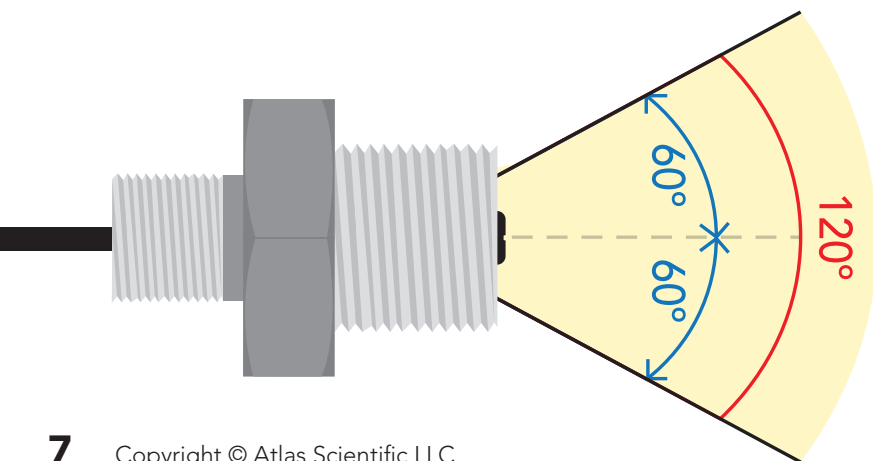
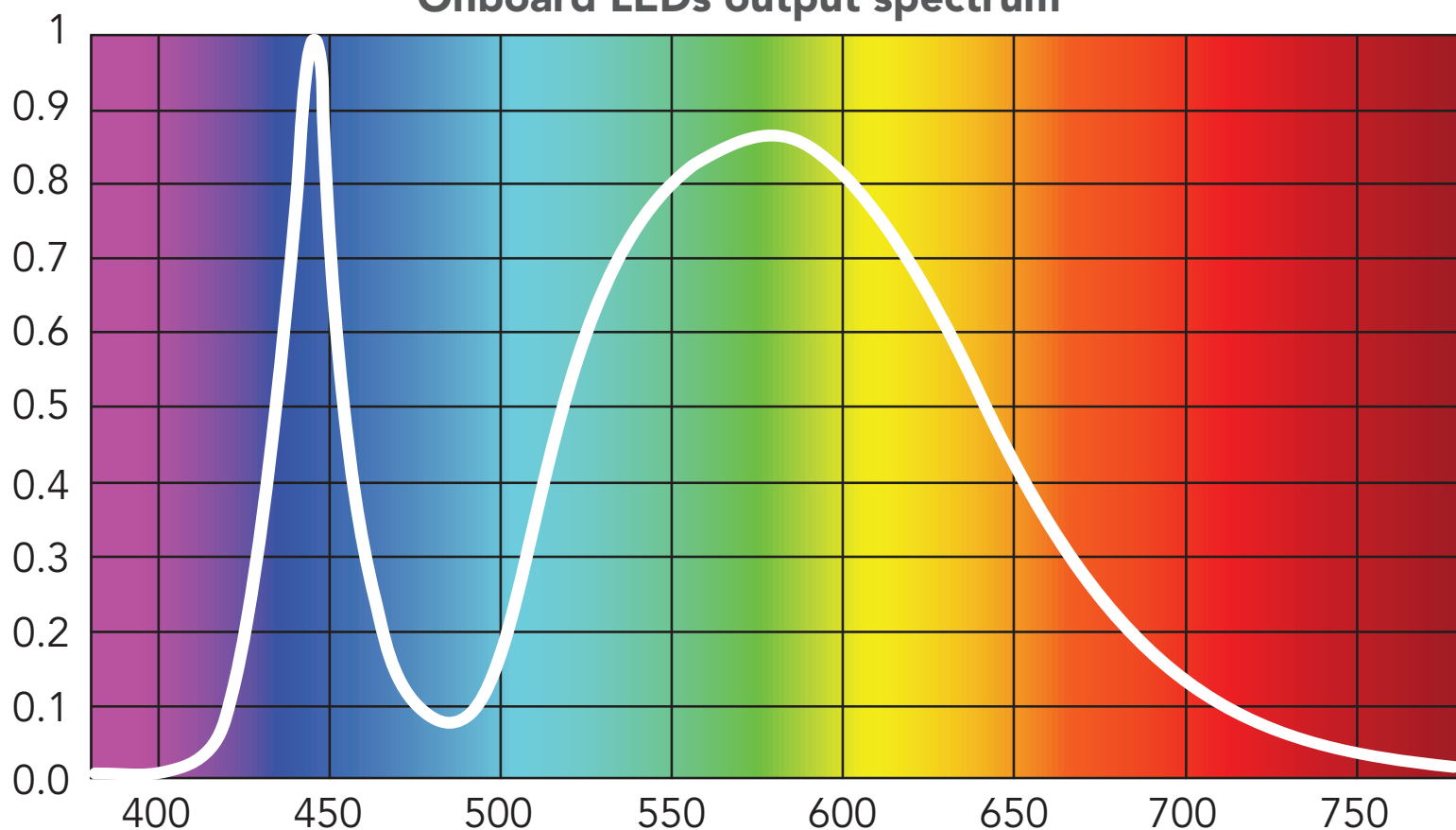

120° angle of illumination

Pin out

Data and power cable pinout

White – RX/SCL
 Green – TX/SDA
 Black – GND
 Red – VCC
 Blue – INT



The interrupt pin will change its state when a color match has been detected.

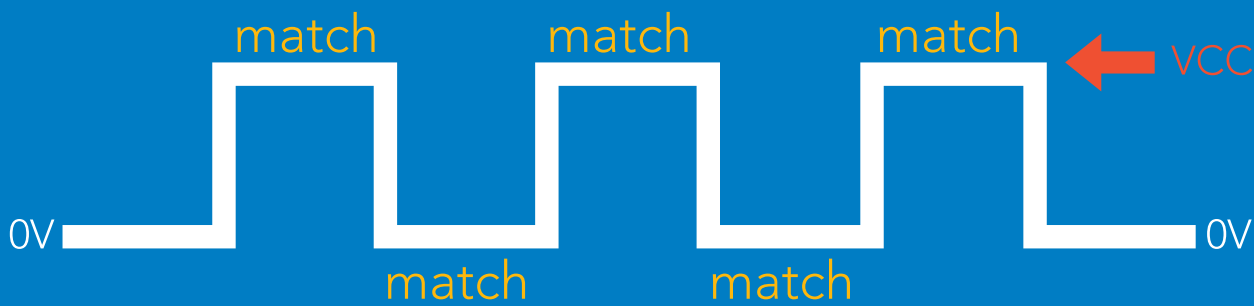

If unused leave **INT** floating. Do not connect **INT** to **VCC** or **GND**.

See page [29](#) to enable automatic color matching in UART mode.

Power consumption

	LED	MAX	SLEEP
5V	ON 100%	275 mA	
	ON 1%	15 mA	0.40 mA
	OFF	13 mA	
3.3V	ON 100%	100 mA	
	ON 1%	15 mA	0.14 mA
	OFF	12 mA	

Absolute max ratings

Parameter	MIN	TYP	MAX
Storage temperature	-65 °C		125 °C
Operational temperature	-40 °C	25 °C	85 °C
VCC	3.3V	3.3V	5.5V
Pressure			1379kPa (200 PSI)

Performance testing

Color Sample	Kodak™ Gray Card Plus
Distance	2.5cm
On-board LEDs	100% power
VCC	5V

The color readings were displayed using the free software on the Atlas Scientific™ website located [HERE](#).

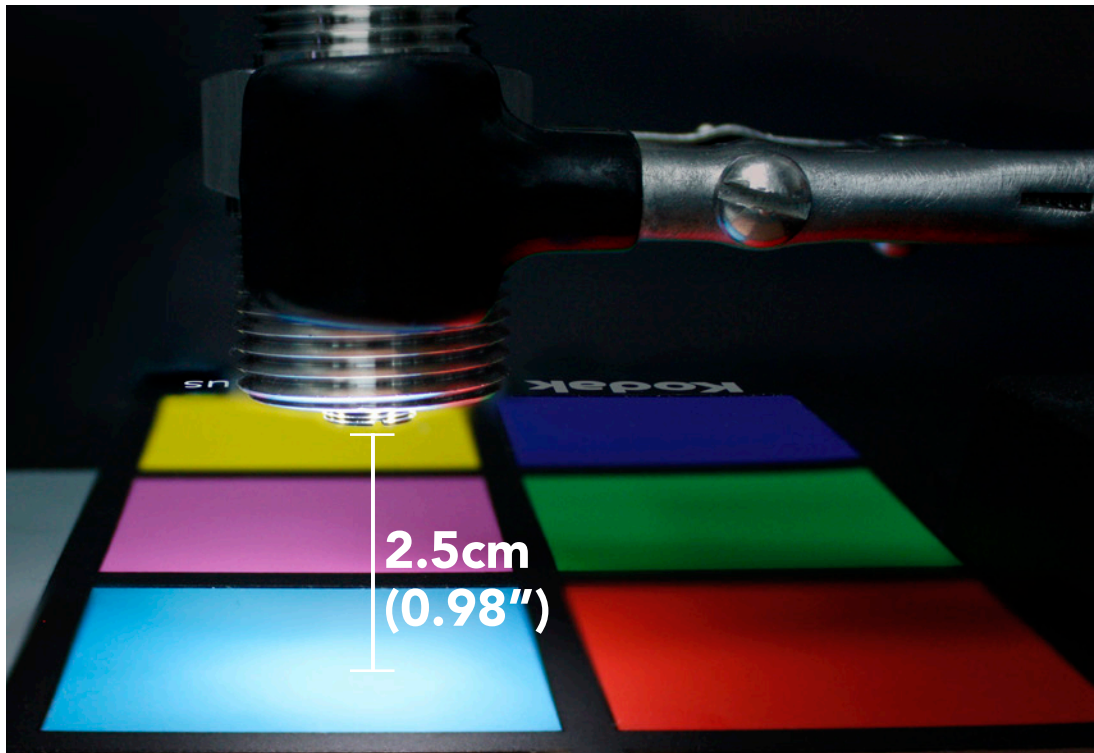

Kodak™ Gray Card Plus

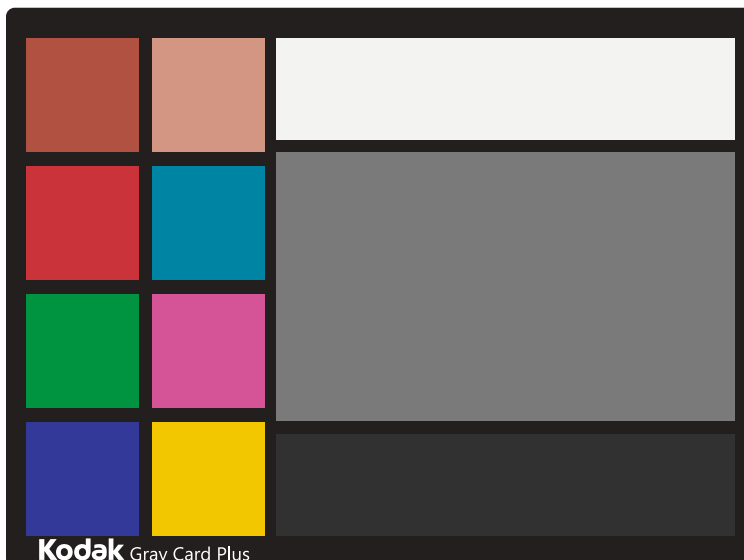

Color output from the EZO-RGB™

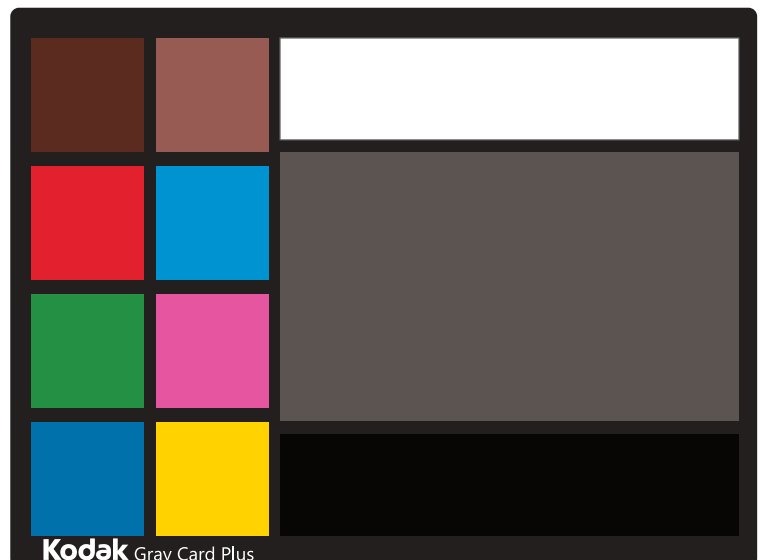

Sensitivity

As the EZO-RGB™ color sensor is placed further away from the target object, its ability to detect color is diminished. At distances greater than **45cm** most colors become varying shades of gray.

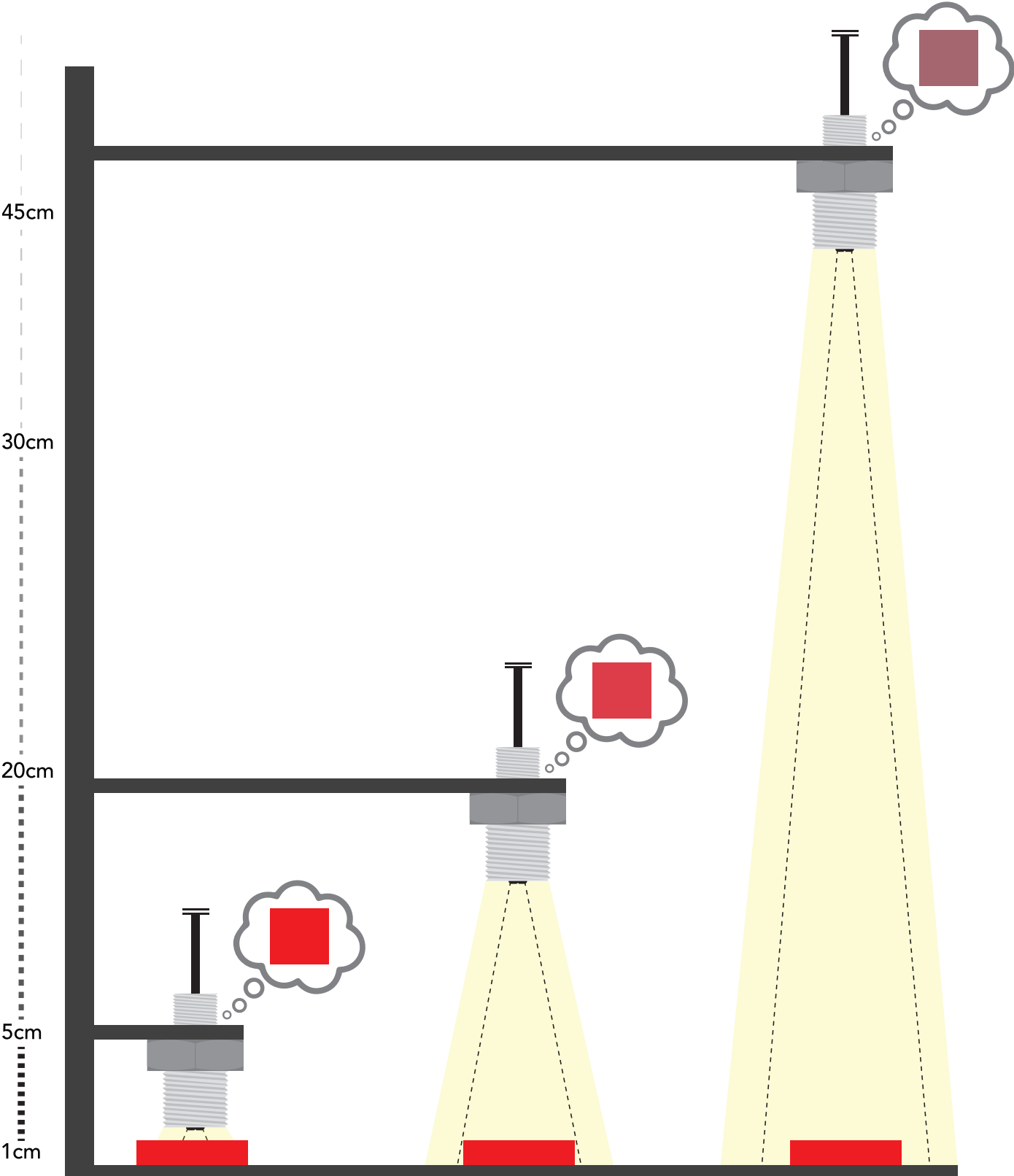

Calibration theory

The EZO-RGB™ color sensor is designed to be calibrated to a white object at the maximum brightness the object will be viewed under. In order to get the best results Atlas Scientific strongly recommends that the sensor is mounted into a fixed location. Holding the sensor in your hand during calibration will decrease performance.

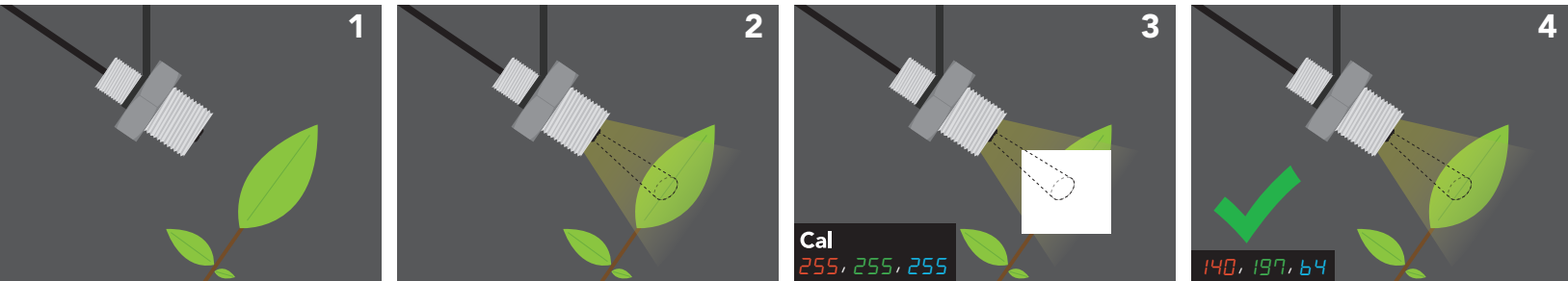

1. Embed the EZO-RGB™ color sensor into its intended use location.
2. Set LED brightness to the desired level.
3. Place a white object in front of the target object and issue the calibration command "Cal".
4. A single color reading will be taken and the device will be fully calibrated.

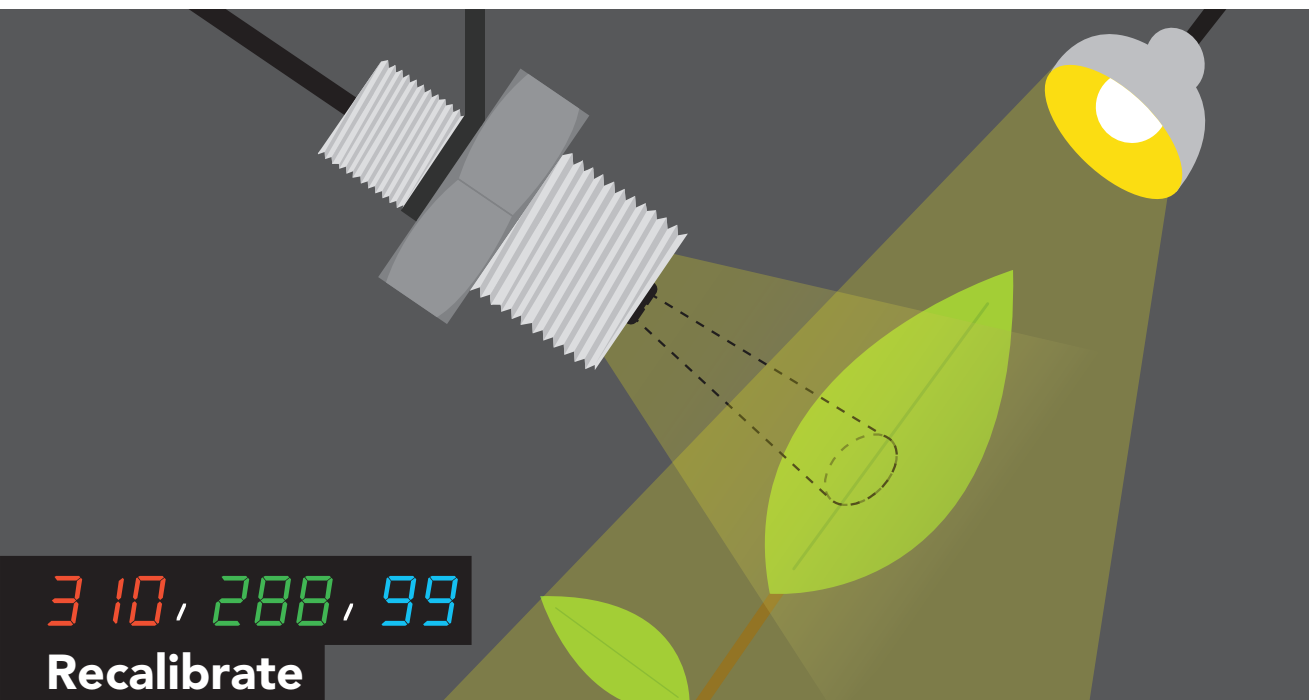

The RGB output has a three comma separated value, ranging from 0–255. However, It is possible to get RGB readings where one, or all of the values are greater than 255. This is because brightness is encoded in a RGB reading, if the subject being viewed is brighter than the calibrated brightness, the RGB values can go above 255. If this happens, the EZO-RGB™ Embedded Color Sensor needs to be re-calibrated for the correct brightness.

Data output

RGB

8-bit color graphics

Default output

8-bit Red }
8-bit Green } 24 bits in total
8-bit Blue }

Color pallet 16,777,216 colors (24 Bit)
Output frequency 1 reading every 400ms
Output format CSV string 24 bits

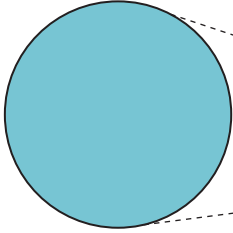
122, 196, 211 = 
8-bit Red 8-bit Green 8-bit Blue

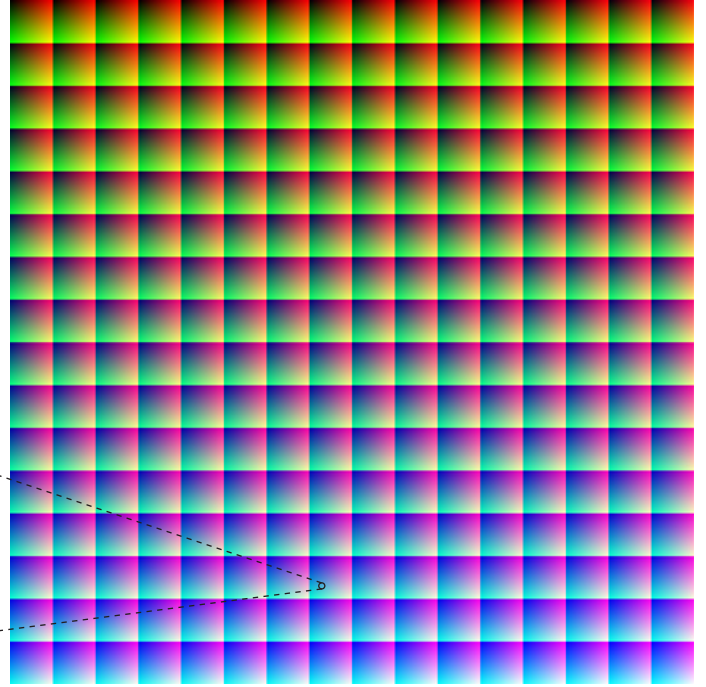

16,777,216 RGB colors

CIE 1931 color space

Human perception of color is not the same as a sensors perception of color. The CIE output is a representation of human color perception, while the RGB output is a representation of machine perception. While the two are close, they are not the same.

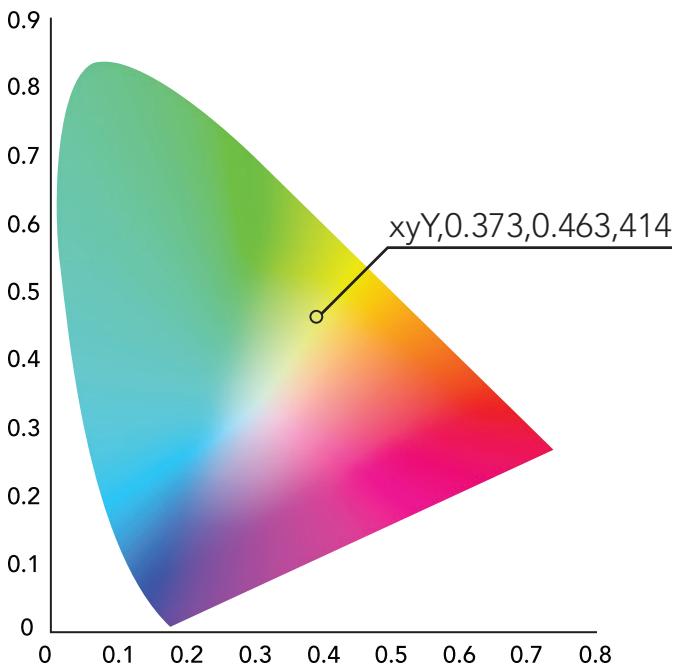

Identifier x y Y
xyY,0.373,0.463,414

xy = coordinates
Y = luminance

Lux

Lux is a measure of light intensity as perceived by the human eye. The lux output has a comma separated identifier "**Lux**" followed by a single integer value from 0 – 65535. Lux readings will be effected by the sensors position.

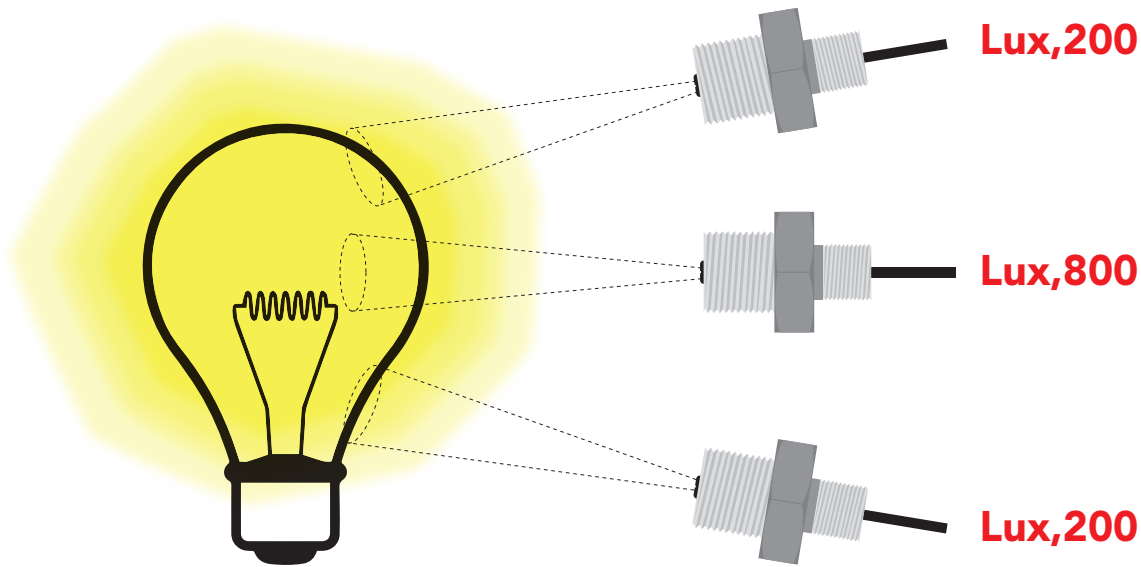

Color matching

The EZO-RGB™ can indicate when a preset color is detected.

Place object of any color under the sensor.
Issue command "M,1".
Color matching has been enabled.

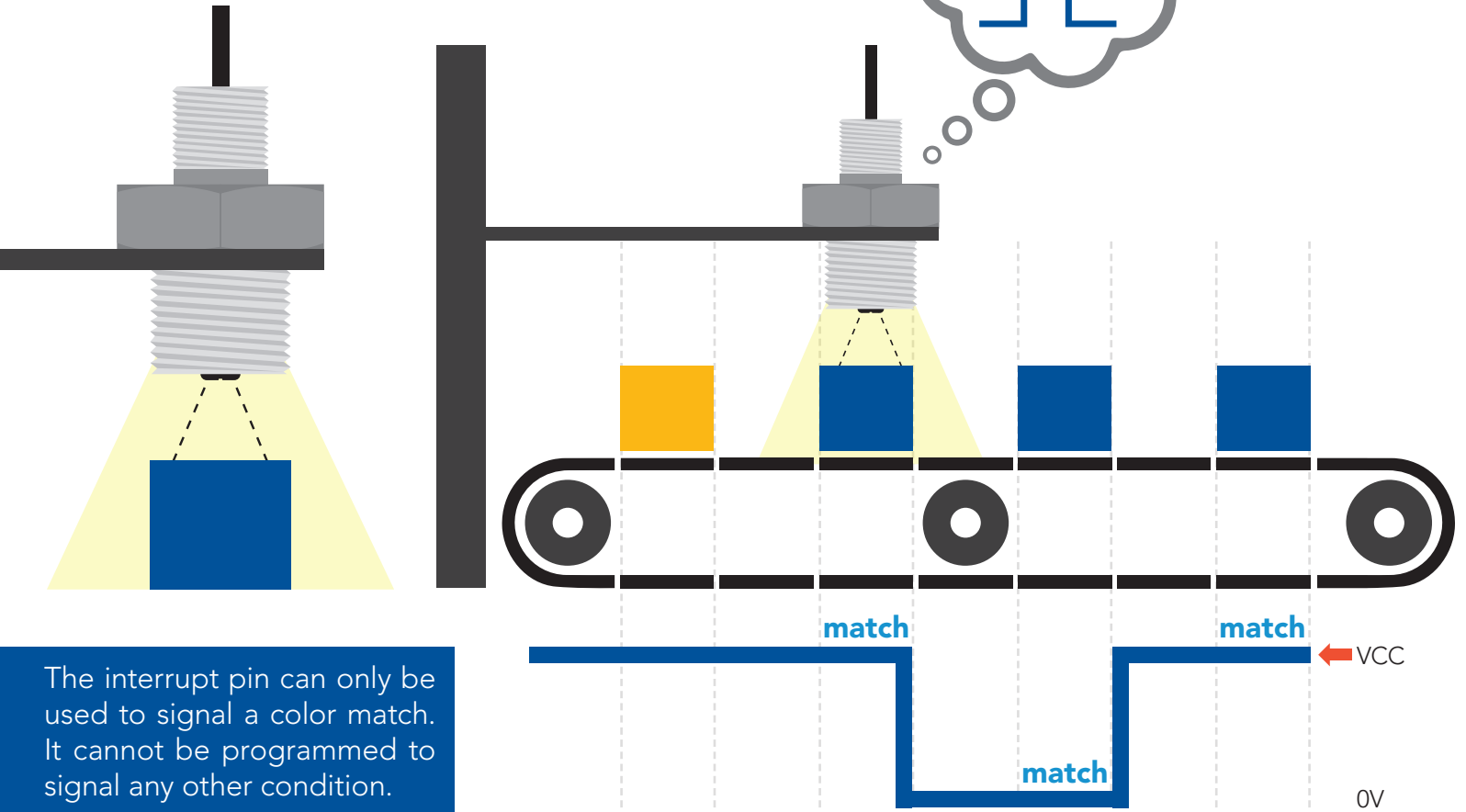

The interrupt pin can only be used to signal a color match. It cannot be programmed to signal any other condition.

When a color match has been detected the reading will be appended with **"*M"** and the interrupt pin will change its state.

In order for color matching to work the EZO-RGB™ must be securely mounted and remain a fixed distance from its target.

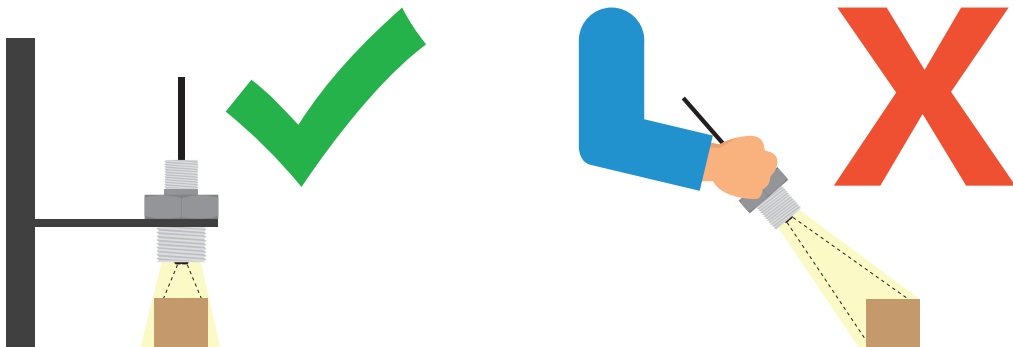

Default state

UART mode

Baud

9,600

Readings

continuous

Speed

400 milliseconds

LED

on, when taking reading

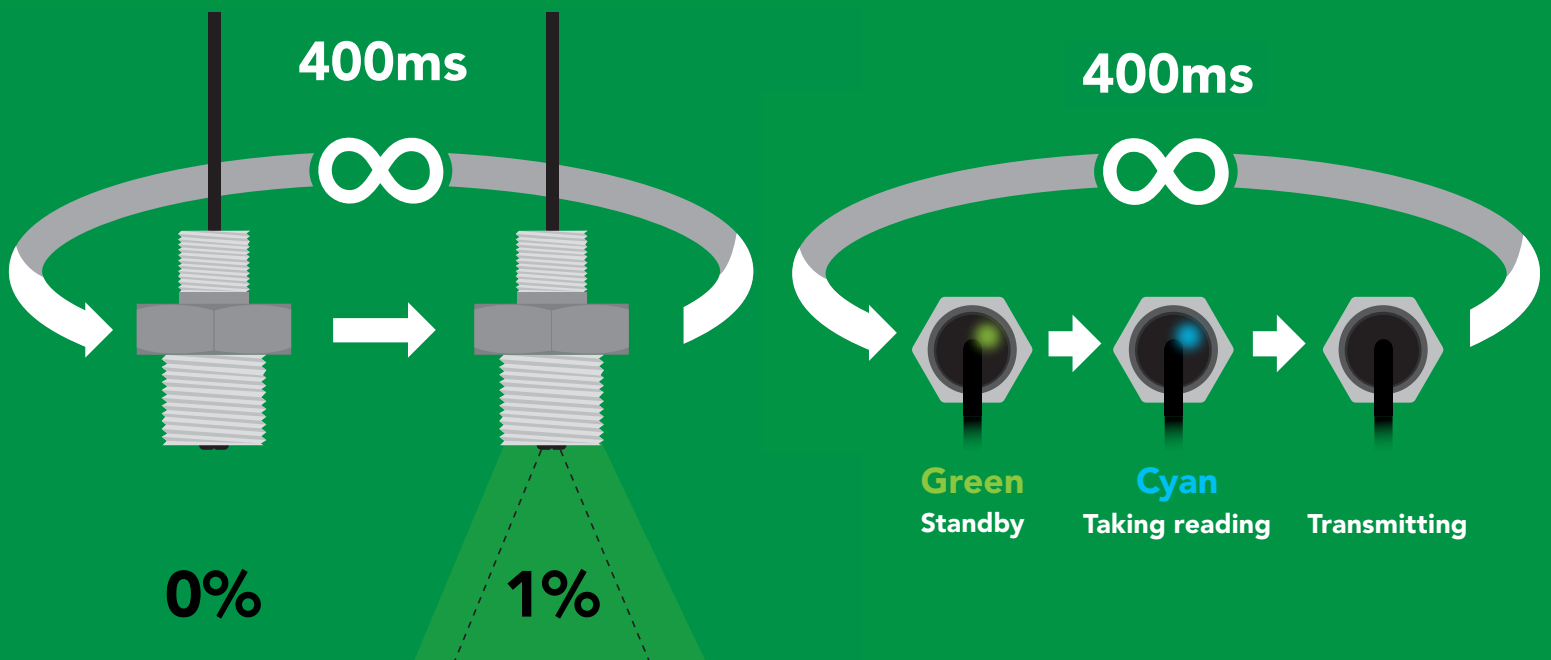

✓ Available data protocols

UART

default

I²C

✗ Unavailable data protocols

SPI

Analog

RS-485

Mod Bus

4–20mA

UART mode

Settings that are retained if power is cut

- Automatic color matching
- Baud rate
- Calibration
- Continuous mode
- Device name
- Enable/disable parameters
- Enable/disable response codes
- LED control

Settings that are **NOT** retained if power is cut

- Sleep mode

UART mode

8 data bits no parity
1 stop bit no flow control

Baud 300
1,200
2,400
9,600 default
19,200
38,400
57,600
115,200

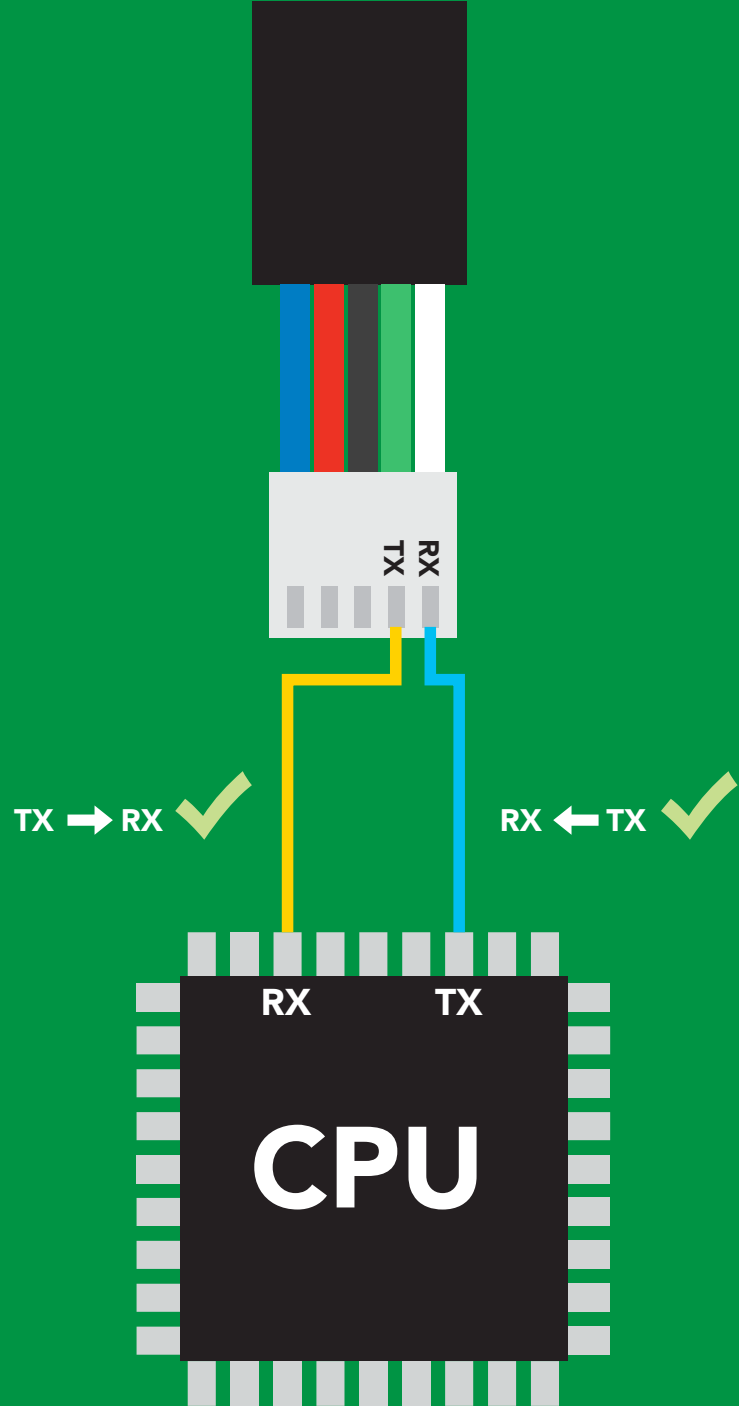
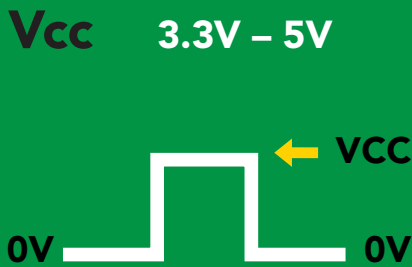

Data format

Units	RGB, LUX, & CIE	Data type	integer & floating point
Encoding	ASCII	Decimal places	3
Format	string	Smallest string	4 characters
Terminator	carriage return	Largest string	52 characters

Receiving data from device

2 parts

ASCII data string

Command

Carriage return <cr>

Terminator

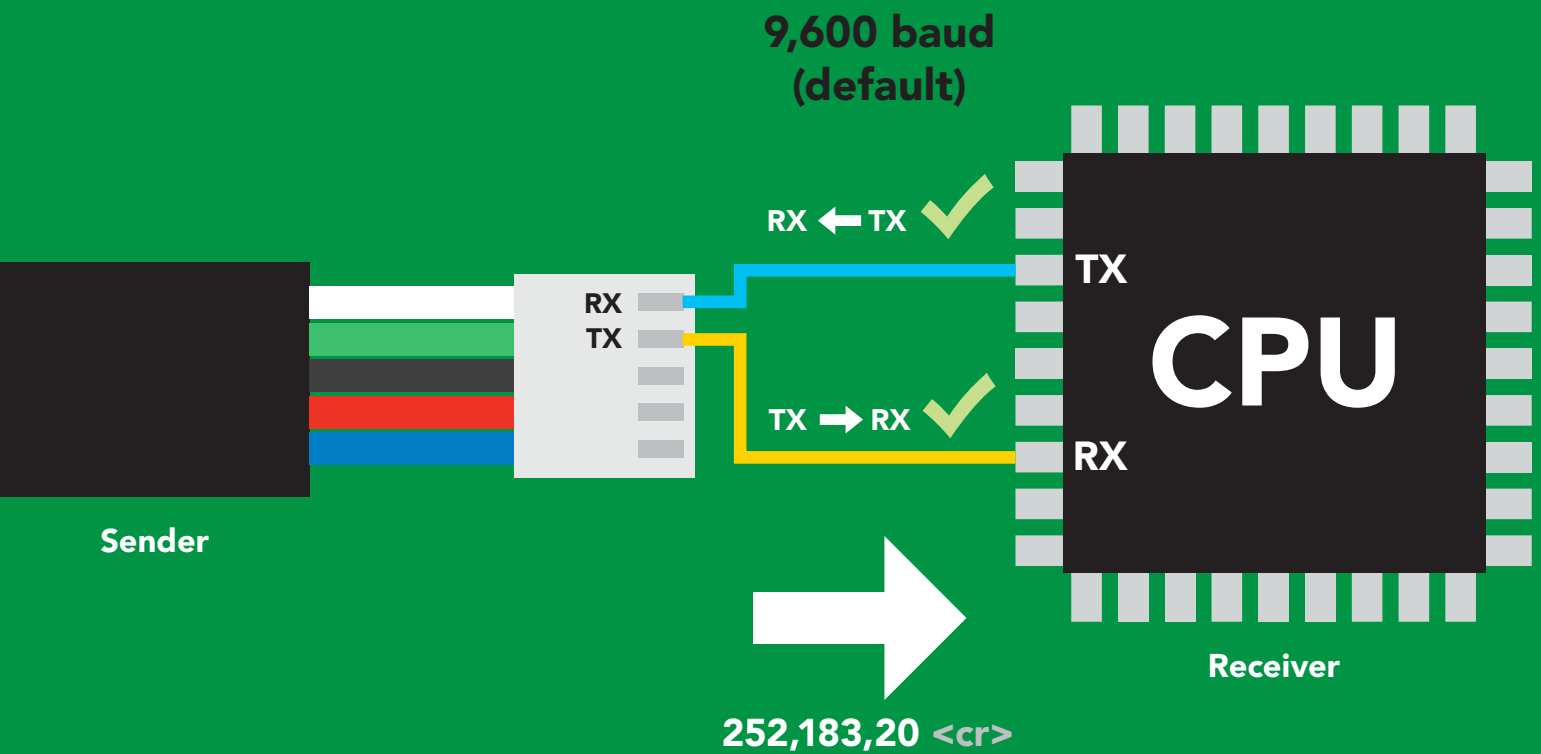

Advanced

ASCII: 2 5 2 , 1 8 3 , 2 0 <cr>

Hex: 32 35 32 2C 31 38 33 2C 32 30 0D

Dec: 50 53 50 44 49 56 51 44 50 48 13

Sending commands to device

2 parts

Command (not case sensitive)

ASCII data string

Carriage return <cr>

Terminator

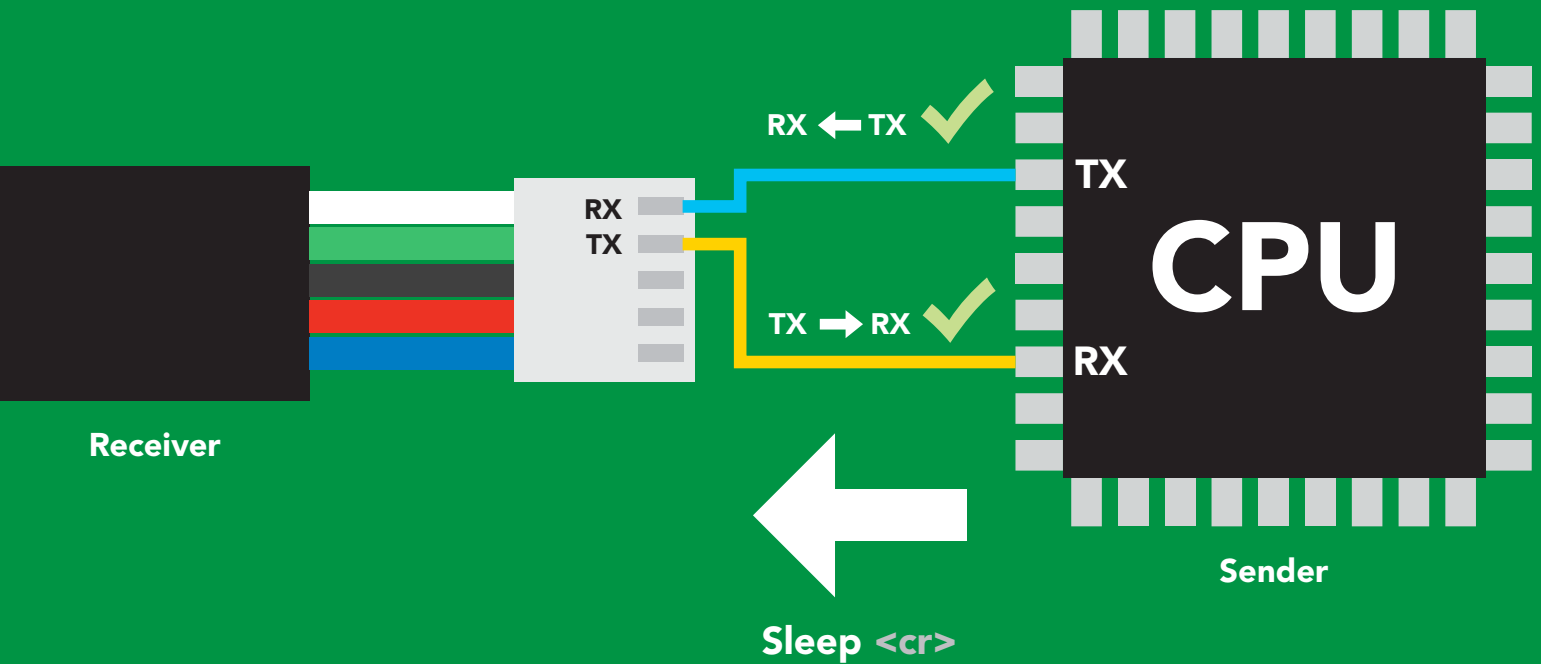

Advanced

ASCII: **S** **I** **e** **e** **p** **<cr>**

Hex: **53** **6C** **65** **65** **70** **0D**

Dec: **83** **108** **101** **101** **112** **13**

Indicator LED definition



Green

UART standby

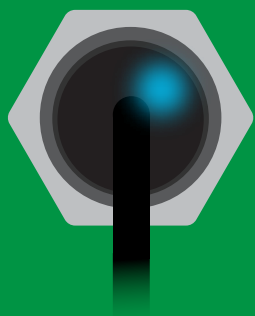

Cyan

Taking reading



Purple

Changing
I²C address



Red

Command
not understood

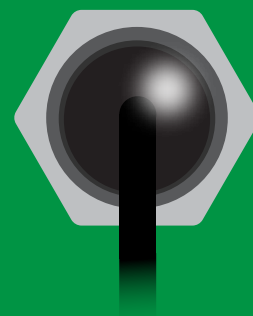

White

Find

5V

LED ON

+2.5 mA

3.3V

+1 mA

UART mode

command quick reference

All commands are ASCII strings or single ASCII characters.

Command	Function		Default state
Baud	change baud rate	pg. 37	9,600
C	enable/disable continuous mode	pg. 26	enabled
Cal	performs calibration	pg. 28	n/a
Factory	enable factory reset	pg. 39	n/a
Find	finds device with blinking white LED	pg. 25	n/a
G	gamma correction	pg. 30	n/a
i	device information	pg. 33	n/a
iL	enable/disable indicator LED	pg. 24	enabled
I2C	change to I ² C mode	pg. 40	not set
L	enable/disable target LED	pg. 23	enabled
M	automatic color matching	pg. 29	enabled
Name	set/show name of device	pg. 32	not set
O	enable/disable parameters	pg. 31	RGB
Plock	enable/disable protocol lock	pg. 38	n/a
R	returns a single reading	pg. 27	n/a
Sleep	enter sleep mode/low power	pg. 35	n/a
Status	retrieve status information	pg. 40	n/a
*OK	enable/disable response codes	pg. 34	n/a

Target LED control

Command syntax

% represents the percentage of target LED brightness. (any number from 0–100)

L,% <cr> set target LED brightness

L,%,T <cr> set target LED brightness/trigger target LED only when a reading is taken (*power saving*)

L,? <cr> target LED state on/off?

Example

Response

L,32 <cr>

*OK <cr> target LED set to 32% brightness.

L,14,T <cr>

*OK <cr> target LED set to 14% brightness, and will only turn on when a reading is taken.

L,? <cr>

?L, %, [T] <cr>

*OK <cr>

L,0 <cr>

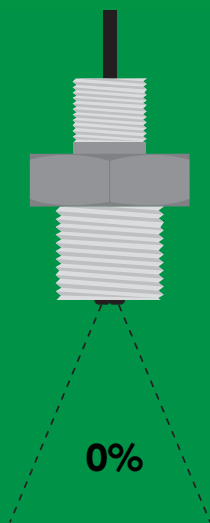

L,32 <cr>

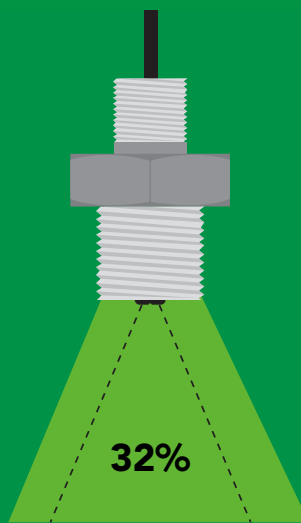

L,100 <cr>

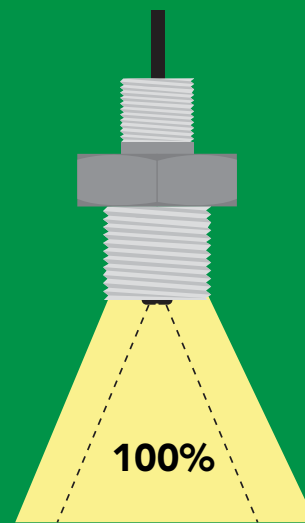

Indicator LED control

Command syntax

iL,1 <cr> indicator LED on **default**

iL,0 <cr> Indicator LED off

iL,? <cr> Indicator LED state on/off?

Example

Response

iL,1 <cr>

*OK <cr>

iL,0 <cr>

*OK <cr>

iL,? <cr>

?iL,1 <cr> or ?iL,0 <cr>
*OK <cr>



iL,1



iL,0

Find

Command syntax

This command will disable continuous mode
Send any character or command to terminate find.

Find <cr> LED rapidly blinks white, used to help find device

Example

Find <cr>

Response

*OK <cr>

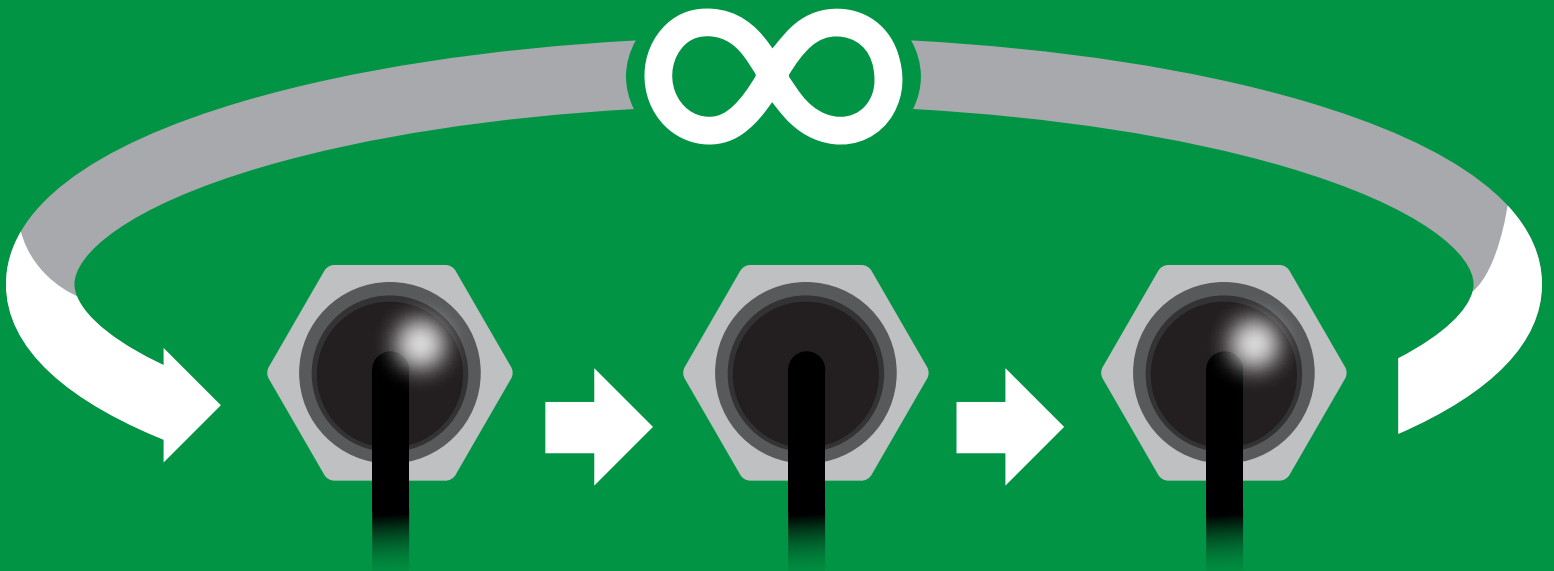

Continuous mode

Command syntax

- C,1** <cr> enable continuous readings once per 400ms **default**
- C,n** <cr> continuous readings every n x 400ms (n = 2 to 99)
- C,0** <cr> disable continuous readings
- C,?** <cr> continuous reading mode on/off?

Example

Response

C,1 <cr>

***OK** <cr>
R,G,B (400ms) <cr>
R,G,B (800ms) <cr>
R,G,B (1200ms) <cr>

C,30 <cr>

***OK** <cr>
R,G,B (12,000ms) <cr>
R,G,B (24,000ms) <cr>
R,G,B (36,000ms) <cr>

C,0 <cr>

***OK** <cr>

C,? <cr>

?C,1 <cr> **or** **?C,0** <cr> **or** **?C,30** <cr>
***OK** <cr>

Single reading mode

Command syntax

R <cr> takes single reading

Example

R <cr>

Response

R,G,B <cr>

***OK** <cr>

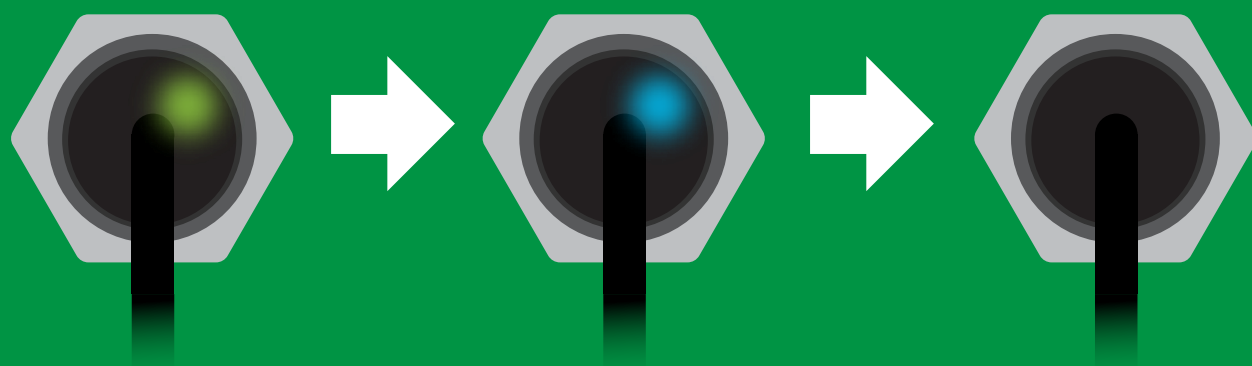

Green
Standby

Cyan
Taking reading

Transmitting



400ms

Calibration

Command syntax

Cal <cr> calibrates the EZO-RGB™

1. place white object (such as a piece of paper) in front of target
2. Issue "cal" command

Example

Cal <cr>

Response

***OK** <cr>

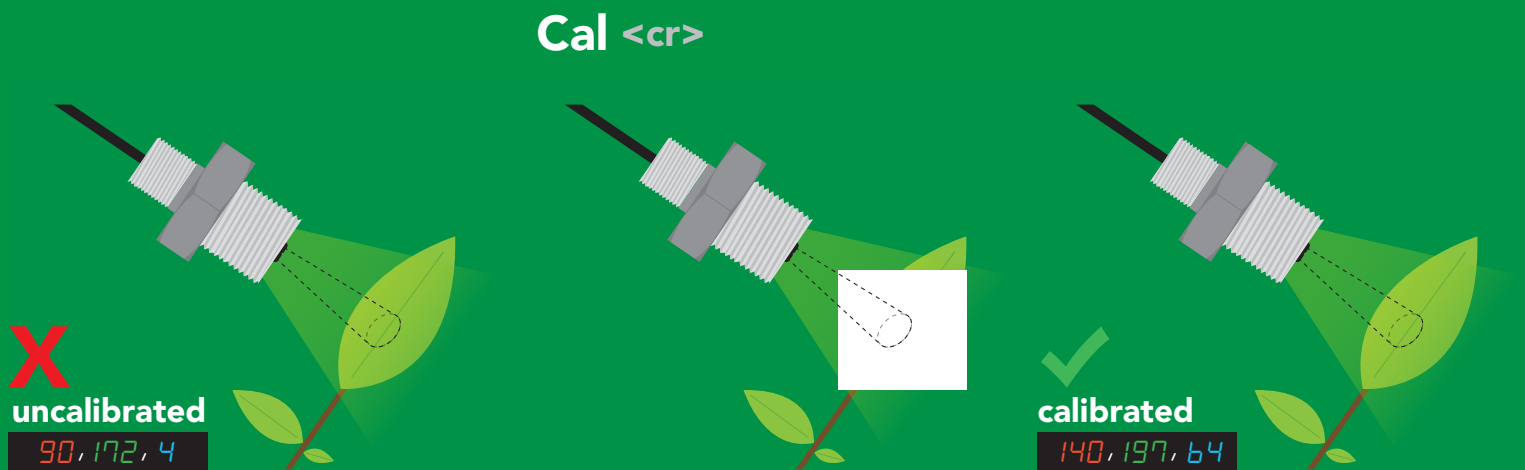

Automatic color matching

Command syntax

M,1 <cr> enables automatic color matching

M,0 <cr> disables automatic color matching

M,? <cr> color matching on/off?

Example

Response

M,1 <cr>

***OK** <cr>

M,0 <cr>

***OK** <cr>

M,? <cr>

?M,1 <cr> or **?M,0** <cr>

***OK** <cr>

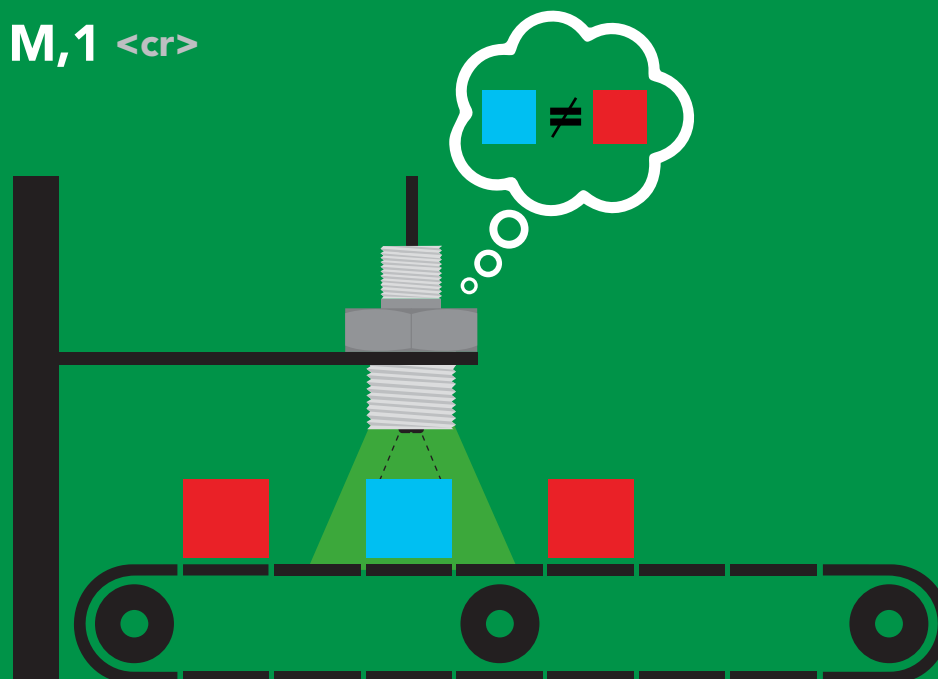

Gamma correction

Command syntax

Adjusting the gamma correction helps adjust the color seen by the sensor.

G,n <cr> **set gamma correction**

where n = a floating point number from 0.01 – 4.99

G,? <cr> **gamma correction value?**

The default gamma correction is 1.00 which represents no correction at all. A gamma correction factor is a floating point number from 0.01 to 4.99.

Example

Response

G,1.99 <cr>

***OK** <cr>

G,? <cr>

?G,1.99 <cr>
***OK** <cr>

Enable/disable parameters from output string

Command syntax

O, [parameter],[1,0] <cr> enable or disable output parameter
O,? <cr> enabled parameter?

Example

Response

O,RGB,1 / O,RGB,0 <cr>

*OK <cr> enable / disable RGB

O,LUX,1 / O,LUX,0 <cr>

*OK <cr> enable / disable lux

O,CIE,1 / O,CIE,0 <cr>

*OK <cr> enable / disable CIE

O,? <cr>

?,O,RGB,LUX,CIE <cr> if all enabled

Parameters

RGB red, green, blue
LUX illuminance
CIE CIE 1931 color space

Followed by 1 or 0

1 enabled
0 disabled

* If you disable all possible data types your readings will display "no output".

Naming device

Command syntax

Do not use spaces in the name

Name,n <cr> set name

Name, <cr> clears name

Name,? <cr> show name

n =

1 2 3 4 5 6 7 8 9 10 11 12 13 14 15 16

Up to 16 ASCII characters

Example

Response

Name, <cr>

*OK <cr> name has been cleared

Name,zzt <cr>

*OK <cr>

Name,? <cr>

?Name,zzt <cr>
*OK <cr>

Name,zzt



*OK <cr>

Name,?



?Name,zzt <cr>
*OK <cr>

Device information

Command syntax

```
i <cr> device information
```

Example

```
i <cr>
```

Response

```
?i,RGB,2.1 <cr>  
*OK <cr>
```

Response breakdown

```
?i, RGB, 2.1  
    ↑   ↑  
  Device Firmware
```

Response codes

Command syntax

- *OK,1** <cr> enable response **default**
- *OK,0** <cr> disable response
- *OK,?** <cr> response on/off?

Example

Response

R <cr>

140,197,64 <cr>
***OK** <cr>

***OK,0** <cr>

no response, ***OK** disabled

R <cr>

140,197,64 <cr> ***OK** disabled

***OK,?** <cr>

?*OK,1 <cr> or **?*OK,0** <cr>

Other response codes

- *ER** unknown command
- *OV** over volt ($VCC \geq 5.5V$)
- *UV** under volt ($VCC \leq 3.1V$)
- *RS** reset
- *RE** boot up complete, ready
- *SL** entering sleep mode
- *WA** wake up

These response codes cannot be disabled

Reading device status

Command syntax

Status <cr> voltage at Vcc pin and reason for last restart

Example

```
Status <cr>
```

Response

```
?Status,P,5.038 <cr>  
*OK <cr>
```

Response breakdown

?Status,	P,	5.038
	↑	↑
	Reason for restart	Voltage at Vcc

Restart codes

P	powered off
S	software reset
B	brown out
W	watchdog
U	unknown

Sleep mode/low power

Command syntax

Send any character or command to awaken device.

Sleep <cr> enter sleep mode/low power

Example

Response

Sleep <cr>

*OK <cr>

*SL <cr>

Any command

*WA <cr> wakes up device

5V

MAX	SLEEP
175 mA	0.40 mA

3.3V

138 mA	0.18 mA
--------	---------

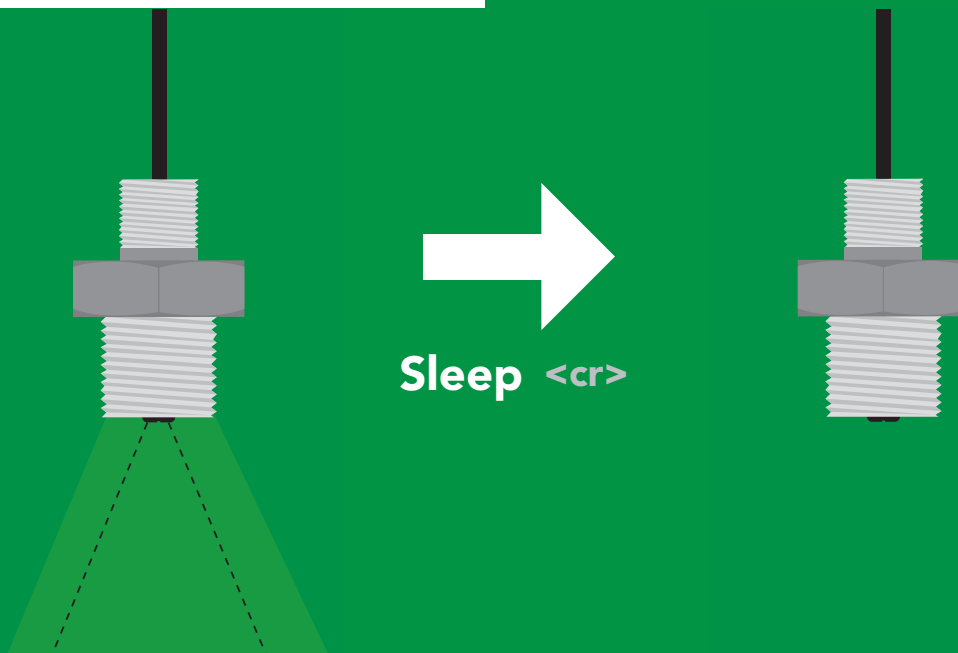

Change baud rate

Command syntax

Baud,n <cr> change baud rate

Example

Baud,38400 <cr>

Response

*OK <cr>

Baud,? <cr>

?Baud,38400 <cr>

*OK <cr>

n =

- 300
- 1200
- 2400
- 9600 default**
- 19200
- 38400
- 57600
- 115200



Standby

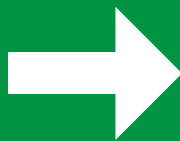

Baud,38400 <cr>

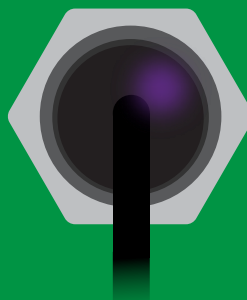

Changing
baud rate

*OK <cr>

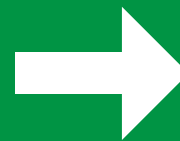

(reboot)



Standby

Protocol lock

Command syntax

Locks device to UART mode.

Plock,1 <cr> enable Plock

Plock,0 <cr> disable Plock **default**

Plock,? <cr> Plock on/off?

Example

Response

Plock,1 <cr>

***OK** <cr>

Plock,0 <cr>

***OK** <cr>

Plock,? <cr>

?Plock,1 <cr> **or** **?Plock,0** <cr>

Plock,1



***OK** <cr>

I2C,100

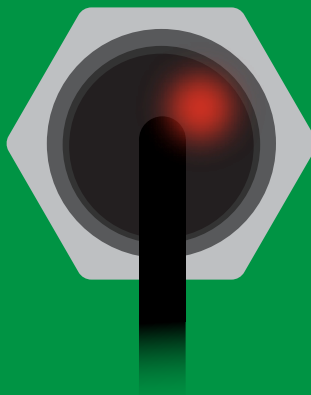

cannot change to I²C

***ER** <cr>

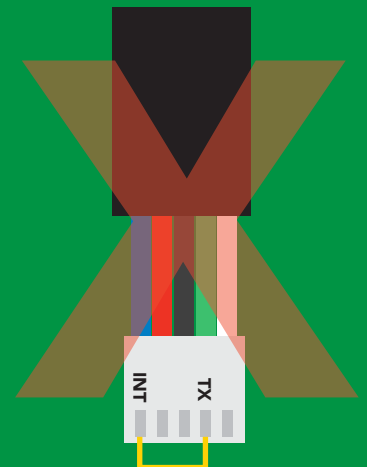

cannot change to I²C

Factory reset

Command syntax

Clears calibration
Reset target LED brightness to 1%
Reset output to RGB
"*OK" enabled

Factory <cr> enable factory reset

Example

Response

Factory <cr>

*OK <cr>

Factory <cr>

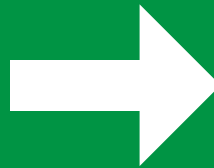

(reboot)



*OK <cr>

*RS <cr>
*RE <cr>

Baud rate will not change

Change to I²C mode

Command syntax

Default I²C address 112 (0x70)

I2C,n <cr> sets I²C address and reboots into I²C mode

n = any number 1 – 127

Example

Response

I2C,100 <cr>

*OK (reboot in I²C mode)

Wrong example

Response

I2C,139 <cr> n ≠ 127

*ER <cr>

I2C,100



Green
*OK <cr>

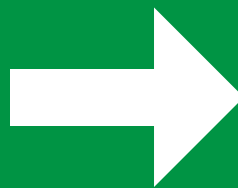

(reboot)



Blue
now in I²C mode

Manual switching to I²C

- Disconnect ground (power off)
- Disconnect TX and RX
- Connect TX to INT
- Confirm RX is disconnected
- Connect ground (power on)
- Wait for LED to change from **Green** to **Blue**
- Disconnect ground (power off)
- Reconnect all data and power

Manually switching to I²C will set the I²C address to 112 (0x70)

Example

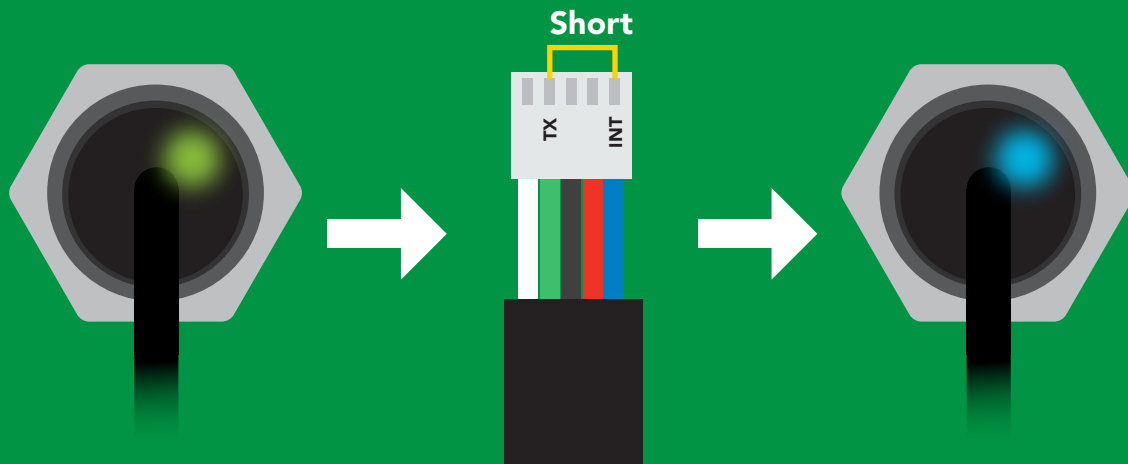

Wrong Example

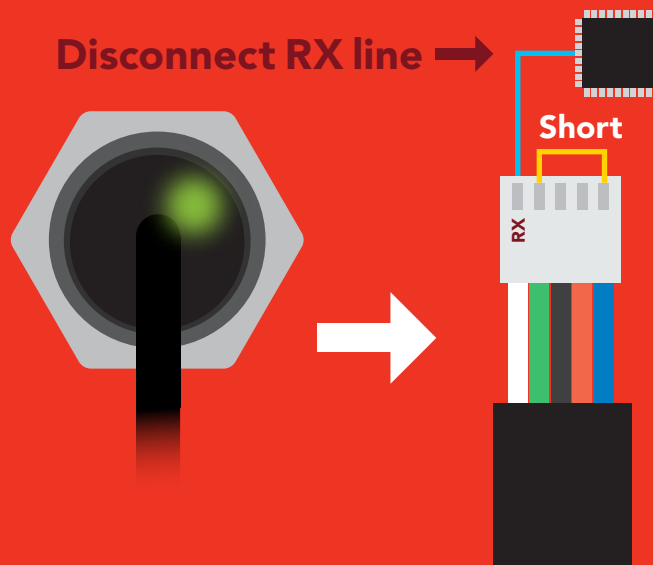

I²C mode

The I²C protocol is *considerably more complex* than the UART (RS-232) protocol. Atlas Scientific assumes the embedded systems engineer understands this protocol.

To set your EZO™ device into I²C mode click [here](#)

Settings that are retained if power is cut

- Automatic color matching
- Calibration
- Change I²C address
- Hardware switch to UART mode
- LED control
- Protocol lock
- Software switch to UART mode

Settings that are *NOT* retained if power is cut

- Sleep mode

I²C mode

I²C address (0x01 – 0x7F)
112 (0x70) default

Vcc 3.3V – 5.5V

Clock speed 100 – 400 kHz

SDA 

SCL 

0V VCC 0V

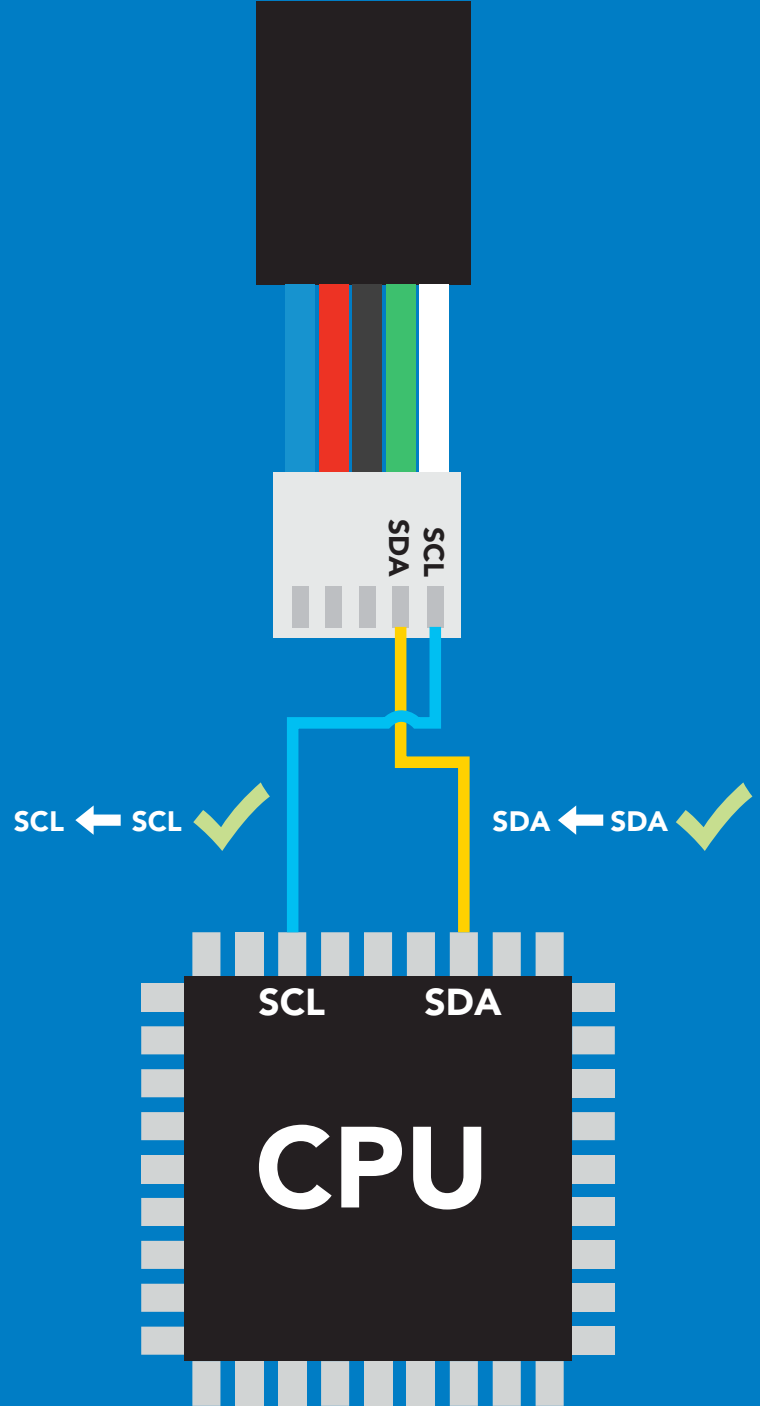

Data format

Units RGB, LUX, & CIE

Encoding ASCII

Format string

Terminator carriage return

Data type

integer &
floating point

Decimal places 3

Smallest string 4 characters

Largest string 52 characters

Sending commands to device



Example

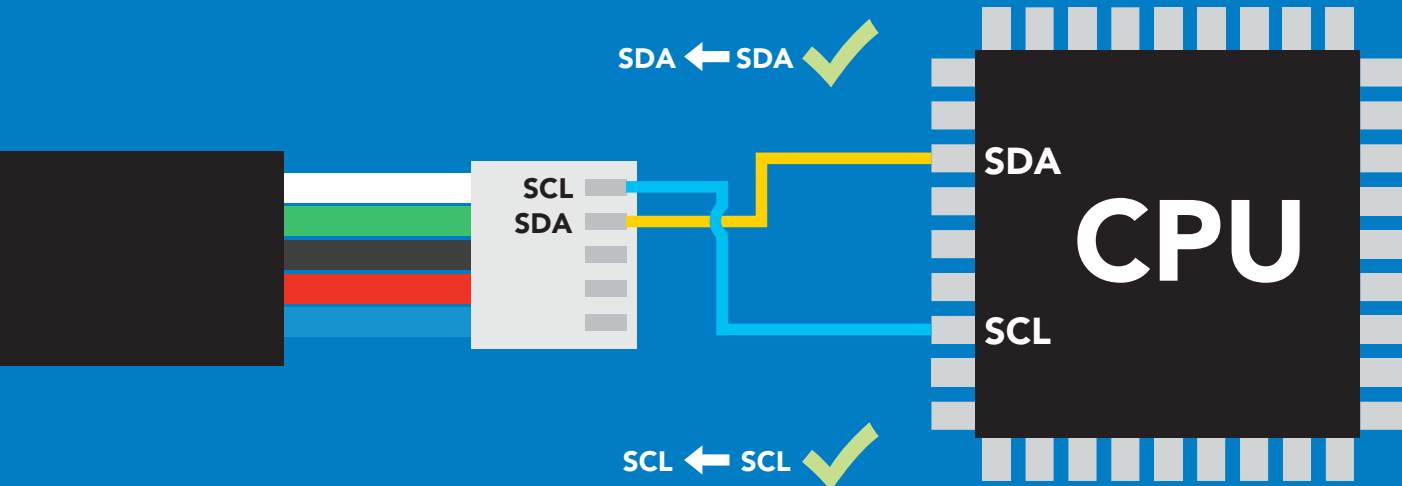

Advanced

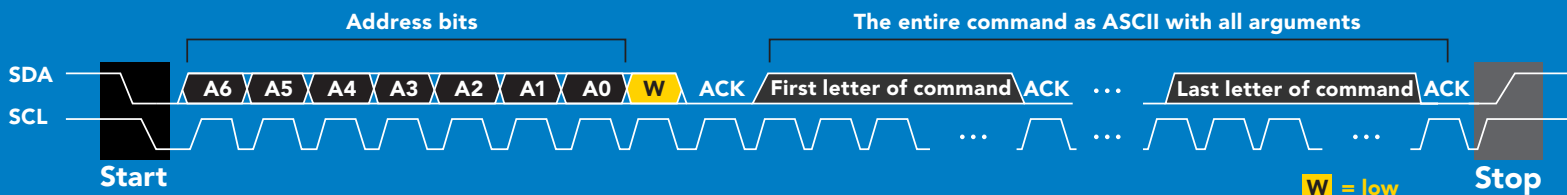

Response codes & processing delay

After a command has been issued, a 1 byte response code can be read in order to confirm that the command was processed successfully.

Reading back the response code is completely optional, and is not required for normal operation.

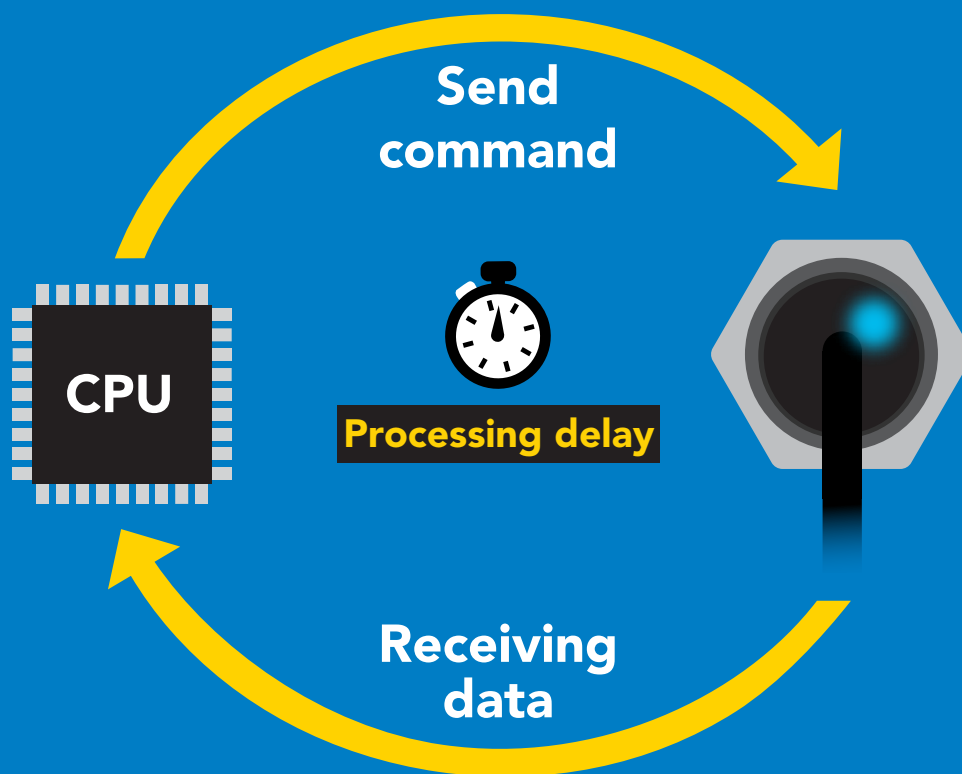

Example

```
I2C_start;  
I2C_address;  
I2C_write(EZO_command);  
I2C_stop;
```

`delay(300);`



Processing delay

```
I2C_start;  
I2C_address;  
Char[ ] = I2C_read;  
I2C_stop;
```

If there is no processing delay or the processing delay is too short, the response code will always be 254.

Response codes

Single byte, not string

255	no data to send
254	still processing, not ready
2	syntax error
1	successful request

Indicator LED control

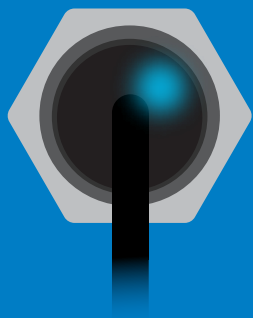

Blue

I²C standby



Green

Taking reading

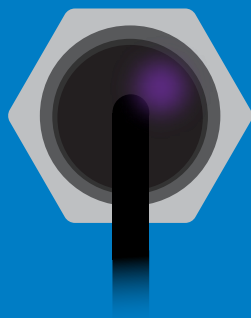

Purple

Changing
I²C address

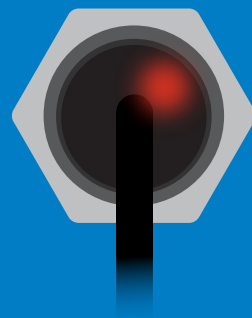

Red

Command
not understood

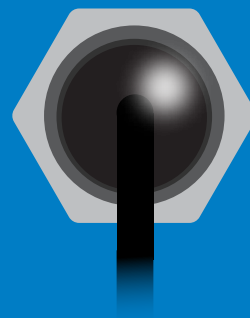

White

Find

5V	LED ON +2.5 mA
3.3V	+1 mA

I²C mode

command quick reference

All commands are ASCII strings or single ASCII characters.

Command	Function	
Baud	switch back to UART mode	pg. 63
Cal	performs custom calibration	pg. 53
Factory	enable factory reset	pg. 62
Find	finds device with blinking white LED	pg. 51
G	gamma correction	pg. 54
i	device information	pg. 57
iL	enable/disable indicator LED	pg. 50
I2C	change I ² C address	pg. 61
L	enable/disable target LED	pg. 49
Name	set/show name of device	pg. 56
O	enable/disable parameters	pg. 55
Plock	enable/disable protocol lock	pg. 60
R	returns a single reading	pg. 52
Sleep	enter sleep mode/low power	pg. 59
Status	retrieve status information	pg. 58

Target LED control

300ms  processing delay

Command syntax

% represents the percentage of target LED brightness. (any number from 0–100)

- L,% set target LED brightness
- L,%T set target LED brightness/trigger target LED only when a reading is taken (*power saving*)
- L,? target LED state on/off?

Example

Response

L,32  Wait 300ms

1	0
Dec	Null

 target LED set to 32% brightness.

L,14,T  Wait 300ms

1	0
Dec	Null

 target LED set to 14% brightness, and will only turn on when a reading is taken.

L,?  Wait 300ms

1	?L, %, [T]	0
Dec	ASCII	Null

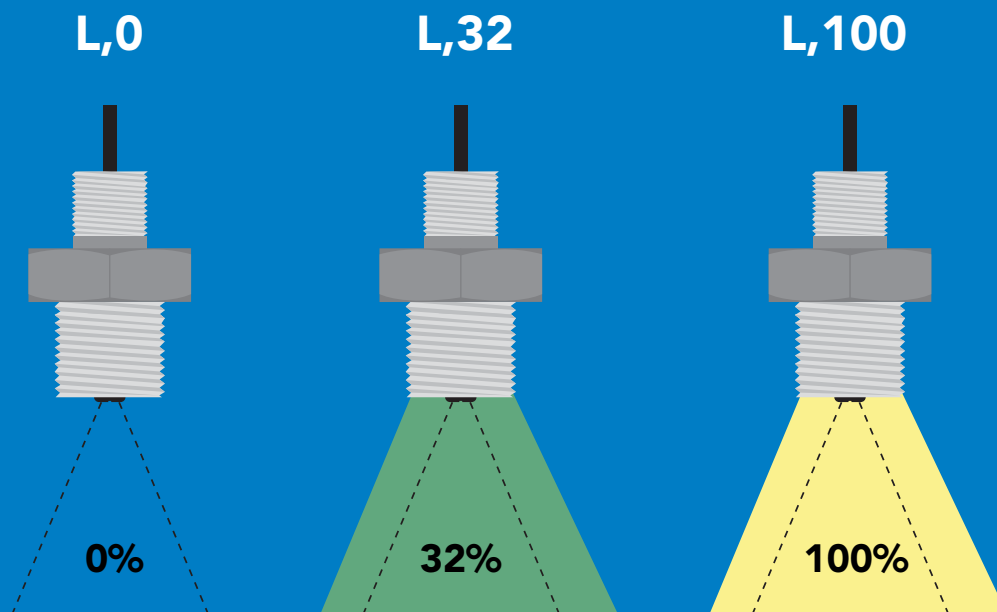

Indicator LED control

Command syntax

300ms  processing delay

- iL,1 indicator LED on **default**
- iL,0 Indicator LED off
- iL,? Indicator LED state on/off?

Example

Response

iL,1

 **Wait 300ms** **1** **0**
Dec Null

iL,0

 **Wait 300ms** **1** **0**
Dec Null

iL,?

 **Wait 300ms** **1** **?iL,1** **0** or  **Wait 300ms** **1** **?iL,0** **0**
Dec ASCII Null Dec ASCII Null

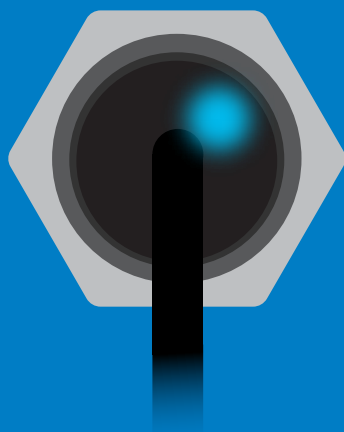

iL,1

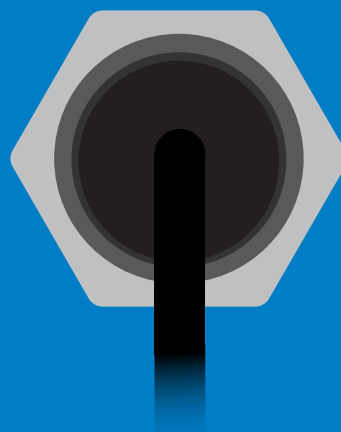

iL,0

Find

Command syntax

300ms  processing delay

Find LED rapidly blinks white, used to help find device

Example

Response

Find

 Wait 300ms **1** Dec **0** Null

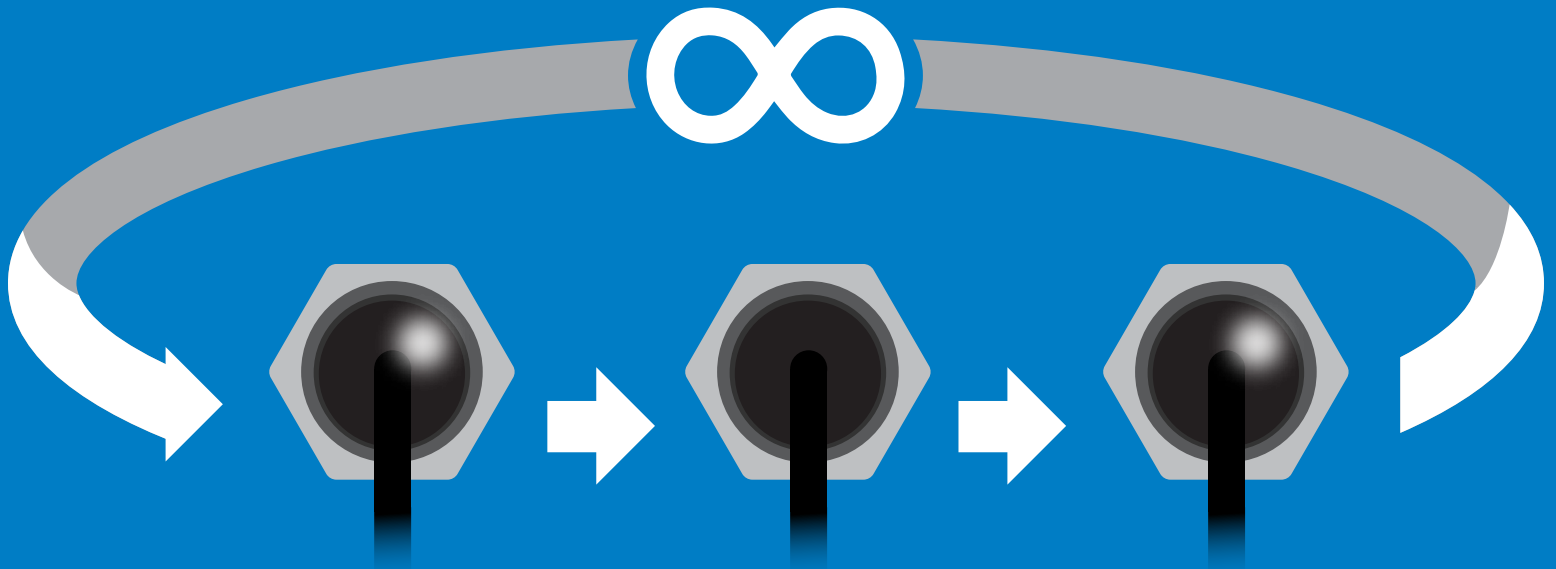

Taking reading

Command syntax

300ms  processing delay

R return 1 reading

Example

Response

R  **1** **R,G,B** **0**
Wait 300ms Dec ASCII Null

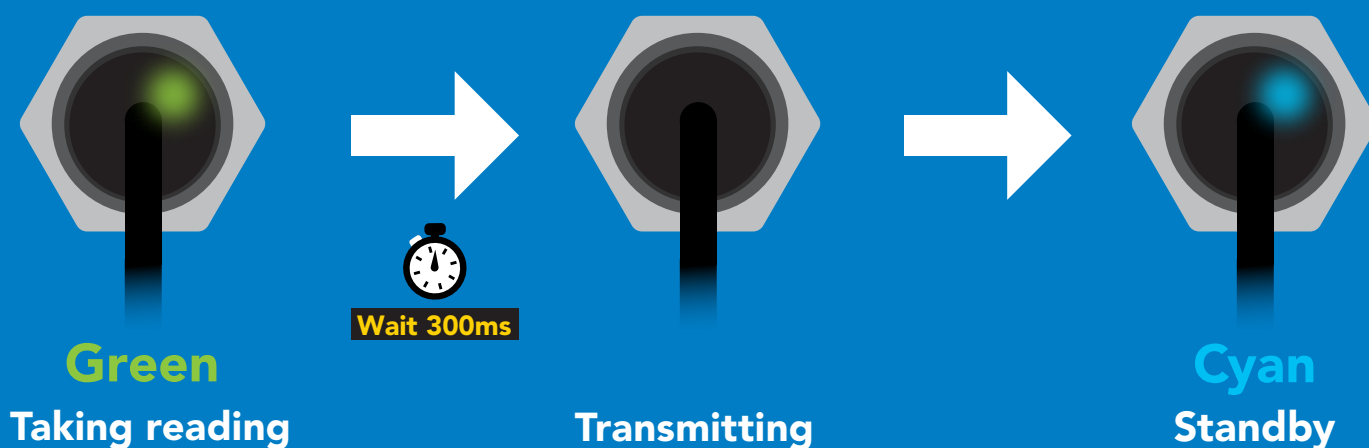

Calibration

Command syntax

300ms  processing delay

Cal calibrates the EZO-RGB™

1. place white object (such as a piece of paper) in front of target
2. Issue "cal" command

Example

Cal

Response

 Wait 300ms **1** Dec **0** Null

Cal

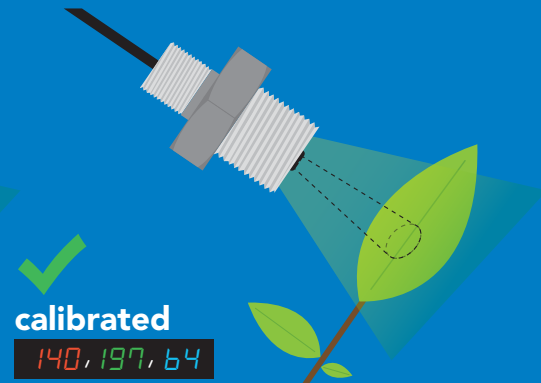
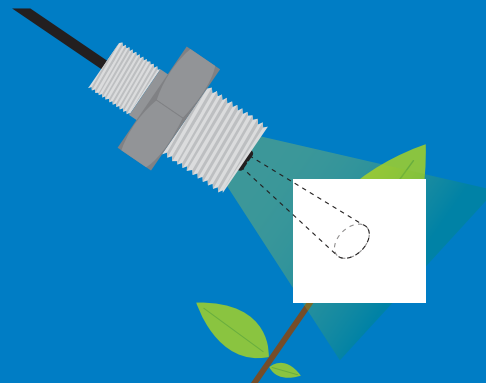
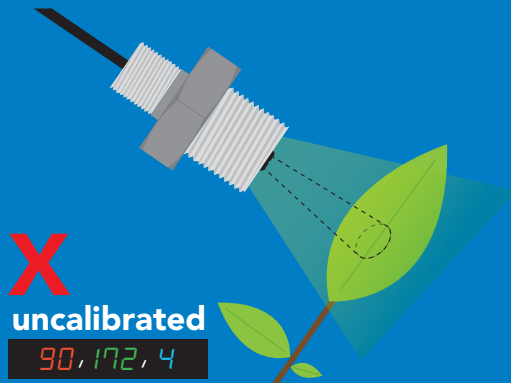

Gamma correction

300ms  processing delay

Command syntax

Adjusting the gamma correction helps adjust the color seen by the sensor.

G,n set gamma correction

where n = a floating point number from 0.01 – 4.99

G,? gamma correction value?

The default gamma correction is 1.00 which represents no correction at all.
A gamma correction factor is a floating point number from 0.01 to 4.99.

Example

Response

G,1.99



Wait 300ms

1

Dec

0

Null

G,?



Wait 300ms

1

Dec

?G,1.99

ASCII

0

Null

Enable/disable parameters from output string

Command syntax

O, [parameter],[1,0] enable or disable output parameter
O,? enabled parameter?

Example

O,RGB,1 / O,RGB,0

Response

 **Wait 300ms** **1** **0** enable / disable RGB
Dec Null

O,LUX,1 / O,LUX,0

 **Wait 300ms** **1** **0** enable / disable lux
Dec Null

O,CIE,1 / O,CIE,0

 **Wait 300ms** **1** **0** enable / disable CIE
Dec Null

O,?

 **Wait 300ms** **1** **? , O, RGB, LUX, CIE** **0** if all enabled
Dec ASCII Null

Parameters

RGB red, green, blue
LUX illuminance
CIE CIE 1931 color space

Followed by 1 or 0

1 enabled
0 disabled

*** If you disable all possible data types your readings will display "no output".**

Naming device

300ms  processing delay

Command syntax

Do not use spaces in the name

Name,n	set name	n =	1	2	3	4	5	6	7	8	9	10	11	12	13	14	15	16	
Name,	clears name																		
Name,?	show name																		

Up to 16 ASCII characters

Example

Response

Name,



1 0
Dec Null

name has been cleared

Name,zzt



1 0
Dec Null

Name,?



1 ?Name,zzt 0
Dec ASCII Null

Name,zzt

Name,?

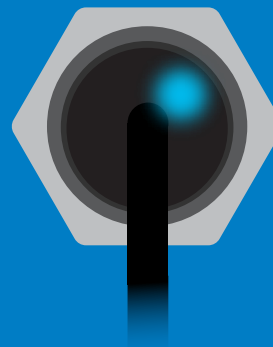
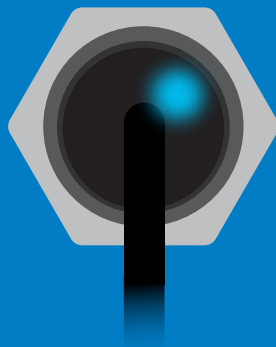

1 0

1 ?Name,zzt 0

Device information

Command syntax

300ms  processing delay

i device information

Example

Response

i



Wait 300ms

1

Dec

?i,RGB,2.1

ASCII

0

Null

Response breakdown

?i, RGB, 2.1
↑ ↑
Device Firmware

Reading device status

Command syntax

300ms  processing delay

Status voltage at Vcc pin and reason for last restart

Example

Response

Status

 **1** **?Status,P,5.038** **0**
Wait 300ms Dec ASCII Null

Response breakdown

?Status, **P,** **5.038**
Reason for restart Voltage at Vcc

Restart codes

P powered off
S software reset
B brown out
W watchdog
U unknown

Sleep mode/low power

Command syntax

Sleep enter sleep mode/low power

Send any character or command to awaken device.

Example

Response

Sleep

no response

Do not read status byte after issuing sleep command.

Any command

wakes up device

5V	STANDBY 45 mA	SLEEP 3.4 mA
3.3V	42 mA	3.0 mA

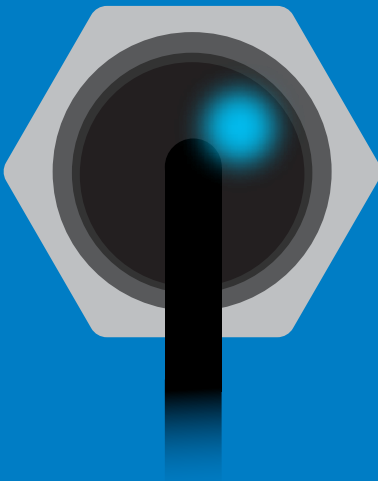

Standby

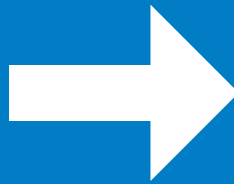

Sleep

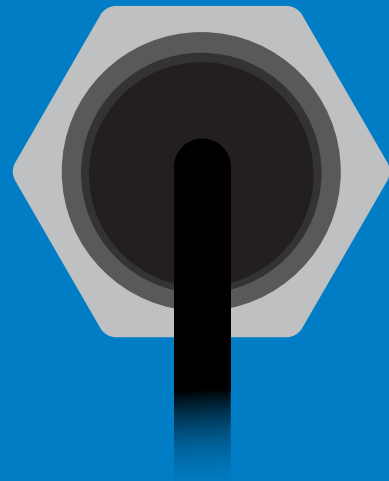

Sleep

Protocol lock

Command syntax

300ms  processing delay

Plock,1 enable Plock

Plock,0 disable Plock

Plock,? Plock on/off?

Locks device to I²C mode.

default

Example

Response

Plock,1

Wait 300ms

1	0
Dec	Null

Plock,0

Wait 300ms

1	0
Dec	Null

Plock,?

Wait 300ms

1	?Plock,1	0
Dec	ASCII	Null

Plock,1

Baud, 9600

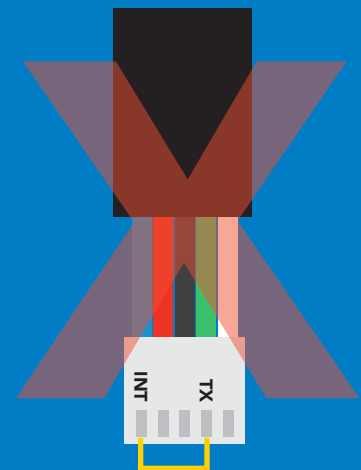
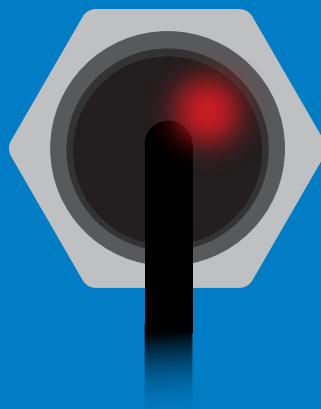
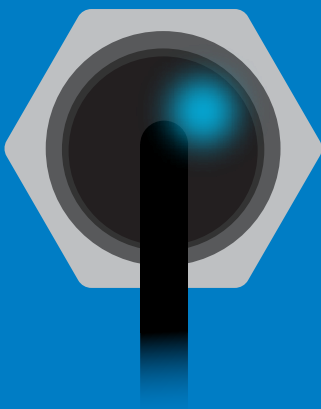

cannot change to UART

cannot change to UART

I²C address change

Command syntax

I2C,n sets I²C address and reboots into I²C mode

Example

I2C,101

Response

device reboot
(no response given)

Warning!

Changing the I²C address will prevent communication between the circuit and the CPU until the CPU is updated with the new I²C address.

Default I²C address is 112 (0x70).

n = any number 1 – 127

I2C,101

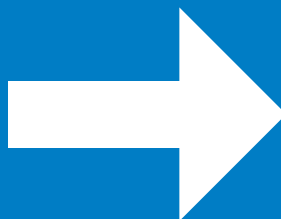
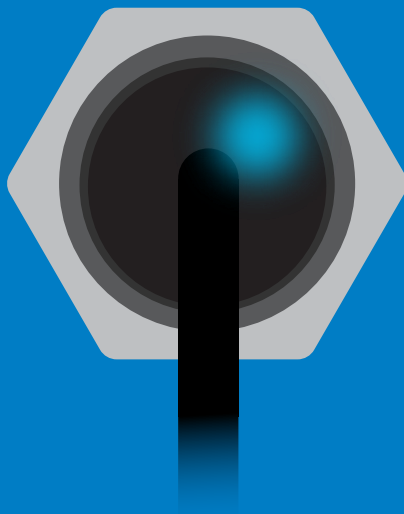

(reboot)



Factory reset

Command syntax

Factory reset will not take the device out of I²C mode.

Factory enable factory reset

I²C address will not change

Example

Response

Factory

device reboot
(no response given)

Clears custom calibration
LED on
Response codes enabled

Factory

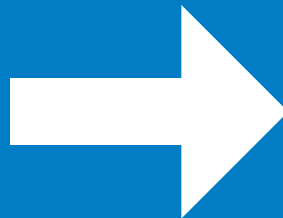
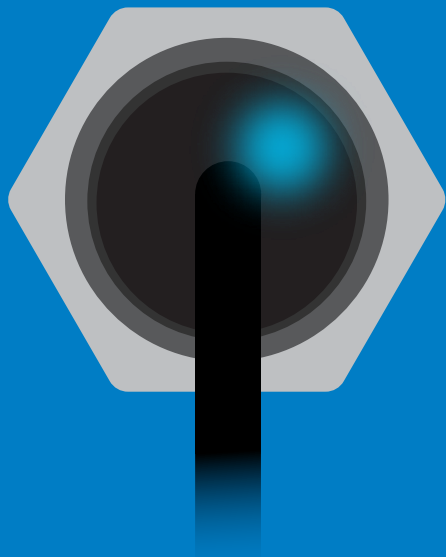

(reboot)



Change to UART mode

Command syntax

Baud,n switch from I²C to UART

Example

Baud,9600

Response

reboot in UART mode
(no response given)

n = [300
1200
2400
9600
19200
38400
57600
115200

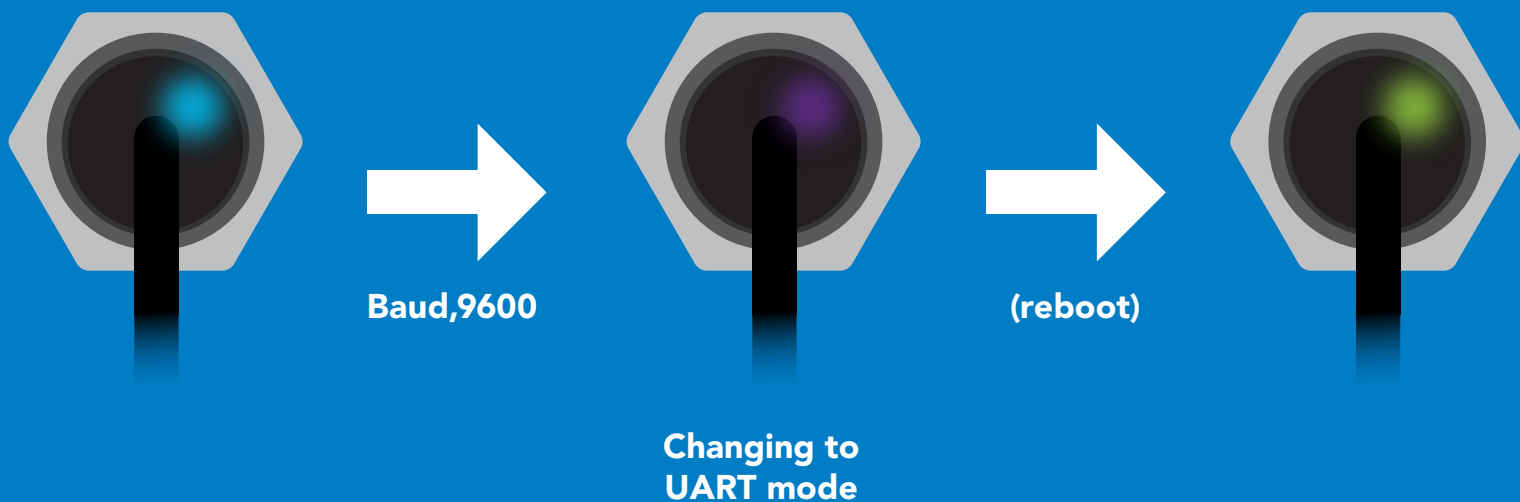

Manual switching to UART

- Disconnect ground (power off)
- Disconnect TX and RX
- Connect TX to INT
- Confirm RX is disconnected
- Connect ground (power on)
- Wait for LED to change from **Blue** to **Green**
- Disconnect ground (power off)
- Reconnect all data and power

Example

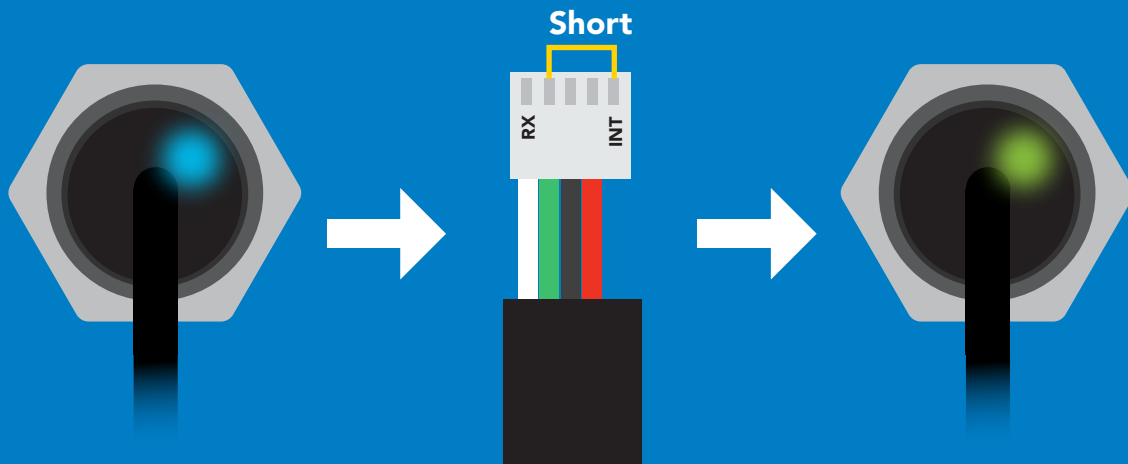

Wrong Example

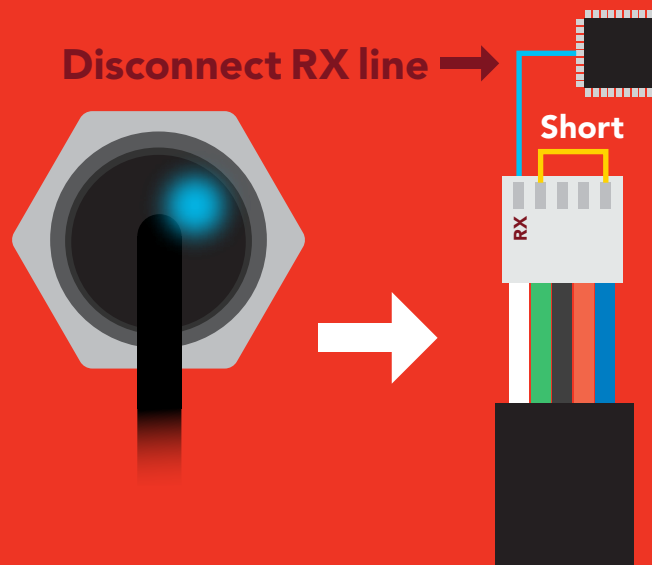

Datasheet change log

Datasheet V 2.8

Revised naming device info on pages 32 & 56.

Datasheet V 2.7

Removed proximity sensing capabilities from device.

Datasheet V 2.6

Added new feature info on pg 2.

Datasheet V 2.5

Corrected typo on pg 54.

Datasheet V 2.4

Moved Default state to pg 18.

Datasheet V 2.3

Changed the default I2C Address to 112 (0x70)

Datasheet V 2.2

Added an I²C section to the datasheet.

Datasheet V 2.1

Revised response for the sleep command in UART mode on pg 39.

Datasheet V 2.0

Revised entire datasheet

Firmware updates

V1.10 – (November 7, 2015)

- Fixed sleep mode bug.

V1.15 – (November 30, 2015)

- Fixed threshold bug.

V1.16 – (February 2, 2016)

- Fixed bug where excessive newline characters would be output for every line.

v1.18 - (Sept 19, 2016)

- Updated manufacturing process.

v1.20 - (June 29, 2017)

- Issuing the I²C command will return with an error.

v2.00 - (May 1, 2019)

- Added the RGB indicator LED and I²C mode, find command, C,n command

v2.10 - (August 23, 2021)

- Proximity sensing capabilities removed (*feature was hardly ever used*).

Warranty

Atlas Scientific™ Warranties the EZO-RGB™ Embedded Color Sensor to be free of defect during the debugging phase of device implementation, or 30 days after receiving the EZO-RGB™ Embedded Color Sensor (which ever comes first).

The debugging phase

The debugging phase as defined by Atlas Scientific™ is the time period when the EZO-RGB™ Embedded Color Sensor is connected into a bread board, or shield. If the EZO-RGB™ Embedded Color Sensor is being debugged in a bread board, the bread board must be devoid of other components. If the EZO-RGB™ Embedded Color Sensor is being connected to a microcontroller, the microcontroller must be running code that has been designed to drive the EZO-RGB™ Embedded Color Sensor exclusively and output the EZO-RGB™ Embedded Color Sensor data as a serial string.

It is important for the embedded systems engineer to keep in mind that the following activities will void the EZO-RGB™ Embedded Color Sensor warranty:

- **Soldering any part to the EZO-RGB™ Embedded Color Sensor.**
- **Running any code, that does not exclusively drive the EZO-RGB™ Embedded Color Sensor and output its data in a serial string.**
- **Embedding the EZO-RGB™ Embedded Color Sensor into a custom made device.**
- **Removing any potting compound.**

Reasoning behind this warranty

Because Atlas Scientific™ does not sell consumer electronics; once the device has been embedded into a custom made system, Atlas Scientific™ cannot possibly warranty the EZO-RGB™ Embedded Color Sensor, against the thousands of possible variables that may cause the EZO-RGB™ Embedded Color Sensor to no longer function properly.

Please keep this in mind:

- 1. All Atlas Scientific™ devices have been designed to be embedded into a custom made system by you, the embedded systems engineer.**
- 2. All Atlas Scientific™ devices have been designed to run indefinitely without failure in the field.**
- 3. All Atlas Scientific™ devices can be soldered into place, however you do so at your own risk.**

Atlas Scientific™ is simply stating that once the device is being used in your application, Atlas Scientific™ can no longer take responsibility for the EZO-RGB™ Embedded Color Sensor continued operation. This is because that would be equivalent to Atlas Scientific™ taking responsibility over the correct operation of your entire device.