

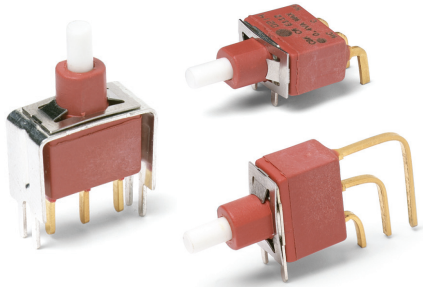

E010 Series Sealed Momentary Pushbutton Switches

Pushbutton
A



Features/Benefits

- Process sealed, withstands soldering and cleaning
- Long life contact design
- Snap-fitting plunger available, accepts a variety of caps
- RoHS compliant models available

Typical Applications

- Instrumentation
- Telecommunications and networking equipment
- Computers and peripherals



Models Available

Specifications

CONTACT RATING: Q contact material: 4 AMPS @ 125 V AC or 28 V DC. See page A-50 for additional ratings.

ELECTRICAL LIFE: 40,000 make-and-break cycles at full load.

CONTACT RESISTANCE: Below 20 mΩ typ. initial @ 2-4 V DC, 100 mA, for both silver and gold plated contacts.

INSULATION RESISTANCE: 10⁹Ω min.

DIELECTRIC STRENGTH: 1000 Vrms min. @ sea level.

OPERATING TEMPERATURE: -30°C to 75°C.

CAP INSTALLATION FORCE: 10 lbs. max. permissible.

SOLDERABILITY: Per MIL-STD-202F method 208D, or EIA RS-186E method 9 (1 hour steam aging).

NOTE: Any models supplied with P, Q, B or G contact material are RoHS compliant.

NOTE: Specifications and materials listed above are for switches with standard options. For information on specific and custom switches, consult Customer Service Center.

Materials

CASE & BUSHING: Glass filled nylon 6/6, flame retardant (UL 94V-0).

PLUNGER: Glass filled nylon or glass filled polyester (PBT) (UL 94V-0), with internal o-ring seal standard.

SWITCH SUPPORT: Brass or steel, matte-tin plated.

SWITCH SUPPORT RETAINER: Stainless steel.

END CONTACTS: Q contact material: Coin silver, silver plated. See A-50 for additional ratings.

CENTER CONTACTS & ALL TERMINALS: Q contact material: Copper alloy, silver plated. See page A-50 for additional ratings.

TERMINAL SEAL: Epoxy.

HARDWARE: Nut & locking ring-Brass, nickel plated. Lockwasher-Steel, nickel plated.

Build-A-Switch

To order, simply select desired option from each category and place in the appropriate box. Available options are shown and described on pages A-47 thru A-51. For additional options not shown in catalog, consult Customer Service Center. All models are process sealed to withstand machine soldering temperatures and pressure wash cleaning methods.

<p>Switch Function _____</p> <p>E112 SPDT On-Mom.</p> <p>Plunger _____</p> <p>S .222" high</p> <p>L .338" high</p> <p>M .331" high, snap-fitting</p> <p>Bushing _____</p> <p>D1 Unthreaded</p> <p>Y Threaded, keyway</p> <p>Terminations _____</p> <p>A Right angle, PC thru-hole</p> <p>AV2 Vertical right angle, PC thru-hole</p> <p>C PC Thru-hole</p> <p>A3 Right angle, snap-in, PC thru-hole</p> <p>AV3 Vertical right angle, snap-in, PC thru-hole</p> <p>V3 .460" high, V-bracket</p> <p>V4 .630" high, V-bracket</p> <p>V6 .460" high, V-bracket</p> <p>V8 .953" high, V-bracket</p> <p>V31 .460" high, snap-in V-bracket</p> <p>V81 .953" high, snap-in V-bracket</p> <p>V91 1.150" high, snap-in V-bracket</p> <p>W .750" long, wire wrap</p> <p>Z Solder lug</p> <p>Contact Material _____</p> <p>B Gold</p> <p>P Gold, matte-tin</p> <p>Q Silver</p> <p>G Gold over silver</p> <p>Seal _____</p> <p>E Epoxy</p>	
---	--



17 Mar 22

Dimensions are shown: Inches (mm)
Specifications and dimensions subject to change

E010 Series Sealed Momentary Pushbutton Switches



A
Pushbutton

SWITCH FUNCTION

NO. POLES	MODEL NO.	SWITCH FUNCTION		CONNECTED TERMINALS		SCHEMATIC
		POS. 1	POS. 2	POS. 1	POS. 2	
SP	E112	ON	MOM.	2-1	2-3	SPDT NC 1 ● 2 (COMM) ● 3 NO
<p>SPDT</p> <p>Part number shown: E112SD1CQE</p>						

MOM. = Momentary

All models with all options when ordered with G or Q contact material.

PLUNGER

S .218" HIGH

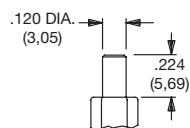

Standard with D1 bushing (as shown).

† Subtract .100 (2,54) from plunger length when ordered with Y bushing.

L .338" HIGH

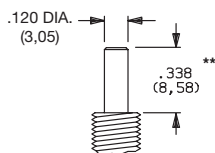

Standard with Y bushing (as shown).

** Add .100 (2,54) from plunger length when ordered with D1 bushing.

M .331" HIGH, SNAP-FITTING

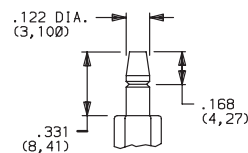

NOTE: Caps available for all plunger options, see pages A-50 and A-51.

BUSHING

D1 UNTHREADED

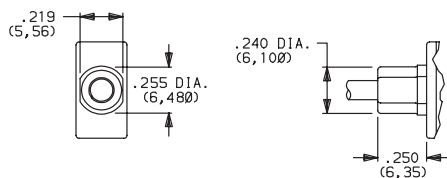

S plunger standard with D1 bushing.

Y THREADED, KEYWAY

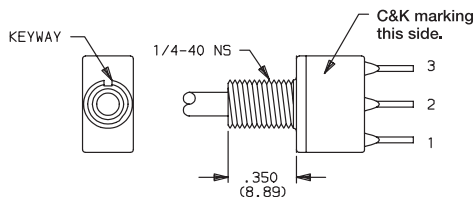

L plunger standard with Y bushing. Available only with C, Z terminations.

Hardware: One dress nut part number 299D01201, one hex nut and lockwasher supplied standard.

Withstands 4 in./lbs. without distortion.

PANEL MOUNTING

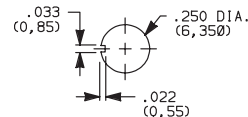

NOTE: Internal o-ring actuator seal standard for all bushing options.

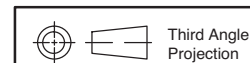

Third Angle Projection

Dimensions are shown: Inches (mm)
Specifications and dimensions subject to change



17 Mar 22



E010 Series Sealed Momentary Pushbutton Switches

TERMINATIONS



Pushbutton

A

C PC THRU-HOLE

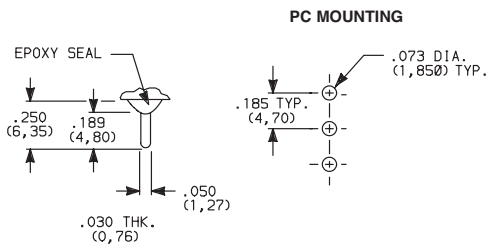

SPDT

Z SOLDER LUG

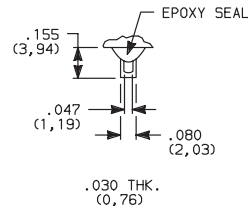

SPDT *Not available with P contact materials.*

W WIRE WRAP

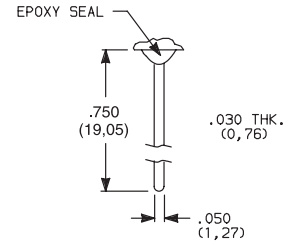

SPDT

A RIGHT ANGLE, PC THRU-HOLE

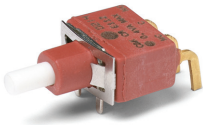

E112SD1ABE
SPDT

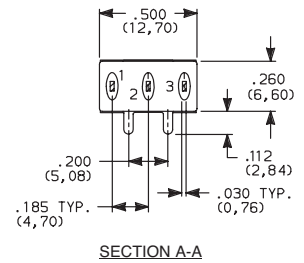
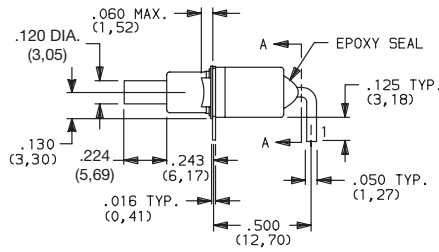
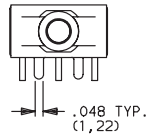

A3 RIGHT ANGLE, SNAP-IN, PC THRU-HOLE

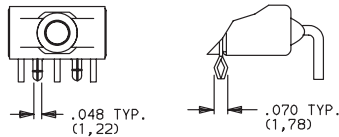

AW RIGHT ANGLE, EXTENDED, PC THRU-HOLE

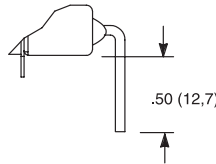

PC MOUNTING

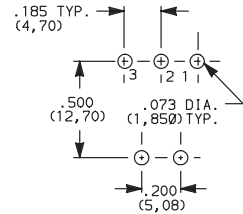

NOTE: Terminal bend radii and lead-in manufacturing option. Available with D1 bushing only.

AV2 VERTICAL RIGHT ANGLE, PC THRU-HOLE, .150" PITCH

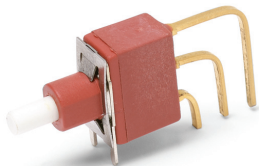

E112SD1AV2BE
SPDT

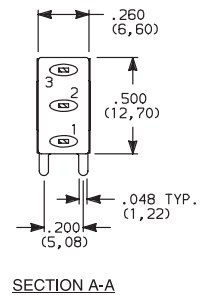
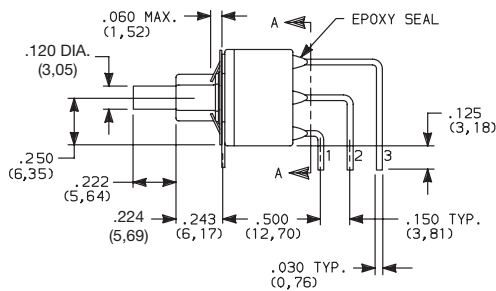
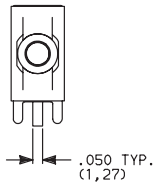

AV3 VERTICAL RIGHT ANGLE, SNAP-IN, PC THRU-HOLE, .150" PITCH

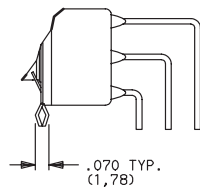
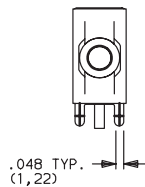

PC MOUNTING

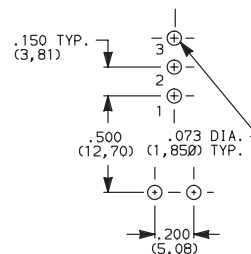

NOTE: Terminal bend radii and lead-in manufacturing option. Available with D1 bushing only.



17 Mar 22

Dimensions are shown: Inches (mm)
Specifications and dimensions subject to change

www.ckswitches.com

E010 Series Sealed Momentary Pushbutton Switches

TERMINATIONS

V3, V4 VERTICAL MOUNT, V-BRACKET

V31, V91 VERTICAL MOUNT, V-BRACKET, SNAP-IN

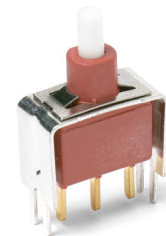
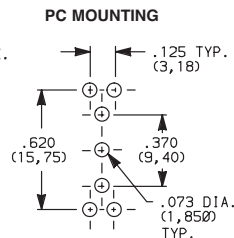
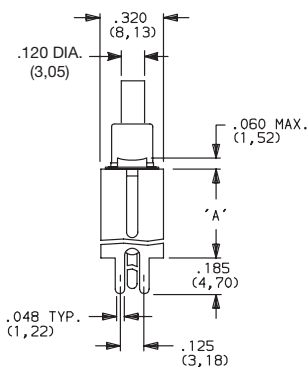
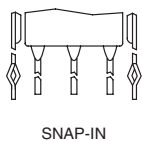
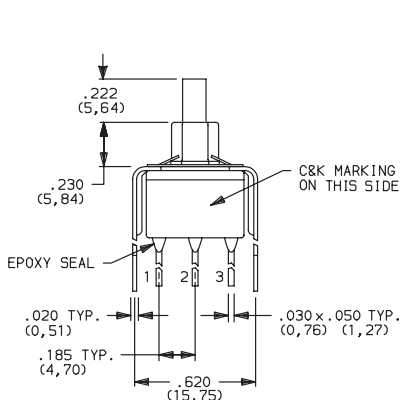

E112SD1_BE SPDT

OPTION CODE	DIM 'A'
V3, V31	.460 (11,68)
V4	.630 (16,00)
V91	1.150 (29,21)

NOTE: Available with D1 bushing only.

V6, V8 VERTICAL MOUNT, V-BRACKET

V81 VERTICAL MOUNT, V-BRACKET, SNAP-IN

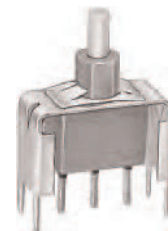
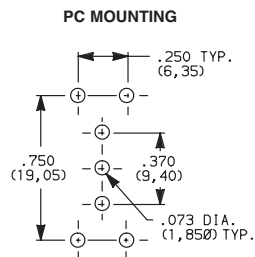
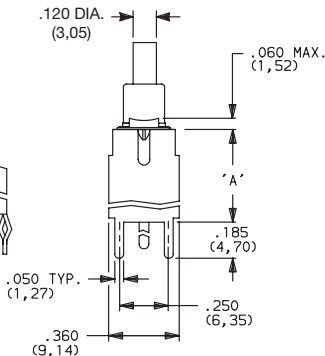
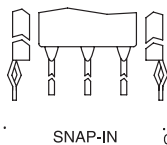
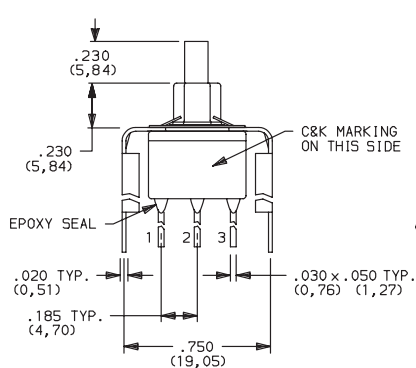

E112SD1_BE SPDT

OPTION CODE	DIM 'A'
V6	.460 (11,68)
V8, V81	.953 (24,21)

NOTE: Available with D1 bushing only.

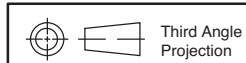

Third Angle Projection



17 Mar 22

Dimensions are shown: Inches (mm)
Specifications and dimensions subject to change



E010 Series Sealed Momentary Pushbutton Switches

Pushbutton
A

CONTACT MATERIAL

OPTION CODE	CONTACT MATERIAL	TERMINAL PLATING	RATINGS	
B	GOLD ¹	GOLD ¹	LOW LEVEL/DRY CIRCUIT	0.4 VA MAX. @ 20 V AC OR DC MAX.
P		MATTE-TIN ⁶		
Q	SILVER ^{4,5}	SILVER ⁵	POWER	4 AMPS @ 125 V AC OR 28 V DC.
G	GOLD OVER SILVER ^{2,3}	GOLD ³	LOW LEVEL/DRY CIRCUIT OR POWER	0.4 VA MAX. @ 20 V AC OR DC MAX. OR 4 AMPS @ 125 V AC OR 28 V DC.

* Note: See Technical Data section of this catalog for RoHS compliant and compatible definitions and specifications.

- ¹ CONTACTS & TERMINALS: Copper alloy, with gold plate over nickel plate.
- ² END CONTACTS: Coin silver, with gold plate over nickel plate.
- ³ CENTER CONTACTS & ALL TERMINALS: Coin silver, with gold plate over nickel plate.
- ⁴ END CONTACTS: Coin silver, silver plated.
- ⁵ CENTER CONTACTS & ALL TERMINALS: Copper alloy, silver plated.
- ⁶ TERMINALS: Copper alloy, with matte-tin over nickel plate.

NOTE: Any models supplied with P, Q, B or G contact material are RoHS compliant.

All models with all options when ordered with G or Q contact material.

B contact material standard with all terminations except C, Z.

Q contact material standard with C, Z terminations.

P contact materials not available with Z terminations.

SEAL

E EPOXY SEAL

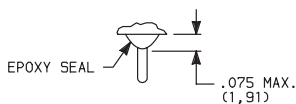

AVAILABLE HARDWARE

Cap

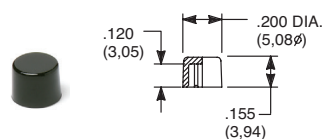

PART NO.
708901000 WHITE
708902000 BLACK
708903000 RED

Material: Nylon
 Finish: Gloss

Cap

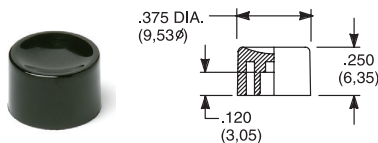

PART NO.
752701000 WHITE
752702000 BLACK
752703000 RED

Material: Nylon
 Finish: Gloss

Cap

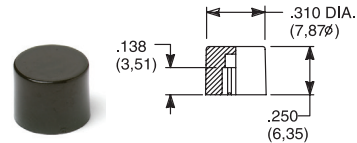

PART NO.
801801000 WHITE
801802000 BLACK
801803000 RED

Material: Nylon
 Finish: Gloss

NOTE: Additional nuts, locking rings and lockwashers available separately, see section "Technical Data and Additional Hardware".
 Other cap colors available, consult Customer Service Center.

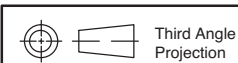

Third Angle
 Projection



17 Mar 22

Dimensions are shown: Inches (mm)
 Specifications and dimensions subject to change

E010 Series Sealed Momentary Pushbutton Switches

AVAILABLE HARDWARE

Cap, Snap-fitting plunger

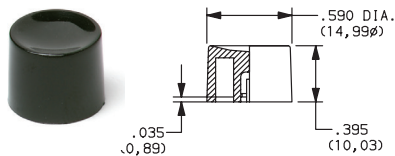

PART NO.

- 452D01000** WHITE
- 452D02000** BLACK
- 452D03000** RED

Material: Nylon
Finish: Gloss

Cap, Snap-fitting plunger

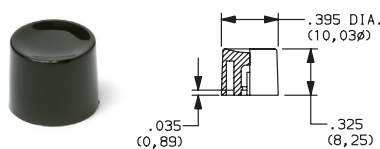

PART NO.

- 894101000** WHITE
- 894102000** BLACK
- 894103000** RED

Material: Nylon
Finish: Gloss

Cap

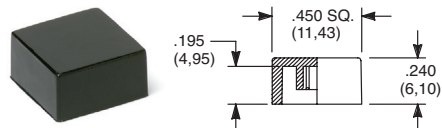

PART NO.

- 484601000** WHITE
- 484602000** BLACK
- 484603000** RED

Material: Nylon
Finish: Gloss

PART NO.

- 798201000** WHITE
- 798202263** BLACK
- 798203000** RED

Material: Nylon
Finish: Matte

NOTE: Additional nuts, locking rings and lockwashers available separately, see section "Technical Data and Additional Hardware".
Other cap colors available, consult Customer Service Center.

Frames snap into panel opening and are independent from switch mounting. Accurate positioning of the PC mounted switch relative to the panel opening is necessary to provide proper clearance between actuator and frame. Available in two basic styles and four panel thicknesses .047-.125 in. Material: Nylon. Finish: Matte.

TYPICAL APPLICATION

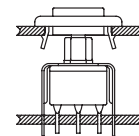

.090" (2,29) PANEL THK. .125" (3,18) PANEL THK.

PART NO.

432702263

PART NO.

432802263 BLACK

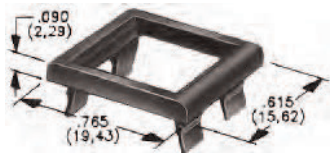

PANEL MOUNTING

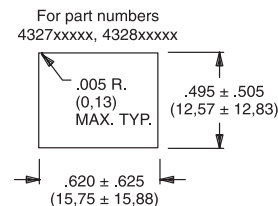
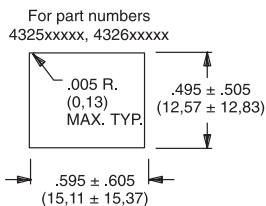

Panel Inserts

Above frames (part nos. 432XXXXXX) are also available with insert which accepts LED for indicator light assembly. Order insert separately from frame. Blank insert panel (without hole for LED) also available. **LED not included.**

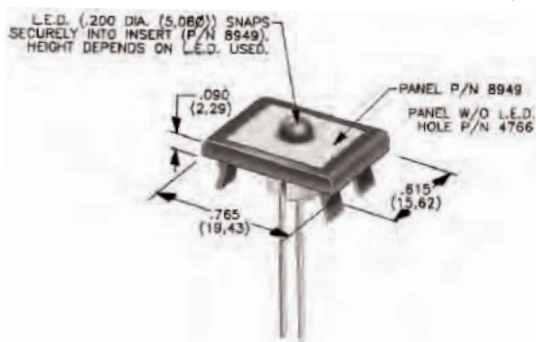

PANEL INSERT
WITH HOLE FOR LED

PART NO.
894902000

BLANK PANEL INSERT
WITHOUT HOLE FOR LED

PART NO.
476602000 BLACK

Special colors, custom markings available, consult Customer Service Center.

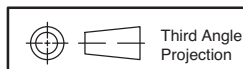

Dimensions are shown: Inches (mm)
Specifications and dimensions subject to change