

# DATA SHEET

## CARBON FILM RESISTORS

Flameproof  
FCR Series

±2%, ±5%

1/4W to 3W

RoHS compliant & Halogen Free



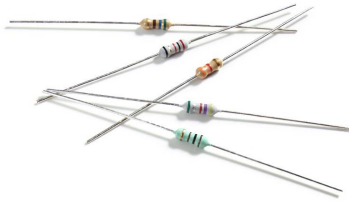

**ORDERING INFORMATION**

Part number of the flameproof carbon film resistor are identified by the series, power rating, tolerance, packing, temperature coefficient, forming and resistance value.

**APPLICATIONS**

- All general purpose applications
- Power applications

**FEATURES**

- Wide resistance range
- High stability
- Flameproof coating equivalent to UL-94V-0
- RoHS compliant & halogen-free

**PART NUMBER**

<u>FCR</u>	<u>200</u>	<u>J</u>	<u>T</u>	<u>-</u>	<u>73-</u>	<u>100R</u>
(1)	(2)	(3)	(4)	(5)	(6)	(7)

**(1) SERIES**

FCR Series

**(2) POWER RATING**

-25 = 1/4W	100 = 1W
50S = 1/2W	2WS = 2W
-50 = 1/2W	200 = 2W
1WS = 1W	3WS = 3W

**(3) TOLERANCE**

G = ±2%	J = ±5%
---------	---------

**(4) PACKAGING**

R = Reel Pack	B = Bulk
T = Box Pack	

**(5) TEMPERATURE COEFFICIENT OF RESISTANCE**

- = Based on spec , refer to page 4 Table 2 .

**(6) FORMING**

26- = 26mm	FK = FK Type
52- = 52.4mm	FFK = F-form Kink
73- = 73mm	FKK = FKK Type
52C = 52.4mm, Φd =0.5±0.02mm	FT = FT Type Forming
M = M-Type Forming	PN = PANAsert
MB = M-form W/flat	AV = AVIsert
F = F Type	

**(7) RESISTANCE VALUE**

E24 Series  
 Example:  
 100R = 100Ω, 10K = 10,000Ω, 1M = 1,000,000Ω

**DIMENSIONS**

Unit: mm

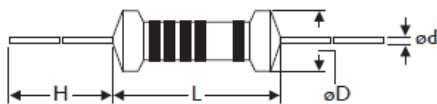

Normal	Miniature	L	$\psi D$	H	$\psi d$
FCR -25	FCR 50S	6.3 ± 0.5	2.4 ± 0.2	28 ± 2.0	0.55 ± 0.05
FCR -50	FCR 1WS	9.0 ± 0.5	3.3 ± 0.3	26 ± 2.0	0.55 ± 0.05
FCR 100	FCR 2WS	11.5 ± 1.0	4.5 ± 0.5	35 ± 2.0	0.8 ± 0.05
FCR 200	FCR 3WS	15.5 ± 1.0	5.0 ± 0.5	33 ± 2.0	0.8 ± 0.05

**DERATING CURVE**

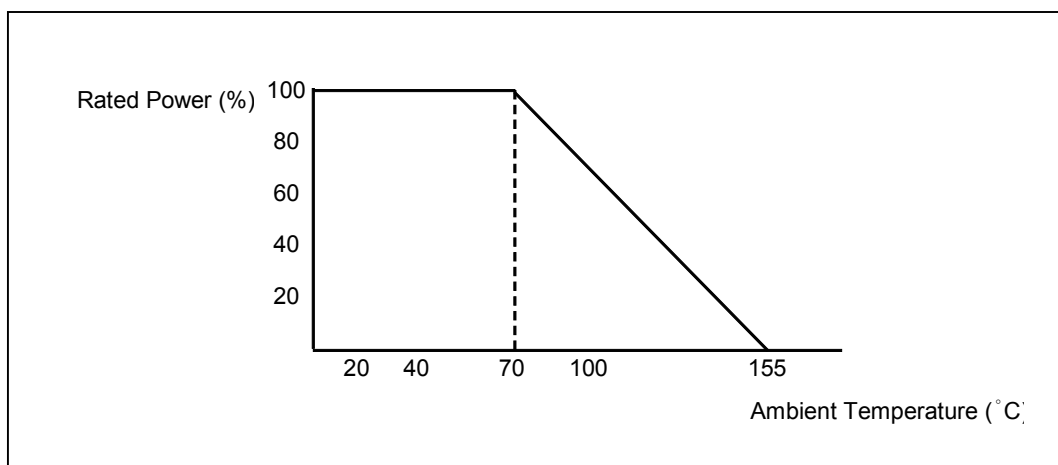

**ELECTRICAL CHARACTERISTICS**

**TABLE 1**

CHARACTERISTICS	FCR-25	FCR50S	FCR-50	FCR1WS	FCR100	FCR2WS	FCR200	FCR3WS
Power Rating at 70 °C	1/4W	1/2W	1/2W	1W	1W	2W	2W	3W
Maximum Working Voltage	250V	300V	350V	400V	500V	500V	500V	500V
Maximum Overload Voltage	500V	600V	700V	800V	1000V	1000V	1000V	1000V
Voltage Proof on Insulation	400V	400V	500V	500V	500V	500V	500V	500V
Resistance Range	1Ω ~ 10MΩ for E24 series value							
Operating Temp. Range	- 55°C to +155°C							
Temperature Coefficient	See table 2							

Note: For resistance value out of above range is by request.

**TABLE 2 TEMPERATURE COEFFICIENT**

TYPE	Temp. Coefficient ppm/°C		
	Under 100KΩ	100K ~ 1MΩ	1M ~ 10MΩ
FCR100, FCR200, FCR2WS FCR3WS	± 350	-500~0	-1500~0
FCR-25 , FCR-50,FCR50S , FCR1WS	- 500 ~ + 350	-700~0	-1500~0

**TEST AND REQUIRMENTS**

TEST	TEST METHOD	PROCEDURE	APPRAISE
Short Time Overload	IEC 60115-1 4.13	2.5 times RCWV for 5 sec.(Not more than maximum overload voltage)	±0.75%+0.05Ω
Voltage Proof on Insulation	IEC 60115-1 4.7	In V-Block for 60 sec. test voltage as above table	No Breakdown
Temperature Coefficient	IEC 60115-1 4.8	Between -55°C to +155°C	By Type
Insulation Resistance	IEC 60115-1 4.6	In V-Block for 60 sec.	>1,000MΩ
Solderability	IEC 60115-1 4.17	245±5°C for 3±0.5 Sec.	95% Min. coverage
Solvent Resistance of Marking	IEC 60115-1 4.30	IPA for 5±0.5 Min. with ultrasonic	No deterioration of coatings and markings
Robustness of Terminations	IEC 60115-1 4.16	Direct load for 10 Sec. in the direction of the terminal leads	≥2.5Kg(24.5N)
Periodic-pulse Overload	IEC 60115-1 4.39	4 times RCWV(or Umax., whichever less) 10,000 cycles (1 Sec. on, 25 Sec.off)	±1.0%+0.05Ω
Damp Heat Steady State	IEC 60115-1 4.24	40±2°C,90-95% RH for 56 days, loaded with 0.1 times RCWV (or Umax., whichever less)	±3.0%+0.05Ω
Endurance at 70°C	IEC 60115-1 4.25	70±2°C at RCWV(or Umax., whichever less) for 1,000 Hr.(1.5 Hr.on,0.5 Hr. off)	±3.0%+0.05Ω
Temperature Cycling	IEC 60115-1 4.19	-55°C → Room Temp. → +155°C → Room Temp.(5 cycles)	±1.0%+0.05Ω
Resistance to Soldering Heat	IEC 60115-1 4.18	260±3°C for 10±1 Sec., immersed to a point 3±0.5mm from the body	±1.0%+0.05Ω
Accidental Overload Test	IEC 60115-1 4.26	4 times RCWV(or Umax., whichever less) for 1 Min.	No evidence of flaming or arcing

Note:

**RCWV (Rated Continuous Working Voltage):**

The DC or AC (rms) continuous working voltage corresponding to the rated power is determined by the following formula:

$V = \sqrt{(P \times R)}$   
 or max. working voltage whichever is less

Where

V=Continuous rated DC or  
 AC (rms) working voltage (V)

P=Rated power (W)

R=Resistance value ( $\Omega$ )

**AXIAL / REEL TAPE SPECIFICATION**

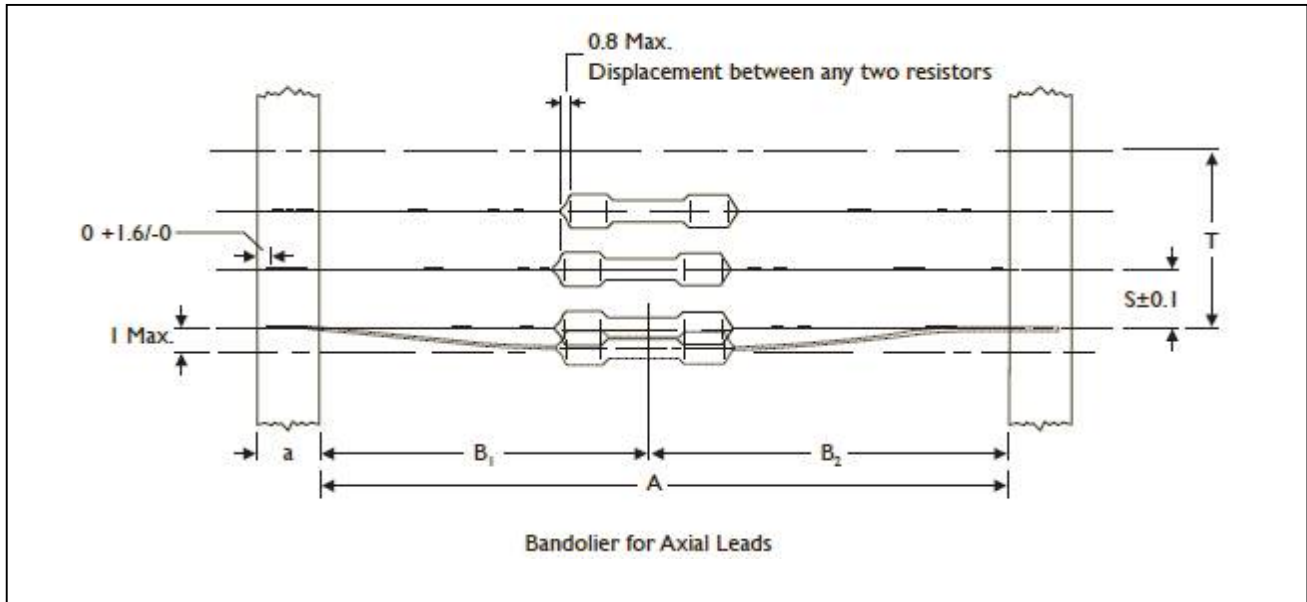

Unit: mm

Normal	Miniature	a	A	B1-B2 (Max.)	S (spacing)	T (max. deviation of spacing)
FCR-25	FCR50S	6 ± 0.5	52.4 ± 1.5	1.2	5	
			26.0 ± 1.5	1		
FCR-50	FCR1WS	6 ± 0.5	52.4 ± 1.5	1.2	5	
FCR100	FCR2WS	6 ± 0.5	73.0 ± 1.5	1.5	5	1 mm per 10 spacing, 0.5 mm per 5 spacing,
			52.4 ± 1.5	1.2		
FCR200	FCR3WS	6 ± 0.5	73.0 ± 1.5	1.5	10	
			52.4 ± 1.5	1.2		

**TAPE ON REEL PACKING**

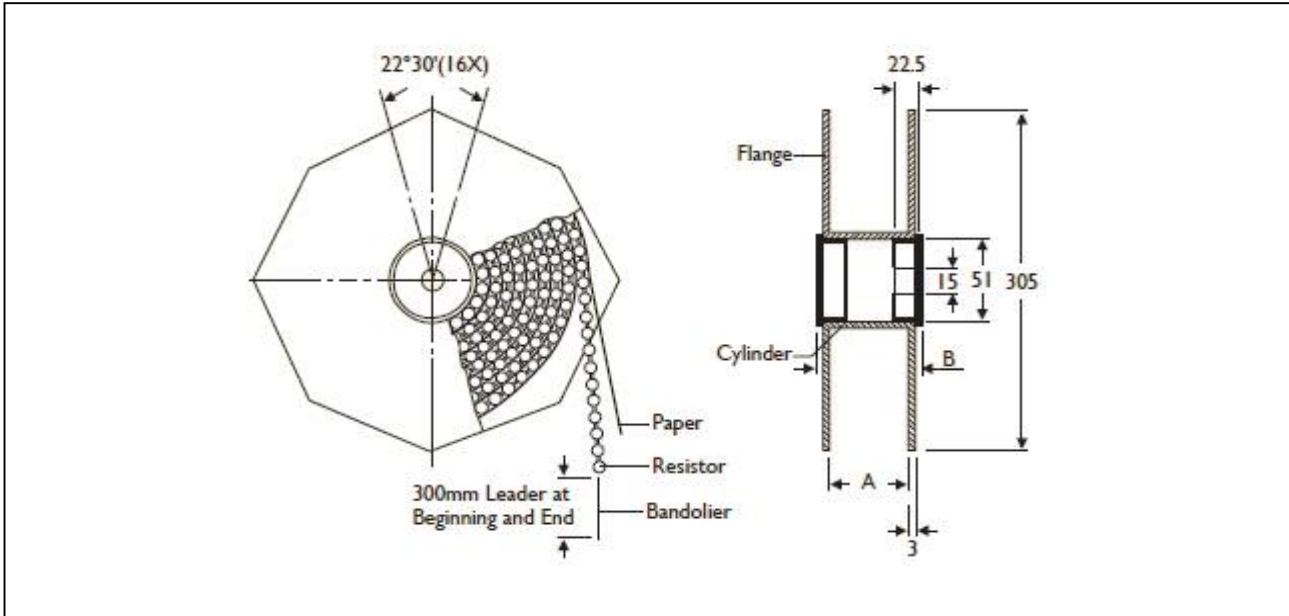

TYPE Unit: mm/piece

Normal	Miniature	Across Flange(A)	B	Quantity Per Reel
FCR-25	FCR50S	66.5	75.5	5,000
FCR-50	FCR1WS	66.5	75.5	2,500
FCR100	FCR2WS	87	96	2,000
FCR200	FCR3WS	87	96	1,000

**TAPE ON BOX PACKING**

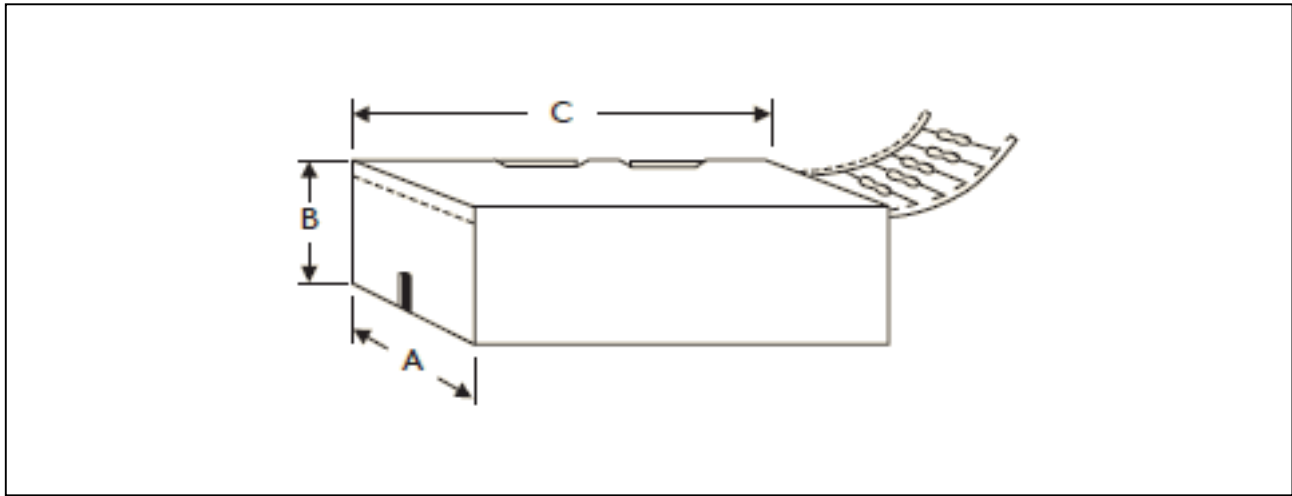

TYPE		DIMENSIONS			Unit: mm/piece
Normal	Miniature	A	B	C	Quantity Per Box
FCR-25	FCR50S	48	102	255	5,000
FCR-25	FCR50S	81	104	260	5,000
FCR-50	FCR1WS	73	45	258	1,000
FCR100	FCR2WS	81	91	260	1,000
FCR100	FCR2WS	103	78	260	1,000
FCR200	FCR3WS	81	91	260	1,000
FCR200	FCR3WS	103	94	260	1,000

**BULK PACKING**

Normal	Miniature	Piece/Per Inner Box	Bag/Per Inner Box	Piece Per Bag
CFR-25	CFR50S	10,000	10	1,000
CFR-50	CFR1WS	5,000	5	1,000
CFR-100	CFR2WS	2,000	4	500
CFR200	CFR3WS	1,000	2	500

**FORMING**

**M TYPE**

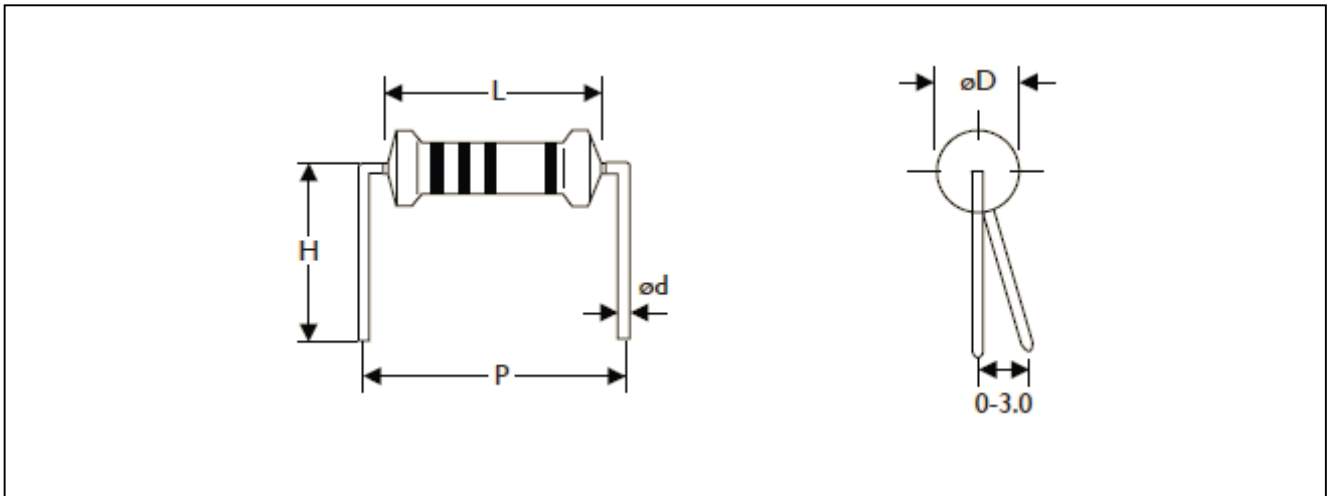

TYPE		DIMENSIONS					Unit: mm	
Normal	Miniature	L	ψD	ψd	P	H		
FCR-25	FCR50S	6.3 ± 0.5	2.4 ± 0.2	0.55 ± 0.05	10.0 ± 1	10.0 ± 1		
FCR-50	FCR1WS	9.0 ± 0.5	3.3 ± 0.3	0.55 ± 0.05	12.5 ± 1	10.0 ± 1		
FCR100	FCR2WS	11.5 ± 1.0	4.5 ± 0.5	0.8 ± 0.05	15.0 ± 1	12.5 ± 1		
FCR200	FCR3WS	15.5 ± 1.0	5.0 ± 0.5	0.8 ± 0.05	20.0 ± 1	15.0 ± 1		

**MB TYPE**

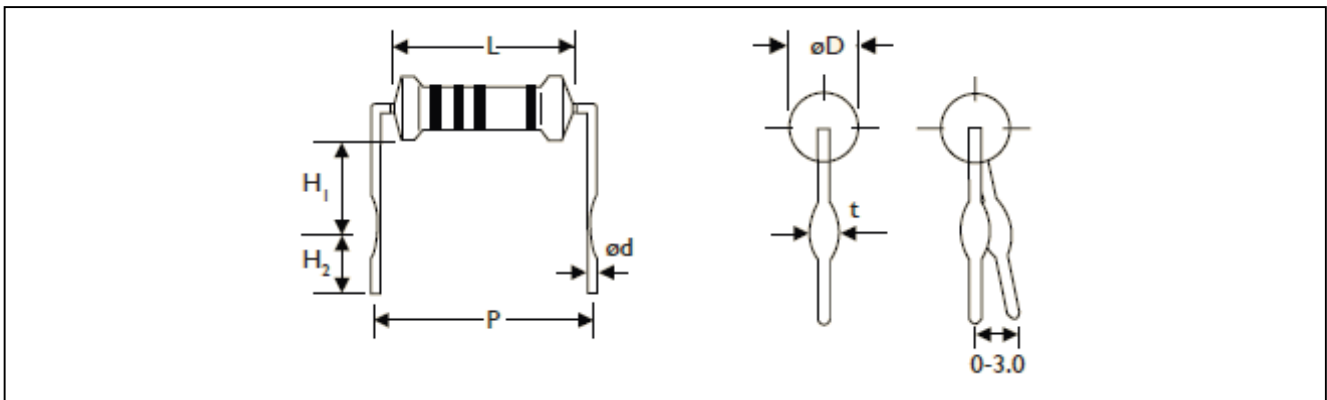

TYPE		DIMENSIONS							Unit: mm	
Normal	Miniature	L	ψD	ψd	P	H1	H2	t		
FCR-25	FCR50S	6.3 ± 0.5	2.4 ± 0.2	0.55 ± 0.05	10.0 ± 1	6.0 ± 1	5.0 ± 1	1.2 ± 0.2		
FCR-50	-	9.0 ± 0.5	3.3 ± 0.3	0.55 ± 0.05	12.5 ± 1	6.0 ± 1	5.0 ± 1	1.2 ± 0.2		
-	FCR1WS	9.0 ± 0.5	3.3 ± 0.3	0.55 ± 0.05	12.5 ± 1	6.0 ± 1	5.0 ± 1	1.4 ± 0.2		
FCR100	FCR2WS	11.5 ± 1.0	4.5 ± 0.5	0.8 ± 0.05	15.0 ± 1	6.0 ± 1	5.0 ± 1	1.4 ± 0.2		
FCR200	FCR3WS	15.5 ± 1.0	5.0 ± 0.5	0.8 ± 0.05	20.0 ± 1	10.0 ± 1	5.0 ± 1	1.4 ± 0.2		



**MHA TYPE**

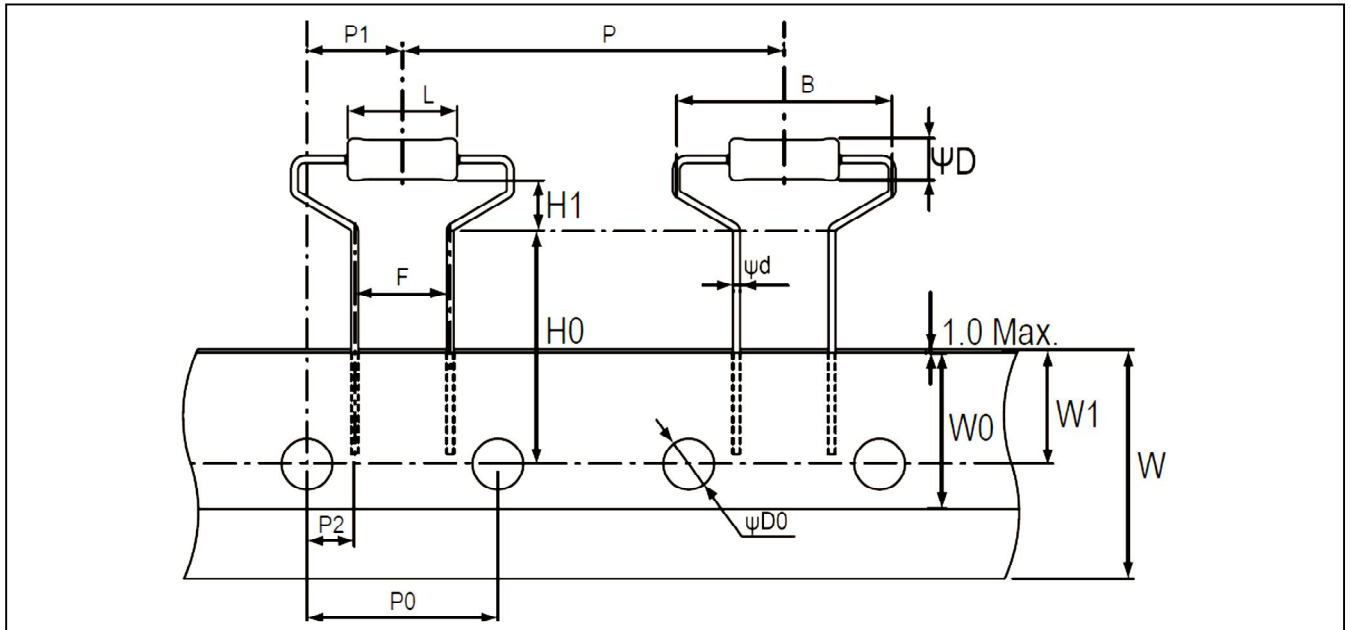

TYPE		DIMENSIONS								Unit: mm
<b>Normal</b>	<b>Miniature</b>	<b>L</b>	<b>ψD</b>	<b>ψd</b>	<b>B</b>	<b>H0</b>	<b>H1</b>	<b>P</b>	<b>P0</b>	
		9.0±0.5	3.3±0.3	0.55±0.05	17.5Max	19.0±1.0	4.0±1.0	30.0±1.0	15.0±0.3	
FCR -50	FCR 1WS	<b>P1</b>	<b>P2</b>	<b>F</b>	<b>W</b>	<b>W0</b>	<b>W1</b>	<b>ψD0</b>		
		7.5±1.0	3.75±0.5	7.5±0.5	18.0±0.5	5.0Min	9.0±0.5	4.0±0.2		

**MHB TYPE**

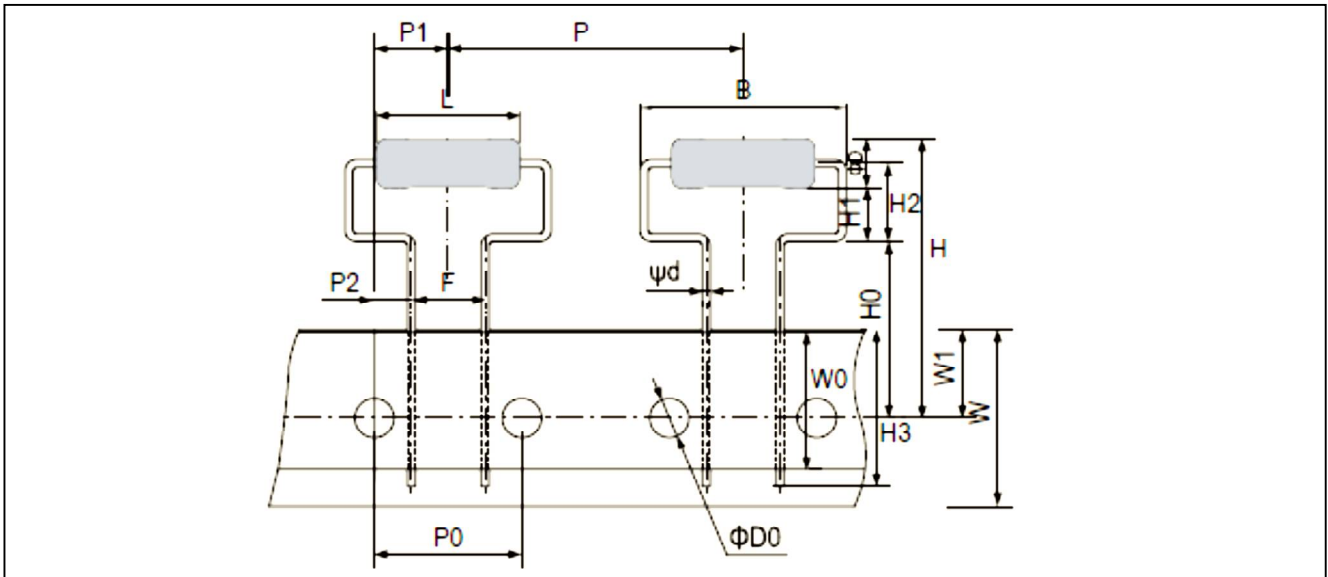

TYPE		DIMENSIONS								Unit: mm
<b>Normal</b>	<b>Miniature</b>	<b>L</b>	<b>ψD</b>	<b>ψd</b>	<b>B</b>	<b>H</b>	<b>H0</b>	<b>H1</b>	<b>H2</b>	<b>H3</b>
		15.5±1.0	5.0±0.5	0.8±0.05	21.0Max.	30Max.	18.0±1.0	5.5(Ref.)	8.0±1.5	16Max.
FCR200	FCR3WS	<b>P</b>	<b>P0</b>	<b>P1</b>	<b>P2</b>	<b>F</b>	<b>W</b>	<b>W0</b>	<b>W1</b>	<b>ψD0</b>
		30.0±1.0	15.0±0.3	7.5±1.0	3.75±0.8	7.5±0.5	18.0±0.5	5.0Min.	9.0±0.5	4.0±0.3

**MHC TYPE**

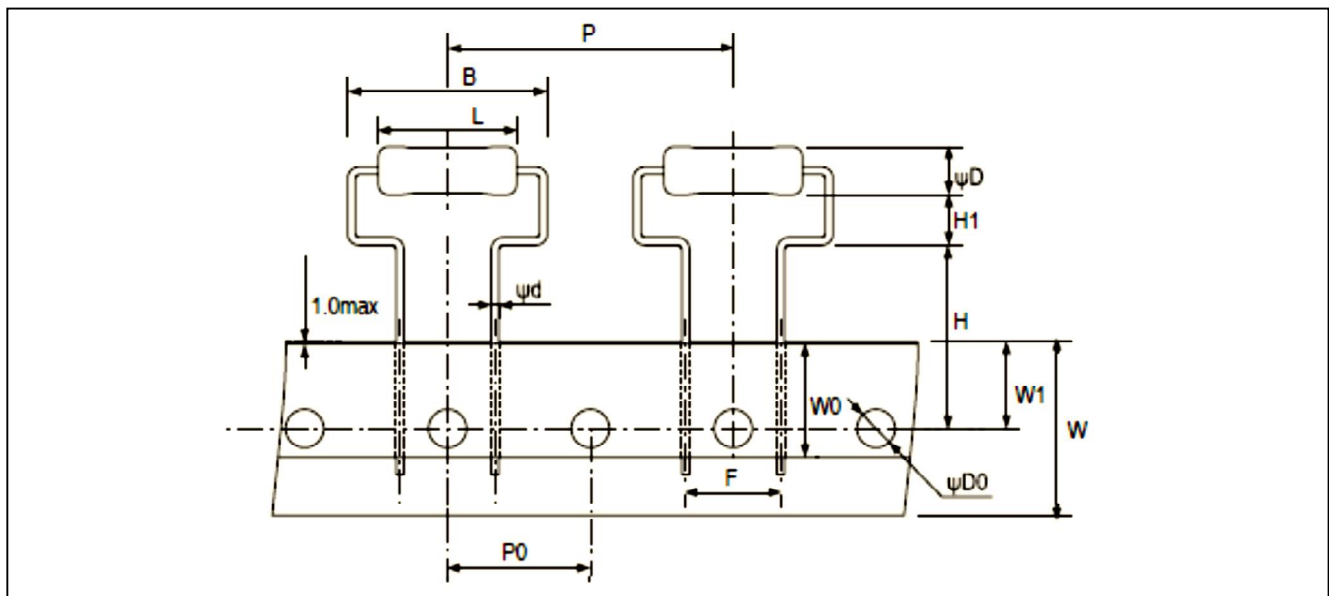

TYPE		DIMENSIONS							Unit: mm
<b>Normal</b>	<b>Miniature</b>	<b>L</b>	<b>ψD</b>	<b>ψd</b>	<b>B</b>	<b>H</b>	<b>H1</b>	<b>P</b>	<b>P0</b>
		15.5±1.0	5.0±0.5	0.8±0.05	21.0Max.	19.0±1.0	5.25±1.0	30.0±1.0	15.0±0.3
FCR200	FCR3WS	<b>F</b>	<b>W</b>	<b>W0</b>	<b>W1</b>	<b>ψD0</b>			
		10.0±0.5	18.0±0.5	5.0Min.	9.0±0.5	4.0±0.2			

**F TYPE**

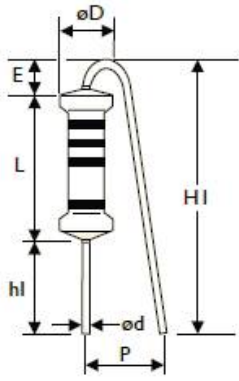

**FK TYPE**

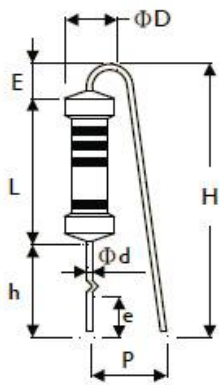

**FFK TYPE**

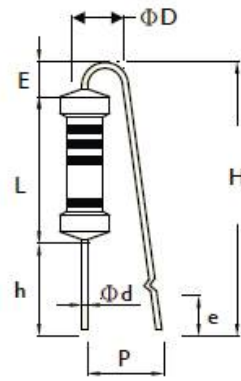

**FKK TYPE**

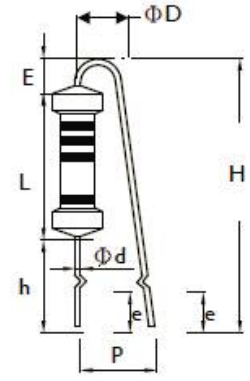

TYPE		DIMENSIONS										Unit: mm
Normal	Miniature	L	ψD	ψd	P	h	H Max.	hl	HI Max.	E Max.	e	
FCR-50	FCR1WS	9.0±0.5	3.3±0.3	0.55±0.05	6±1	8±1	22	5±1	18.5	3.5	3.5±1	
FCR100	FCR2WS	11.5±1	4.5±0.5	0.8±0.05	6±1	8±1	24	5±1	20	3.5	3.5±1	
FCR200	FCR3WS	15.5±1	5.0±0.5	0.8±0.05	8±1	8±1	28	5±1	25	3.5	3.5±1	

**PN TYPE ( Taping Pack )**

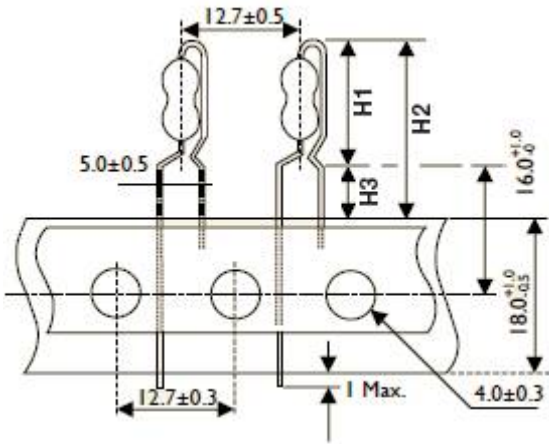

**AV TYPE ( Taping Pack )**

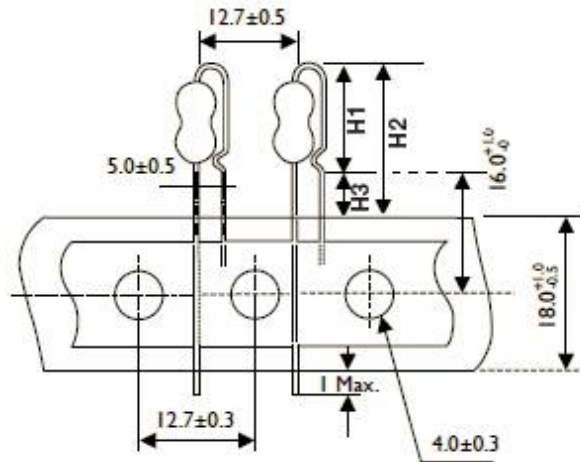

TYPE		DIMENSIONS			Unit: mm
Normal	Miniature	H1 Max.	H2 Max.	H3 Max.	
FCR-25	FCR50S	13	21.5	8.5	
FCR-50	FCR1WS	17	25.5	8.5	
FCR100	FCR2WS	19	27.5	8.5	

TYPE		DIMENSIONS			Unit: mm
Normal	Miniature	H1 Max.	H2 Max.	H3 Max.	
FCR-25	FCR50S	11.5	20	8.5	
FCR-50	FCR1WS	14.5	23	8.5	
FCR100	FCR2WS	17.5	26	8.5	

**FT TYPE ( Taping Pack )**

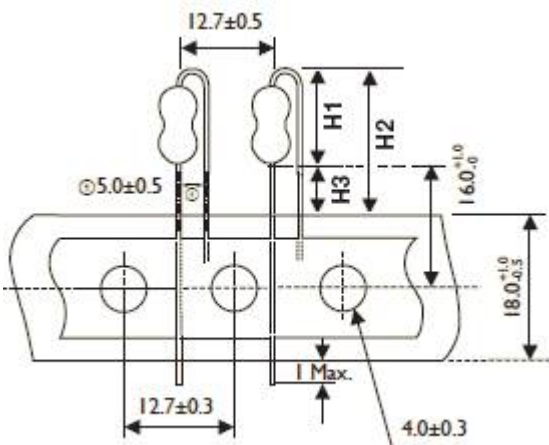

TYPE		DIMENSIONS			Unit: mm
Normal	Miniature	H1 Max.	H2 Max.	H3 Max.	
FCR-25	FCR50S	10	18.5	8.5	
FCR-50	FCR1WS	13	21.5	8.5	
FCR100	FCR2WS	16	24.5	8.5	

**MARKING**



COLOR	1st BAND	2nd BAND	3rd BAND	MULTIPLIER	TOLERANCE
BLACK	0	0	0	1Ω	
BROWN	1	1	1	10Ω	
RED	2	2	2	100Ω	± 2% ( G )
ORANGE	3	3	3	1KΩ	
YELLOW	4	4	4	10KΩ	
GREEN	5	5	5	100K	
BLUE	6	6	6	1MΩ	
VIOLET	7	7	7	10MΩ	
GREY	8	8	8	0.001Ω	
WHITE	9	9	9	0.0001Ω	
GOLD				0.1Ω	± 5 % ( J )
SILVER				0.01Ω	

**REVISION HISTORY**

REVISION	DATE	CHANGE NOTIFICATION	DESCRIPTION
Version 0	Aug.2, 2021	-	- First issue of this specification

*“ Yageo reserves all the rights for revising the content of this datasheet without further notification, as long as the products itse lf are unchanged. Any product change will be announced by PCN.”*

## **LEGAL DISCLAIMER**

Yageo, its distributors and agents (collectively, "Yageo"), hereby disclaims any and all liabilities for any errors, inaccuracies or incompleteness contained in any product related information, including but not limited to product specifications, datasheets, pictures and/or graphics. Yageo may make changes, modifications and/or improvements to product related information at any time and without notice.

Yageo makes no representation, warranty, and/or guarantee about the fitness of its products for any particular purpose or the continuing production of any of its products. To the maximum extent permitted by law, Yageo disclaims (i) any and all liability arising out of the application or use of any Yageo product, (ii) any and all liability, including without limitation special, consequential or incidental damages, and (iii) any and all implied warranties, including warranties of fitness for a particular purpose, non-infringement and merchantability.

Yageo statements regarding the suitability of products for certain types of applications are based on Yageo's knowledge of typical operating conditions for such types of applications in a generic nature. Such statements are neither binding statements of Yageo nor intended to constitute any warranty concerning the suitability for a specific customer application or use. They are intended for use only by customers with requisite knowledge and experience for determining whether Yageo products are the correct products for their application or use. In addition, unpredictable and isolated cases of product failure may still occur, therefore, customer application or use of Yageo products which requires higher degree of reliability or safety, shall employ additional protective safeguard measures to ensure that product failure would not result in personal injury or property damage.

Yageo products are not designed for application or use in medical, life-saving, or life-sustaining devices or for any other application or use in which the failure of Yageo products could result in personal injury or death. Customers using or selling Yageo products not expressly indicated for above-mentioned purposes shall do so at their own risk and agree to fully indemnify Yageo and hold Yageo harmless.

Information provided here is intended to indicate product specifications only. Yageo reserves all the rights for revising this content without further notification, as long as products are unchanged. Any product change will be announced by PCN.