

Part Number: D318020

Electrical Specifications

| | |
|------------------------|-----------------|
| Frequency Range (GHz): | 8.0 – 20.0 |
| Isolation (dB): | 15 MIN |
| Insertion Loss (dB): | 1.0 MAX |
| VSWR: | 1.45:1 MIN |
| Forward Power (W): | 10 AVG 30 PK |
| Reflective Power (W): | 2 AVG |

Mechanical/Environmental Specifications

| | |
|-------------------|----------------------------|
| Connector Type: | SMA |
| Connector Body: | Passivated stainless steel |
| Connector Pin: | Gold plated copper |
| Load Body: | Brass |
| Magnetic Shunt: | Nickel plated CRS |
| Operational Temp: | -10°C to +85°C |
| Weight (oz) | 0.9 MAX |

D318020 Dimensions

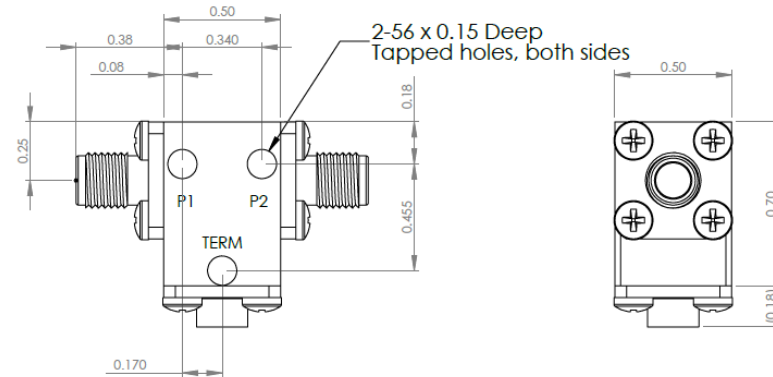

D318020-3 Dimensions

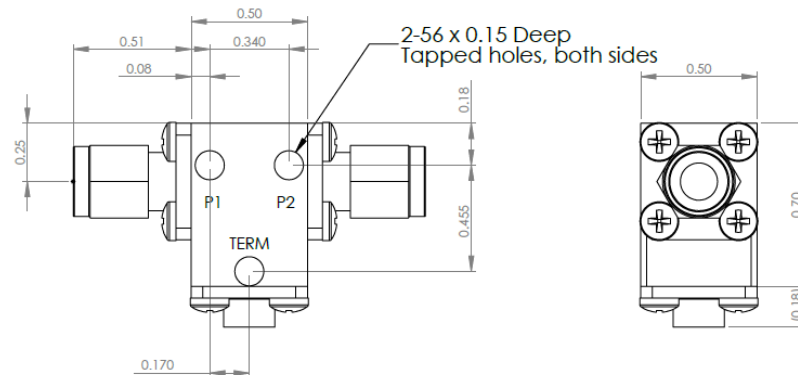

Dimensions are in inches
Tolerance

XX ±0.03
XXX ±0.010

| Type of Device | PN Suffix | Connector Configuration Input / Output | PN Example |
|---|-----------|---|------------|
| Single and Dual Junction Isolator, 2-Port Device | N/A | Female / Female | D318020 |
| | -1 | Male / Female | D318020-1 |
| | -2 | Female / Male | D318020-2 |
| | -3 | Male / Male | D318020-3 |



MEASURED DATA

Part Number: D3I8020, +25°C

