

ANGELETTE-M2

~35° medium beam

TECHNICAL SPECIFICATIONS:

Dimensions	Ø 110.0 mm
Height	57.3 mm
Fastening	socket
ROHS compliant	yes ⓘ

MATERIAL SPECIFICATIONS:

Component	Type	Material	Colour	Finish	Coating
ANGELETTE-M2	Reflector	PC	metal		

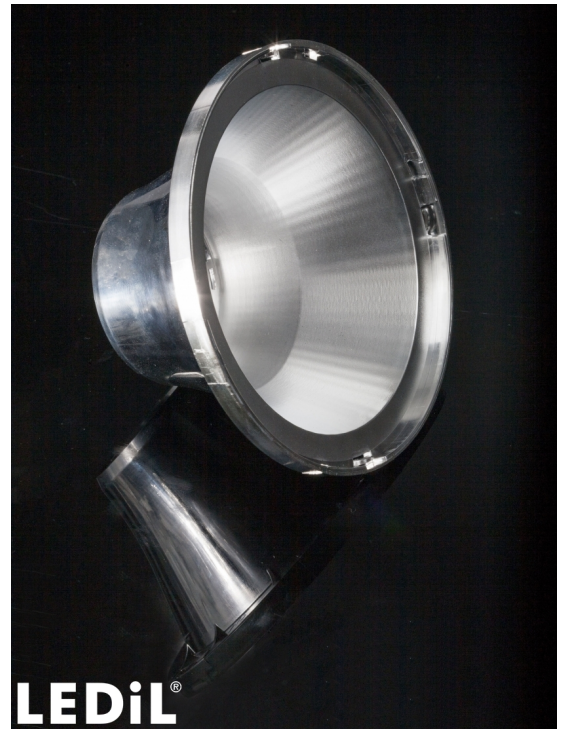





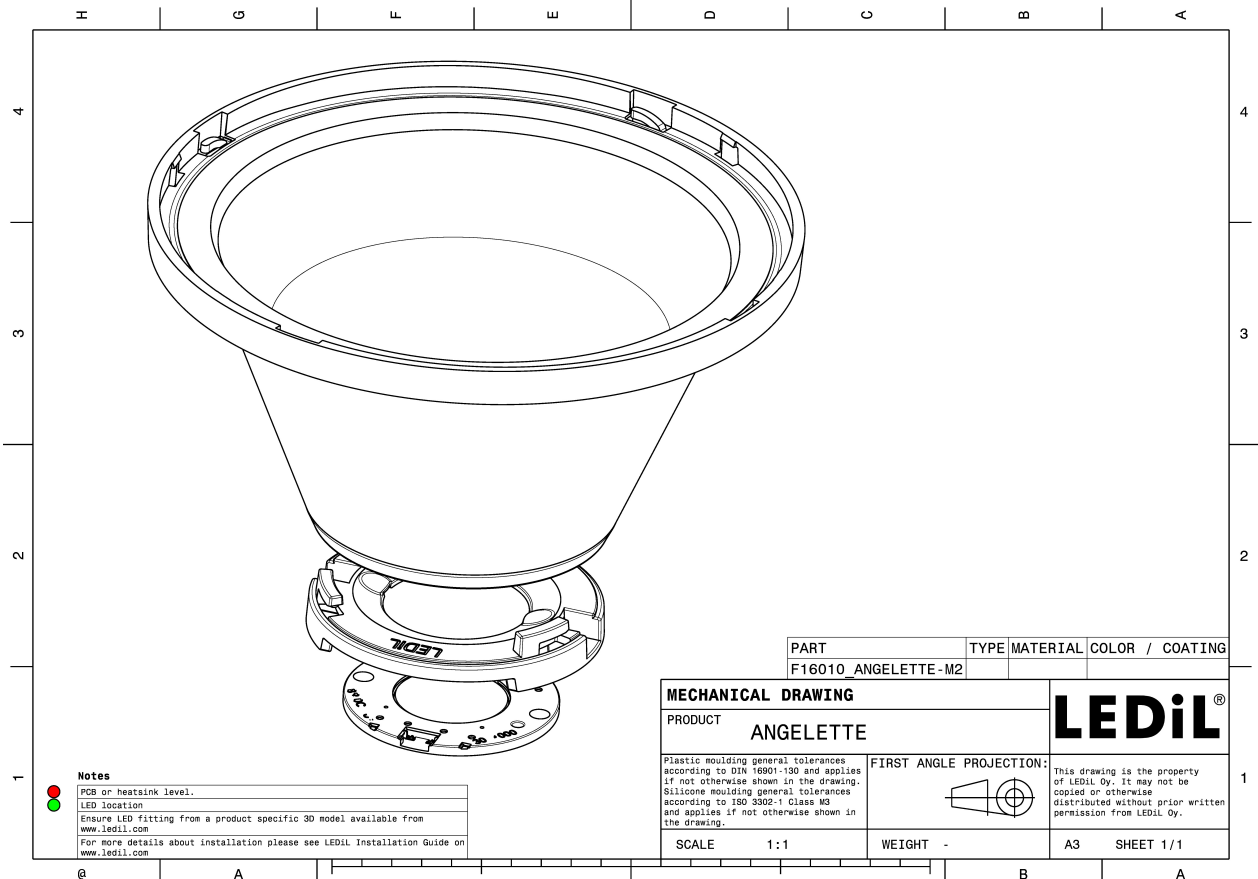
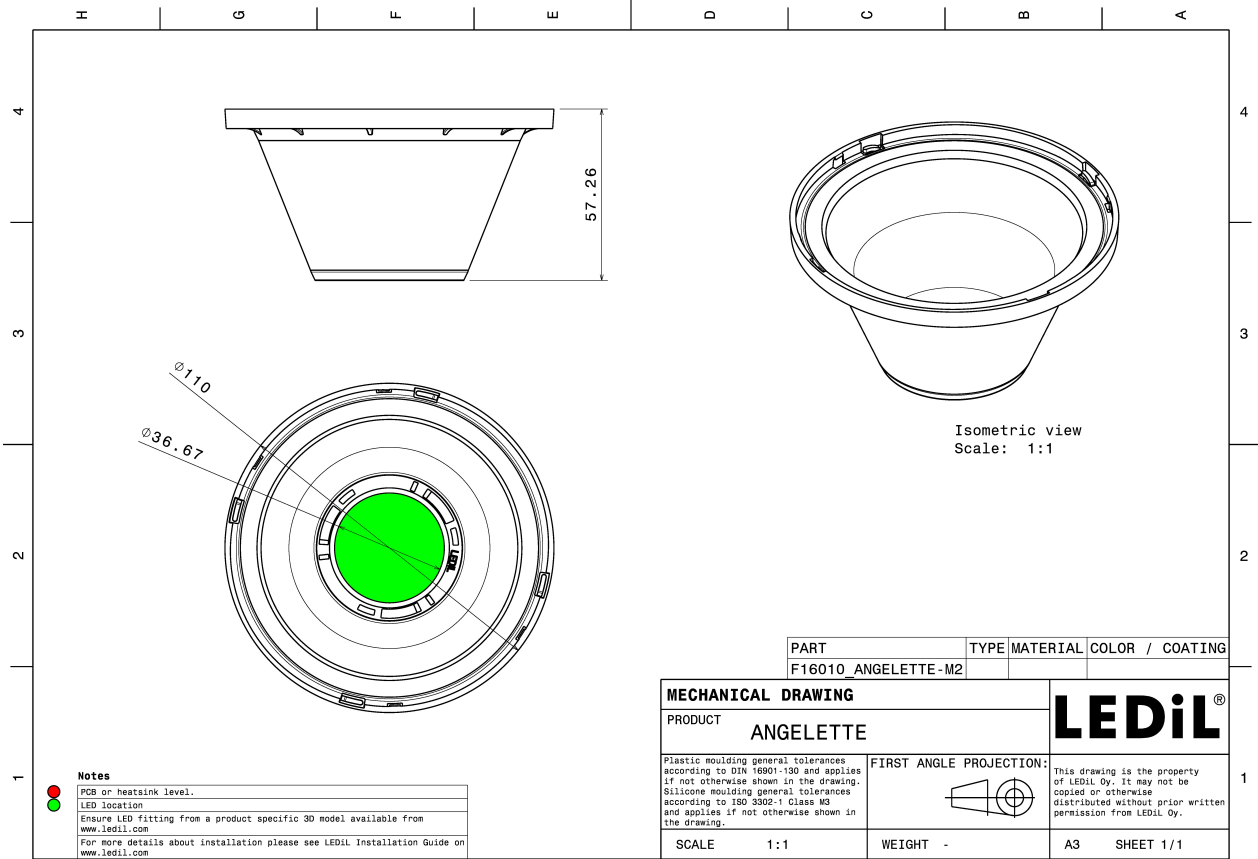



ORDERING INFORMATION:

Component	Qty in box	MOQ	MPQ	Box weight (kg)
F16010_ANGELETTE-M2 » Box size: 398 x 298 x 265 mm	120	90	30	5.2

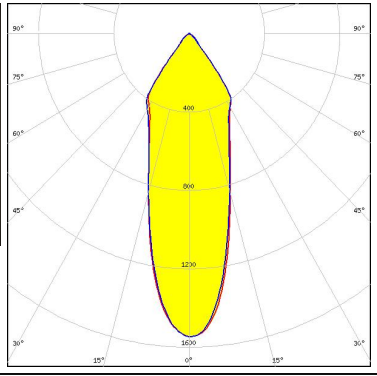

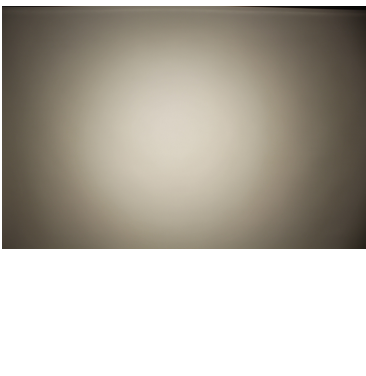
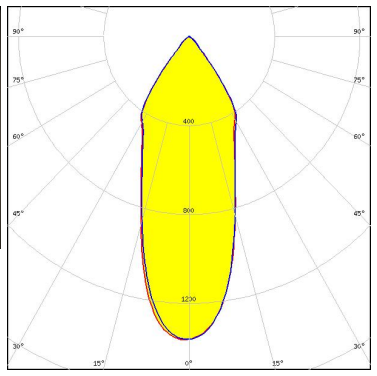

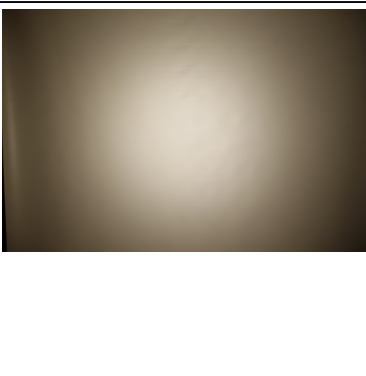
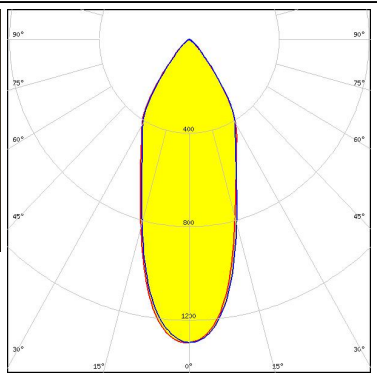

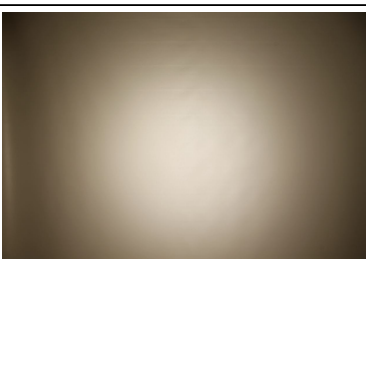
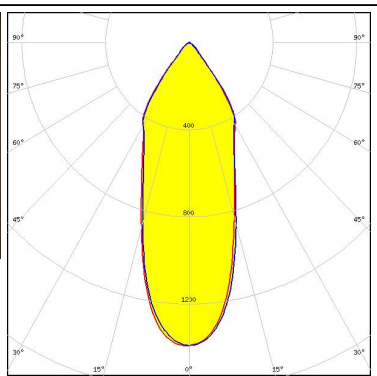



See also our general installation guide: www.ledil.com/installation_guide

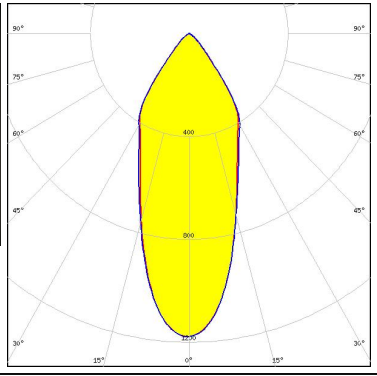

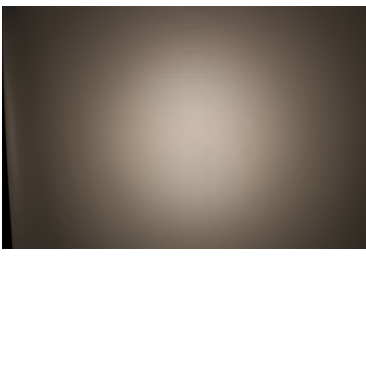
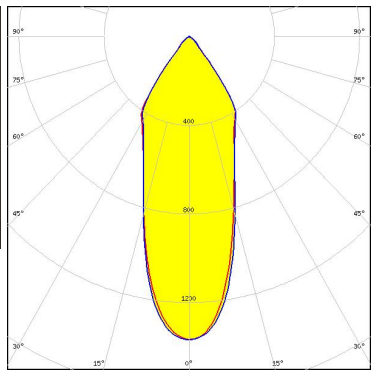

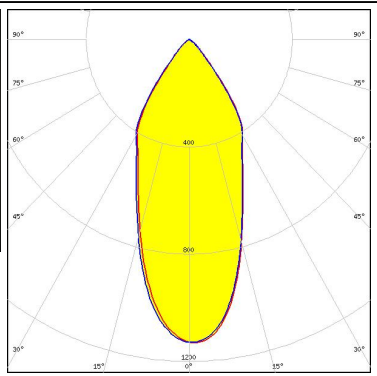

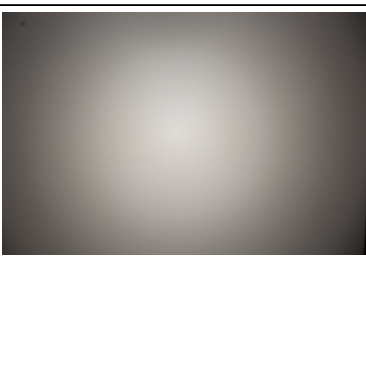
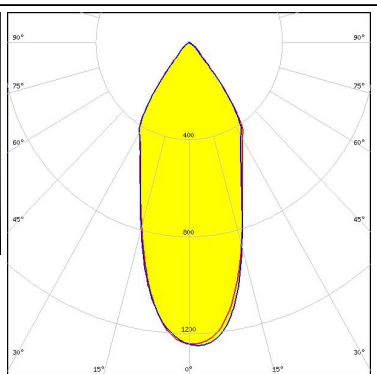
PHOTOMETRIC DATA (MEASURED):

<p></p> <p>LED Vero SE 13</p> <p>FWHM / FWTM 33.0° / 79.0°</p> <p>Efficiency 87 %</p> <p>Peak intensity 1.5 cd/lm</p> <p>LEDs/each optic 1</p> <p>Light colour White</p> <p>Required components: C16402_CLAMP-VEROSE-13-18</p>		
<p></p> <p>LED Vero SE 18</p> <p>FWHM / FWTM 38.0° / 81.0°</p> <p>Efficiency 86 %</p> <p>Peak intensity 1.4 cd/lm</p> <p>LEDs/each optic 1</p> <p>Light colour White</p> <p>Required components: C16402_CLAMP-VEROSE-13-18</p>		
<p></p> <p>LED VERO18</p> <p>FWHM / FWTM 38.0° / 82.0°</p> <p>Efficiency 84 %</p> <p>Peak intensity 1.3 cd/lm</p> <p>LEDs/each optic 1</p> <p>Light colour White</p> <p>Required components: C13658_CLAMP-VERO13-18 F15412_ANGELETTE-DL</p>		
<p></p> <p>LED VERO18</p> <p>FWHM / FWTM 37.0° / 80.0°</p> <p>Efficiency 87 %</p> <p>Peak intensity 1.4 cd/lm</p> <p>LEDs/each optic 1</p> <p>Light colour White</p> <p>Required components: C13658_CLAMP-VERO13-18</p>		

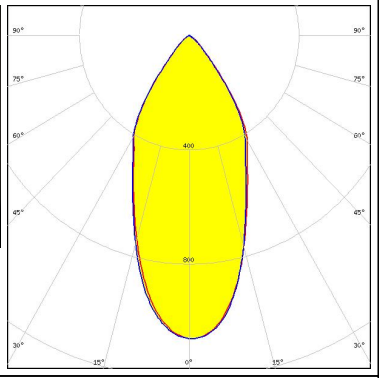

PHOTOMETRIC DATA (MEASURED):

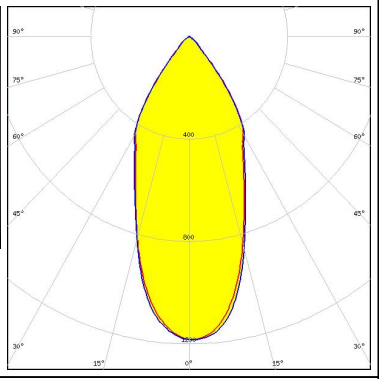
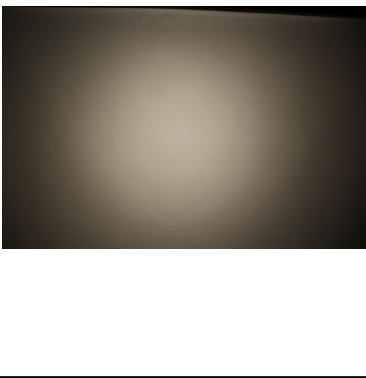
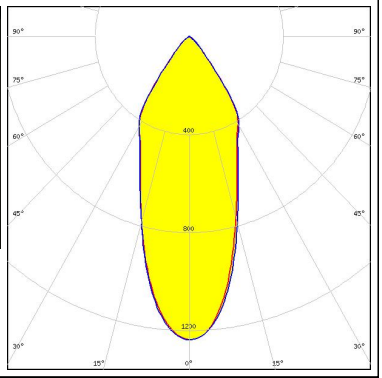
<p></p> <p>LED Vesta TW 15mm DP FWHM / FWTM 39.0° / 83.0° Efficiency 79 % Peak intensity 1.2 cd/m LEDs/each optic 1 Light colour White</p> <p>Required components: C13658_CLAMP-VERO13-18 F13671_ANGE-RZ-LENS Bender Wirth: 482 Typ L2</p>		
<p></p> <p>LED Vesta TW 15mm DP FWHM / FWTM 37.0° / 80.0° Efficiency 85 % Peak intensity 1.4 cd/m LEDs/each optic 1 Light colour White</p> <p>Required components: C13658_CLAMP-VERO13-18 Bender Wirth: 482 Typ L2</p>		
<p></p> <p>LED Vesta TW 18mm (31W) DP FWHM / FWTM 43.0° / 84.0° Efficiency 80 % Peak intensity 1.1 cd/m LEDs/each optic 1 Light colour Tunable White</p> <p>Required components: C13584_CLAMP-VERO29 F13671_ANGE-RZ-LENS Bender Wirth: 483 Typ L3</p>		
<p></p> <p>LED Vesta TW 18mm (31W) DP FWHM / FWTM 41.0° / 82.0° Efficiency 85 % Peak intensity 1.3 cd/m LEDs/each optic 1 Light colour Tunable White</p> <p>Required components: C13584_CLAMP-VERO29 Bender Wirth: 483 Typ L3</p>		

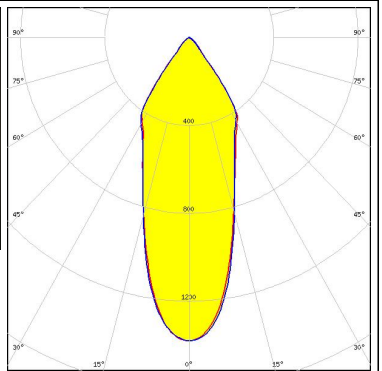
PHOTOMETRIC DATA (MEASURED):

<p></p> <p>LED Vesta TW 22mm DP FWHM / FWTM 46.0° / 85.0° Efficiency 79 % Peak intensity 1.1 cd/lm LEDs/each optic 1 Light colour Tunable White</p> <p>Required components: C13584_CLAMP-VERO29 F13671_ANGE-RZ-LENS Bender Wirth: 494 Typ L3</p>		
<p></p> <p>LED Vesta TW 22mm DP FWHM / FWTM 44.0° / 83.0° Efficiency 85 % Peak intensity 1.2 cd/lm LEDs/each optic 1 Light colour Tunable White</p> <p>Required components: C13584_CLAMP-VERO29 Bender Wirth: 494 Typ L3</p>		
<h3>CITIZEN</h3> <p>LED CLL03x/CLU03x FWHM / FWTM 39.0° / 81.0° Efficiency 82 % Peak intensity 1.2 cd/lm LEDs/each optic 1 Light colour White</p> <p>Required components: C16791_CLAMP-Z45-A F13671_ANGE-RZ-LENS TE Connectivity: 2325807-3</p>		
<h3>CITIZEN</h3> <p>LED CLL03x/CLU03x FWHM / FWTM 37.0° / 79.0° Efficiency 86 % Peak intensity 1.4 cd/lm LEDs/each optic 1 Light colour White</p> <p>Required components: C16791_CLAMP-Z45-A TE Connectivity: 2325807-3</p>		

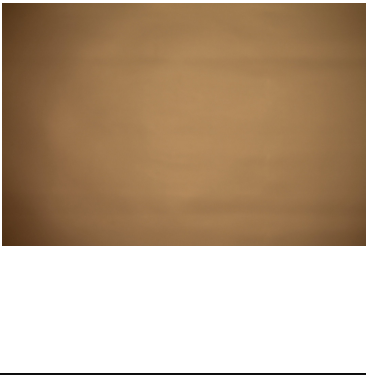
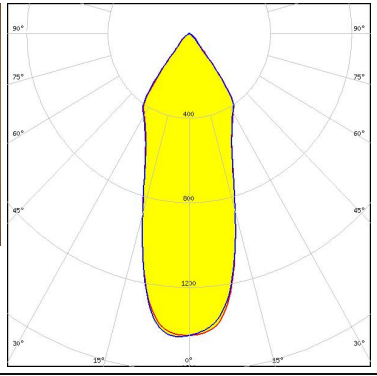
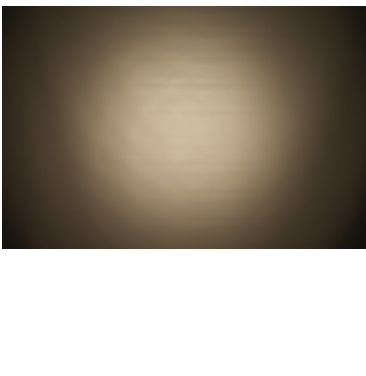
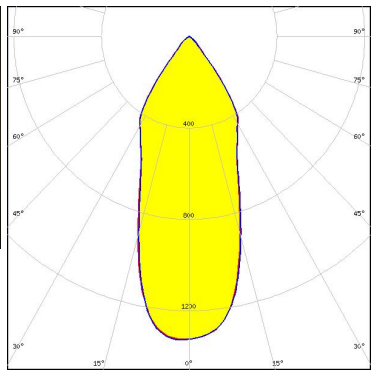
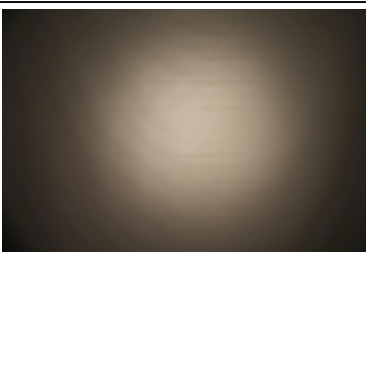
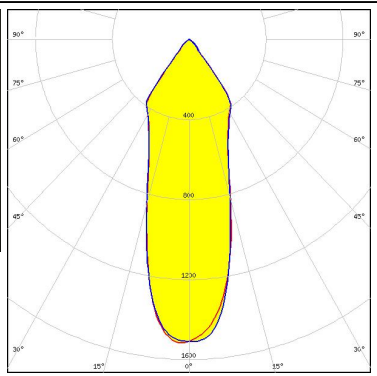
PHOTOMETRIC DATA (MEASURED):

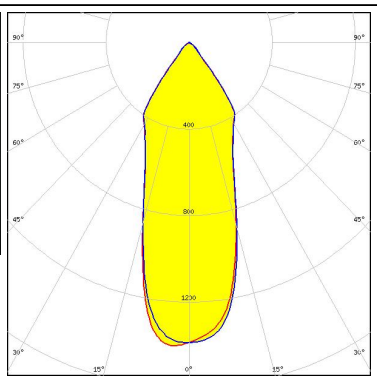
<p>CREE ⇄ LED</p> <p>LED CMA1840 FWHM / FWTM 36.0° / 80.0° Efficiency 88 % Peak intensity 1.4 cd/lm LEDs/each optic 1 Light colour White Required components: C14123_CLAMP-CXA15-18</p>		
<p>CREE ⇄ LED</p> <p>LED CMA2550 FWHM / FWTM 39.0° / 81.0° Efficiency 88 % Peak intensity 1.3 cd/lm LEDs/each optic 1 Light colour White Required components: C14036_CLAMP_CXA25-30</p>		
<p>CREE ⇄ LED</p> <p>LED CMT14xx FWHM / FWTM 33.0° / 79.0° Efficiency 87 % Peak intensity 1.5 cd/lm LEDs/each optic 1 Light colour White Required components: C13658_CLAMP-VERO13-18 Bender Wirth: 434 Typ L1</p>		
<p>CREE ⇄ LED</p> <p>LED CMT19xx FWHM / FWTM 36.0° / 80.0° Efficiency 87 % Peak intensity 1.4 cd/lm LEDs/each optic 1 Light colour White Required components: C13658_CLAMP-VERO13-18 Bender Wirth: 477 Typ L1</p>		

PHOTOMETRIC DATA (MEASURED):

CREE LED

LED CMT28xx
 FWHM / FWTM 43.0° / 83.0°
 Efficiency 87 %
 Peak intensity 1.2 cd/lm
 LEDs/each optic 1
 Light colour White
 Required components:
 C13584_CLAMP-VERO29
 Bender Wirth: 471 Typ L3

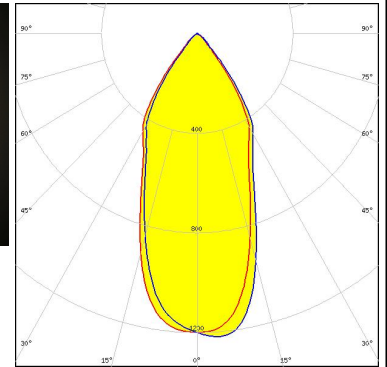
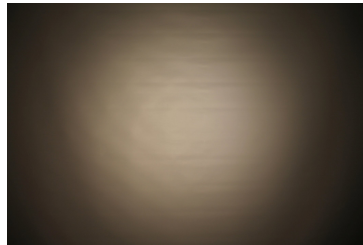

CREE LED

LED CXA/B 1816 & CXA/B 1820 & CXA 1850
 FWHM / FWTM 31.0° / 79.0°
 Efficiency 88 %
 Peak intensity 1.6 cd/lm
 LEDs/each optic 1
 Light colour White
 Required components:
 C14123_CLAMP-CXA15-18

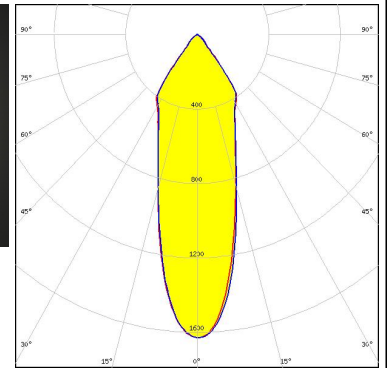
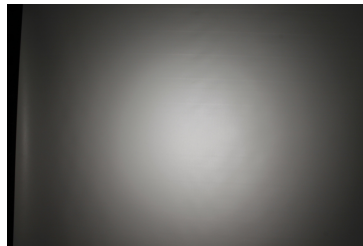

LUMILEDS

LED LUXEON CoB 1204/1205
 FWHM / FWTM 33.0° / 78.0°
 Efficiency 86 %
 Peak intensity 1.6 cd/lm
 LEDs/each optic 1
 Light colour White
 Required components:
 TE Connectivity: 2213130-2 + OPTIC CLIP Z50 TYPE1 2213194-1

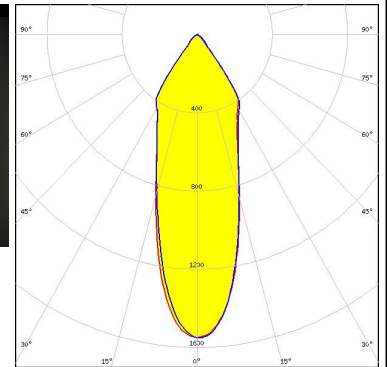



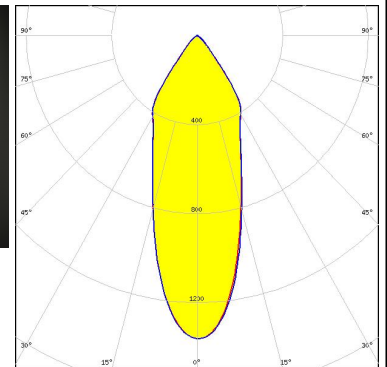
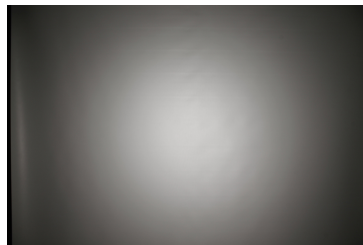

LUMILEDS

LED LUXEON CoB 1204/1205
 FWHM / FWTM 35.0° / 80.0°
 Efficiency 82 %
 Peak intensity 1.4 cd/lm
 LEDs/each optic 1
 Light colour White
 Required components:
 F13671_ANGE-RZ-LENS
 TE Connectivity: 2213130-2 + OPTIC CLIP Z50 TYPE1 2213194-1

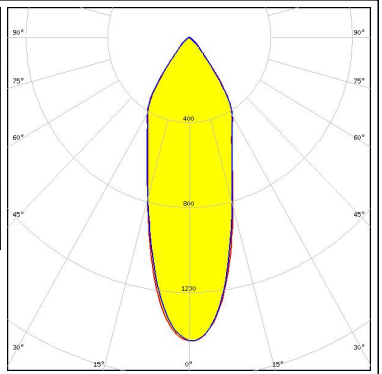

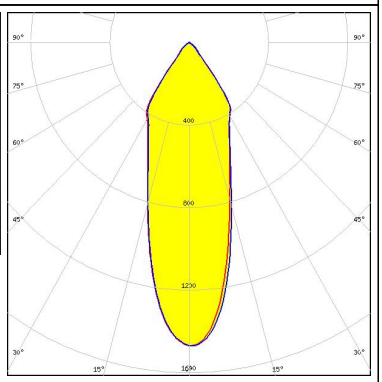
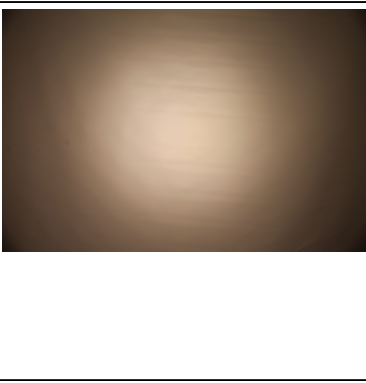
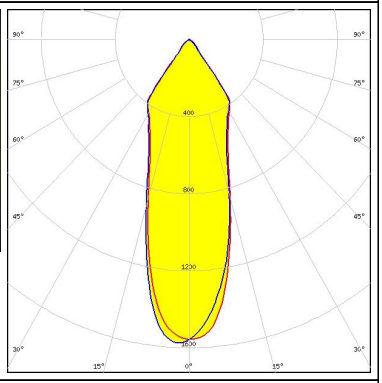

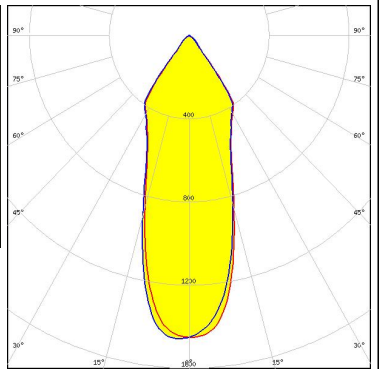

PHOTOMETRIC DATA (MEASURED):

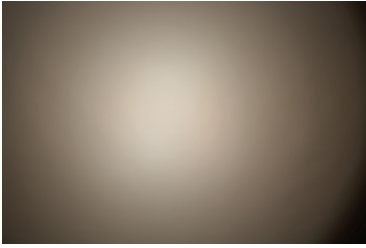
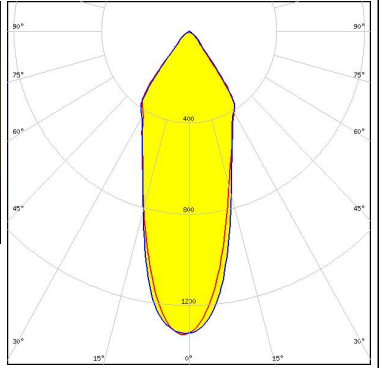
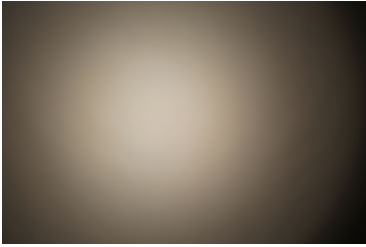
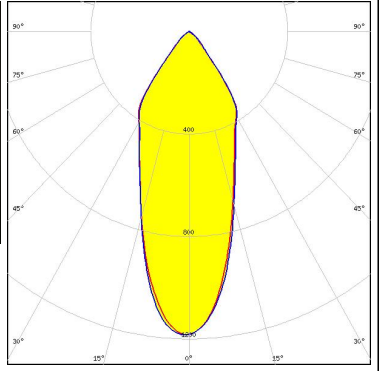
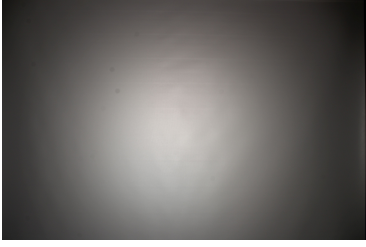
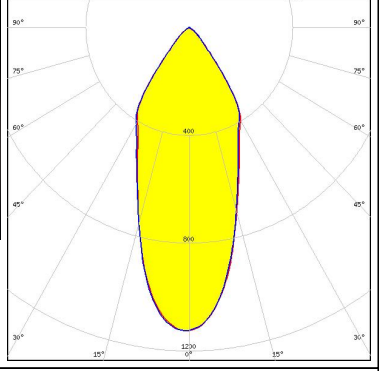
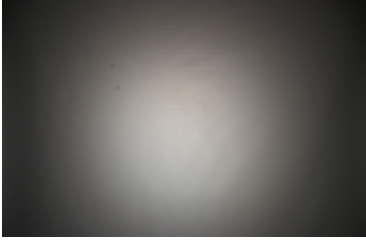
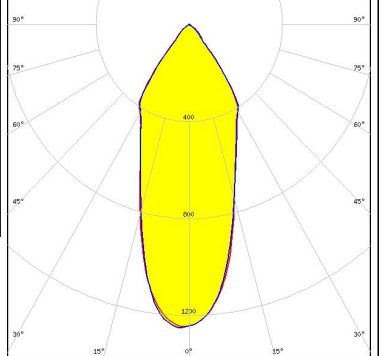
<p>LUMILEDS</p> <p>LED LUXEON CoB 1204/1205</p> <p>FWHM / FWTM 34.0° / 80.0°</p> <p>Efficiency 83 %</p> <p>Peak intensity 1.4 cd/m</p> <p>LEDs/each optic 1</p> <p>Light colour White</p> <p>Required components: F15412_ANGELETTE-DL TE Connectivity: 2213130-2 + OPTIC CLIP Z50 TYPE1 2213194-1</p>		
<p>LUMILEDS</p> <p>LED LUXEON CoB 1204/1205</p> <p>FWHM / FWTM 33.0° / 78.0°</p> <p>Efficiency 83 %</p> <p>Peak intensity 1.5 cd/m</p> <p>LEDs/each optic 1</p> <p>Light colour White</p> <p>Required components: F15176_ANGELETTE-LENS TE Connectivity: 2213130-2 + OPTIC CLIP Z50 TYPE1 2213194-1</p>		
<p>LUMILEDS</p> <p>LED LUXEON CoB 1204HD</p> <p>FWHM / FWTM 33.0° / 77.0°</p> <p>Efficiency 87 %</p> <p>Peak intensity 1.6 cd/m</p> <p>LEDs/each optic 1</p> <p>Light colour White</p> <p>Required components: TE Connectivity: 2213382-2 + OPTIC CLIP Z50 TYPE1 2213194-1</p>		
<p>LUMILEDS</p> <p>LED LUXEON CoB 1205HD</p> <p>FWHM / FWTM 35.0° / 78.0°</p> <p>Efficiency 87 %</p> <p>Peak intensity 1.5 cd/m</p> <p>LEDs/each optic 1</p> <p>Light colour White</p> <p>Required components: F15858_HEKLA-SOCKET-H</p>		

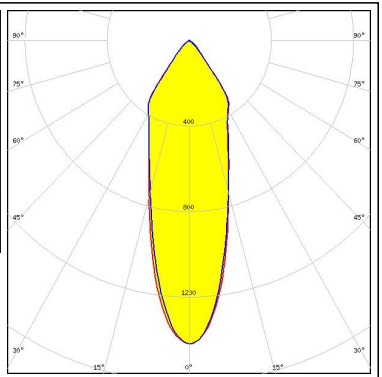
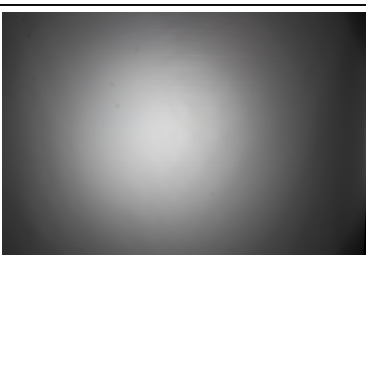
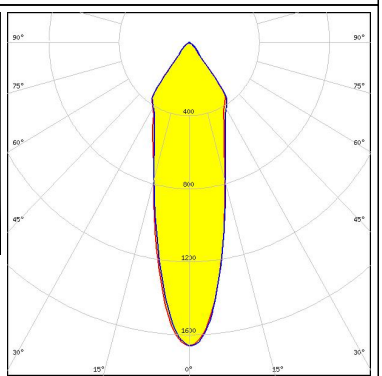

PHOTOMETRIC DATA (MEASURED):

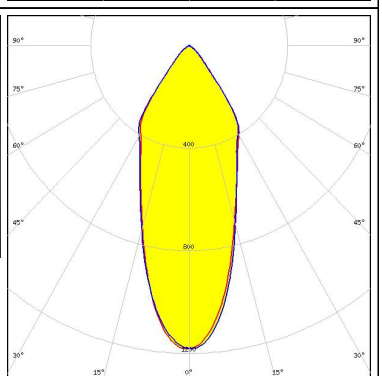
<p>LUMINUS</p> <p>LED CDM-14 (Dim-To-Warm)</p> <p>FWHM / FWTM 35.0° / 80.0°</p> <p>Efficiency 83 %</p> <p>Peak intensity 1.3 cd/m</p> <p>LEDs/each optic 1</p> <p>Light colour White</p> <p>Required components: C13658_CLAMP-VERO13-18 Bender Wirth: 491 Typ L2</p>		
<p>LUMINUS</p> <p>LED CDM-14 (Dim-To-Warm)</p> <p>FWHM / FWTM 38.0° / 82.0°</p> <p>Efficiency 78 %</p> <p>Peak intensity 1.2 cd/m</p> <p>LEDs/each optic 1</p> <p>Light colour White</p> <p>Required components: C13658_CLAMP-VERO13-18 F13671_ANGE-RZ-LENS Bender Wirth: 491 Typ L2</p>		
<p>LUMINUS</p> <p>LED CDM-18 (Dim-To-Warm)</p> <p>FWHM / FWTM 41.0° / 83.0°</p> <p>Efficiency 78 %</p> <p>Peak intensity 1.1 cd/m</p> <p>LEDs/each optic 1</p> <p>Light colour White</p> <p>Required components: C13658_CLAMP-VERO13-18 F13671_ANGE-RZ-LENS Bender Wirth: 491 Typ L2</p>		
<p>LUMINUS</p> <p>LED CDM-18 (Dim-To-Warm)</p> <p>FWHM / FWTM 38.0° / 81.0°</p> <p>Efficiency 83 %</p> <p>Peak intensity 1.3 cd/m</p> <p>LEDs/each optic 1</p> <p>Light colour White</p> <p>Required components: C13658_CLAMP-VERO13-18 Bender Wirth: 491 Typ L2</p>		

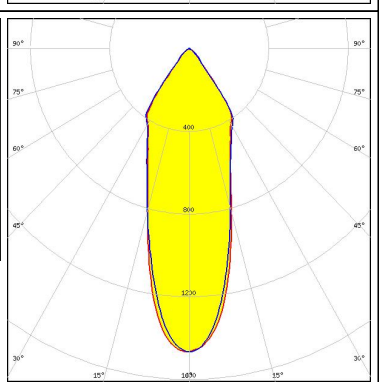

PHOTOMETRIC DATA (MEASURED):

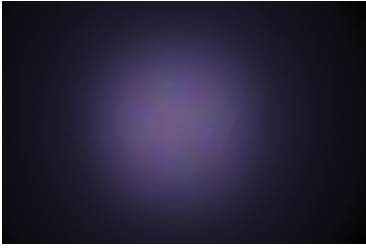
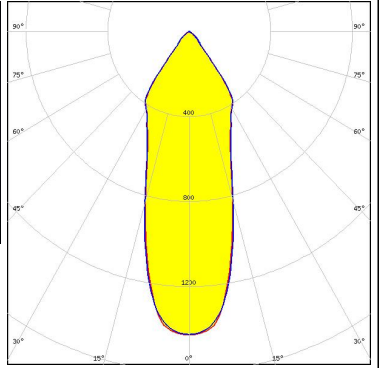
<p>LUMINUS</p> <p>LED CDM-9 (Dim-To-Warm)</p> <p>FWHM / FWTM 32.0° / 79.0°</p> <p>Efficiency 80 %</p> <p>Peak intensity 1.4 cd/lm</p> <p>LEDs/each optic 1</p> <p>Light colour White</p> <p>Required components:</p> <p>C13658_CLAMP-VERO13-18</p> <p>F13671_ANGE-RZ-LENS</p> <p>Bender Wirth: 490 Typ L1</p>		
<p>LUMINUS</p> <p>LED CDM-9 (Dim-To-Warm)</p> <p>FWHM / FWTM 28.0° / 77.0°</p> <p>Efficiency 84 %</p> <p>Peak intensity 1.7 cd/lm</p> <p>LEDs/each optic 1</p> <p>Light colour White</p> <p>Required components:</p> <p>C13658_CLAMP-VERO13-18</p> <p>Bender Wirth: 490 Typ L1</p>		
<p>LUMINUS</p> <p>LED CTM-14 (Tunable White)</p> <p>FWHM / FWTM 39.0° / 82.0°</p> <p>Efficiency 79 %</p> <p>Peak intensity 1.2 cd/lm</p> <p>LEDs/each optic 1</p> <p>Light colour White</p> <p>Required components:</p> <p>C13584_CLAMP-VERO29</p> <p>F13671_ANGE-RZ-LENS</p> <p>Bender Wirth: 442 Typ L3</p>		
<p>LUMINUS</p> <p>LED CTM-14 (Tunable White)</p> <p>FWHM / FWTM 33.0° / 79.0°</p> <p>Efficiency 85 %</p> <p>Peak intensity 1.5 cd/lm</p> <p>LEDs/each optic 1</p> <p>Light colour White</p> <p>Required components:</p> <p>C13584_CLAMP-VERO29</p> <p>Bender Wirth: 442 Typ L3</p>		

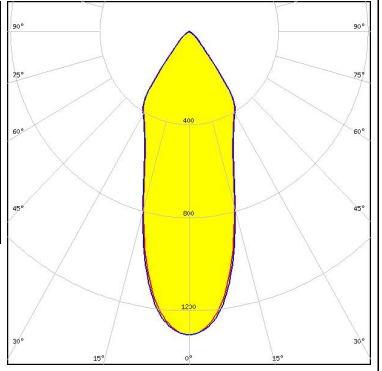
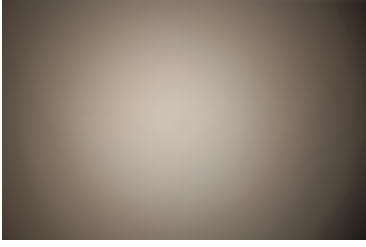
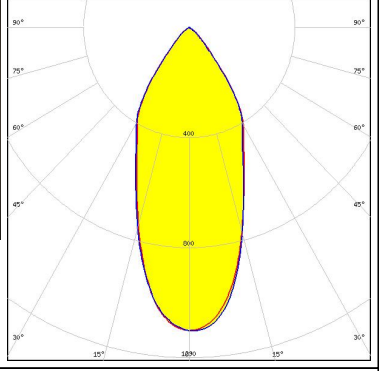
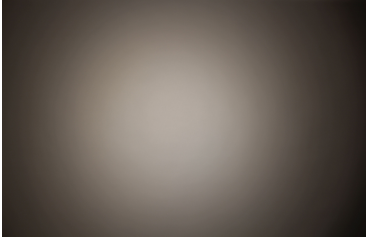
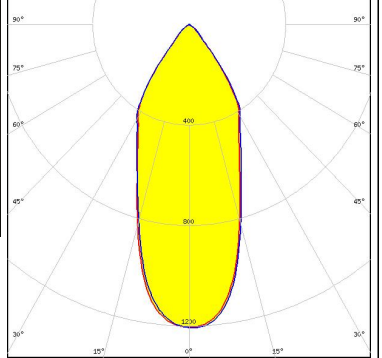
PHOTOMETRIC DATA (MEASURED):

<p>LUMINUS</p> <p>LED CTM-14 RGBW FWHM / FWTM 34.0° / 78.0° Efficiency 86 % Peak intensity 1.5 cd/m LEDs/each optic 1 Light colour RGBW</p> <p>Required components: C13584_CLAMP-VERO29 F13671_ANGE-RZ-LENS Bender Wirth: 500 Typ L3-1</p>		
<p>LUMINUS</p> <p>LED CTM-14 RGBW FWHM / FWTM 36.0° / 80.0° Efficiency 82 % Peak intensity 1.3 cd/m LEDs/each optic 1 Light colour RGBW</p> <p>Required components: C13584_CLAMP-VERO29 F13671_ANGE-RZ-LENS Bender Wirth: 500 Typ L3-1</p>		
<p>LUMINUS</p> <p>LED CTM-22 (Tunable White) FWHM / FWTM 43.0° / 84.0° Efficiency 79 % Peak intensity 1.1 cd/m LEDs/each optic 1 Light colour White</p> <p>Required components: C13584_CLAMP-VERO29 F13671_ANGE-RZ-LENS Bender Wirth: 494 Typ L3</p>		
<p>LUMINUS</p> <p>LED CTM-22 (Tunable White) FWHM / FWTM 42.0° / 83.0° Efficiency 84 % Peak intensity 1.2 cd/m LEDs/each optic 1 Light colour White</p> <p>Required components: C13584_CLAMP-VERO29 Bender Wirth: 494 Typ L3</p>		

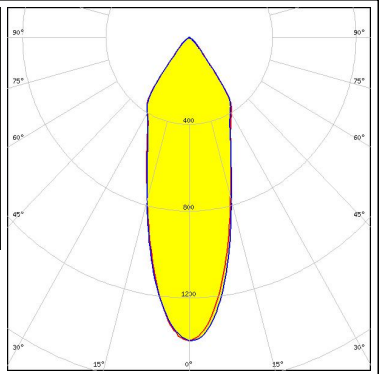
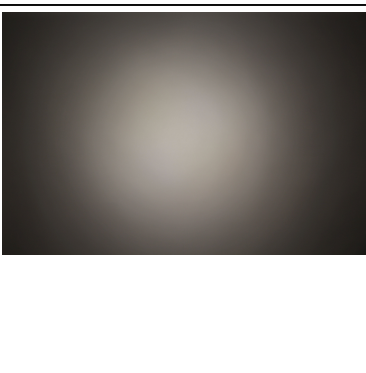
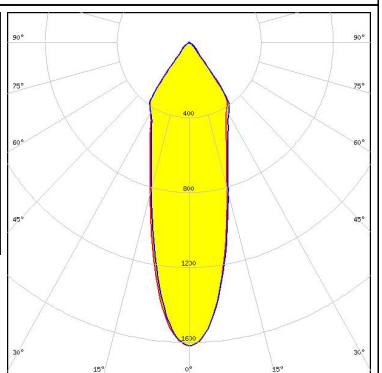
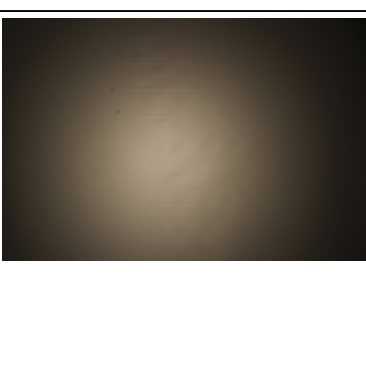
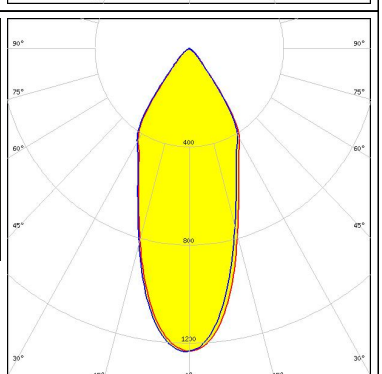
PHOTOMETRIC DATA (MEASURED):

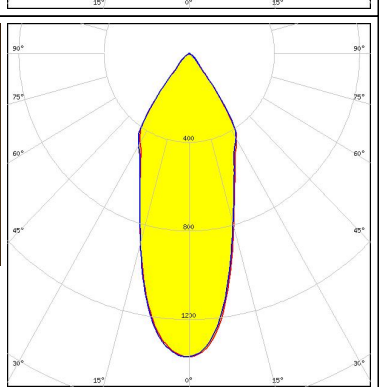
<p>NICHIA</p> <p>LED NVCWJ024Z-V1MT: COB J-Type Tunable White</p> <p>FWHM / FWTM 34.0° / 80.0°</p> <p>Efficiency 81 %</p> <p>Peak intensity 1.4 cd/m</p> <p>LEDs/each optic 1</p> <p>Light colour White</p> <p>Required components: C13658_CLAMP-VERO13-18 F13671_ANGE-RZ-LENS Bender Wirth: 498 Typ L2</p>		
<p>NICHIA</p> <p>LED NVCWJ024Z-V1MT: COB J-Type Tunable White</p> <p>FWHM / FWTM 31.0° / 78.0°</p> <p>Efficiency 86 %</p> <p>Peak intensity 1.6 cd/m</p> <p>LEDs/each optic 1</p> <p>Light colour White</p> <p>Required components: C13658_CLAMP-VERO13-18 Bender Wirth: 498 Typ L2</p>		
<p>OSRAM</p> <p>LED PrevaLED Core G7 L15 H1</p> <p>FWHM / FWTM 40.0° / 81.0°</p> <p>Efficiency 82 %</p> <p>Peak intensity 1.2 cd/m</p> <p>LEDs/each optic 1</p> <p>Light colour White</p> <p>Required components: C16685_CLAMP-PRV-A F13671_ANGE-RZ-LENS</p>		
<p>OSRAM</p> <p>LED PrevaLED Core G7 L15 H1</p> <p>FWHM / FWTM 38.0° / 79.0°</p> <p>Efficiency 86 %</p> <p>Peak intensity 1.4 cd/m</p> <p>LEDs/each optic 1</p> <p>Light colour White</p> <p>Required components: C16685_CLAMP-PRV-A</p>		

PHOTOMETRIC DATA (MEASURED):

PHILIPS

LED Fortimo SLM L13 CoB
 FWHM / FWTM 38.0° / 81.0°
 Efficiency 81 %
 Peak intensity 1.3 cd/lm
 LEDs/each optic 1
 Light colour White

Required components:

F13671_ANGE-RZ-LENS

TE Connectivity: 2213130-2 + OPTIC CLIP Z50 TYPE1 2213194-1

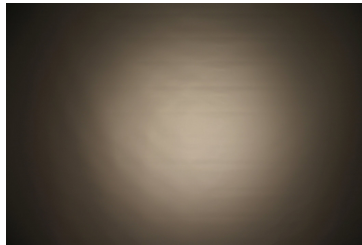

PHILIPS

LED Fortimo SLM L13 CoB
 FWHM / FWTM 36.0° / 79.0°
 Efficiency 87 %
 Peak intensity 1.4 cd/lm
 LEDs/each optic 1
 Light colour White

Required components:

TE Connectivity: 2213130-2 + OPTIC CLIP Z50 TYPE1 2213194-1

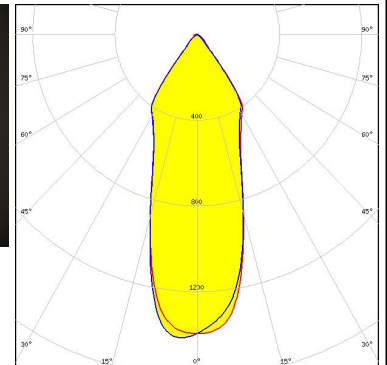
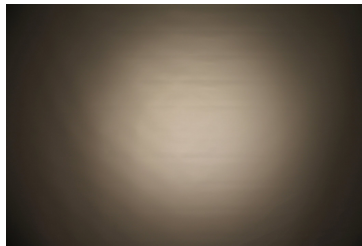

PHILIPS

LED Fortimo SLM L15 CoB
 FWHM / FWTM 38.0° / 80.0°
 Efficiency 87 %
 Peak intensity 1.3 cd/lm
 LEDs/each optic 1
 Light colour White

Required components:

TE Connectivity: 2213130-2 + OPTIC CLIP Z50 TYPE1 2213194-1

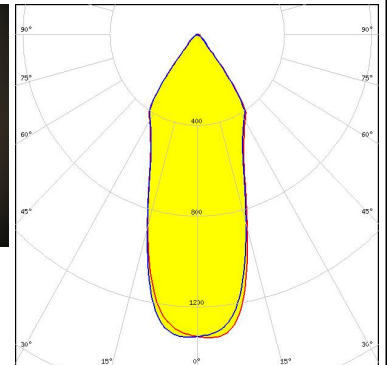
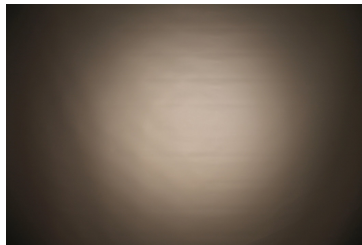

PHILIPS

LED Fortimo SLM L15 CoB
 FWHM / FWTM 39.0° / 82.0°
 Efficiency 82 %
 Peak intensity 1.2 cd/lm
 LEDs/each optic 1
 Light colour White

Required components:

F13671_ANGE-RZ-LENS

TE Connectivity: 2213130-2 + OPTIC CLIP Z50 TYPE1 2213194-1

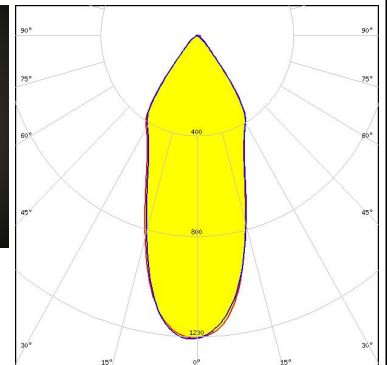
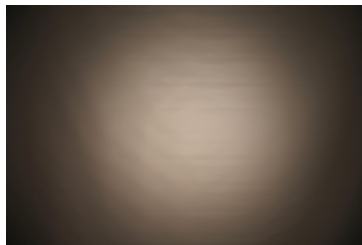

PHOTOMETRIC DATA (MEASURED):

SAMSUNG

LED LC035T (Tunable white)
 FWHM / FWTM 47.0° / 86.0°
 Efficiency 79 %
 Peak intensity 1 cd/lm
 LEDs/each optic 1
 Light colour Tunable White
 Required components:
 C13584_CLAMP-VERO29
 F13671_ANGE-RZ-LENS
 Bender Wirth: 502 Typ L3

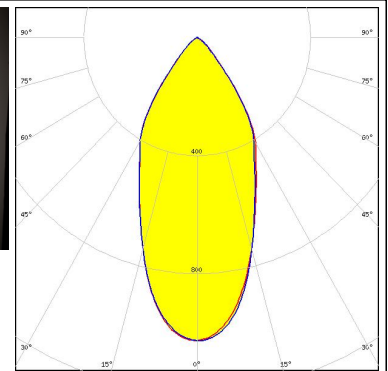
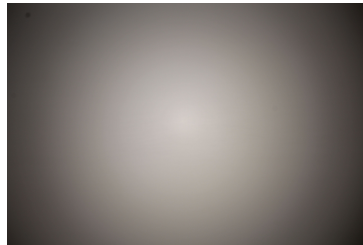

SAMSUNG

LED LC035T (Tunable white)
 FWHM / FWTM 44.0° / 83.0°
 Efficiency 85 %
 Peak intensity 1.2 cd/lm
 LEDs/each optic 1
 Light colour Tunable White
 Required components:
 C13584_CLAMP-VERO29
 Bender Wirth: 502 Typ L3

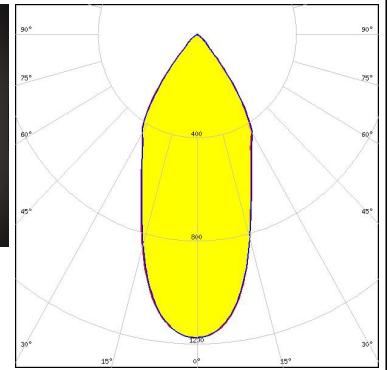
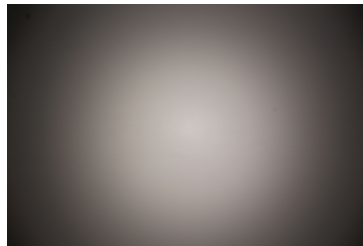

XICATO

LED XTM - 19mm LES
 FWHM / FWTM 37.0° / 80.0°
 Efficiency 88 %
 Peak intensity 1.4 cd/lm
 LEDs/each optic 1
 Light colour White
 Required components:
 C16491_XTM-ADAPTER-50-A

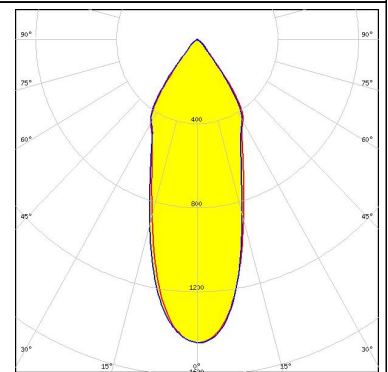

GENERAL INFORMATION:

NOTE: The typical beam angle will be changed by different color, chip size and chip position tolerance. The typical total beam angle is the full angle measured where the luminous intensity is half of the peak value.

Due to use of high power COB's with this product, special attention to proper thermal design is highly recommended. LEDiL has no liability for direct, indirect or consecutive damages arising from the LEDiL products being used outside of the recommended temperature range.

MATERIALS:

As part of our continuous research and improvement processes, and to ensure the best possible quality and availability of our products, LEDiL reserves the right to change material grades without notice.

PRODUCT DATA USER AGREEMENT AND DISCLAIMER:

The measured data in the provided downloadable LEDiL Product Datasheets and Mechanical 2D-Drawings is rounded and provided as reference for planning. LEDiL Oy's optical specifications have been verified by conducting performance testing of the products in accordance with the company's quality system. The reported data are averaged results of multiple measurements with typical variation. LEDiL Oy reserves the right to without prior notification make changes and improvements to its products.

LEDiL Oy assumes neither warranty, nor guarantee nor any other liability of any kind for the contents and correctness of the provided data. The provided data has been generated with highest diligence but the provided data may in reality not represent the complete possible variation range of all intrinsic parameters. Therefore, in certain cases a deviation from the provided data could occur.

LEDiL Oy reserves the right to undertake technical changes of its products without further notification which could lead to changes in the provided data. LEDiL Oy assumes no liability of any kind for the possible deviation from any provided data or any other damage resulting from the usage of the provided data.

The user agrees to this disclaimer and user agreement with the download or usage of the provided files.

LEDiL Oy

Joensuunkatu 13
FI-24240 SALO
Finland

LEDiL Inc.

228 West Page Street
Suite D
Sycamore IL 60178
USA

Ledil Optics Technology (Shenzhen) Co., Ltd.

405 , Block B
Casic Motor Building
Shenzhen 518057
P.R.CHINA

Local sales and technical support

[www.ledil.com/
where_to_buy](http://www.ledil.com/where_to_buy)

Shipping locations

Salo, Finland
Hong Kong, China

Distribution Partners

[www.ledil.com/
where_to_buy](http://www.ledil.com/where_to_buy)