

For the electronic measurement of current: DC, AC, pulsed..., with galvanic separation between the primary and the secondary circuit.



Features

- Open loop multi-range current transducer
- Voltage output
- Single power supply +5 V
- Overcurrent detect $2.93 \times I_{PN}$ (peak value)
- Galvanic separation between primary and secondary circuit
- Low power consumption
- Compact design for panel mounting
- Aperture: 15 × 8 mm
- Factory calibrated
- Connection mating with JST:
 - housing PHR-5
 - contact SPH-00xT
- Repositionable mounting foot
- **Dedicated parameter settings available on request (see page 12).**

Advantages

- Low offset drift
- Over-drivable V_{ref}
- 8 mm creepage /clearance
- Fast response
- Low profile 2 mm pitch connector for 24 to 32 AWG wire.

Applications

- AC variable speed and servo motor drives
- Static converters for DC motor drives
- Battery supplied applications
- Uninterruptible Power Supplies (UPS)
- Switched Mode Power Supplies (SMPS)
- Power supplies for welding applications
- Combiner box
- MPPT.

Standards

- IEC 61800-1: 1997
- IEC 61800-2: 2015
- IEC 61800-3: 2004
- IEC 61800-5-1: 2007
- IEC 62109-1: 2010
- UL 508: 2013.

Application Domain

- Industrial.

Absolute maximum ratings

Parameter	Symbol	Unit	Value
Supply voltage (not destructive)	U_C	V	8
Supply voltage (not entering non standard modes)	U_C	V	6.5
Primary conductor temperature	T_B	°C	120
Electrostatic discharge voltage	U_{ESD}	kV	2

Stresses above these ratings may cause permanent damage. Exposure to absolute maximum ratings for extended periods may degrade reliability.

UL 508: Ratings and assumptions of certification

File # E189713 Volume: 2 Section: 5

Standards

- CSA C22.2 NO. 14-10 INDUSTRIAL CONTROL EQUIPMENT - Edition 12
- UL 508 STANDARD FOR INDUSTRIAL CONTROL EQUIPMENT - Edition 17

Ratings

Parameter	Symbol	Unit	Value
Primary involved potential		V AC/DC	600
Max surrounding air temperature	T_A	°C	105
Primary current	I_P	A	According to series primary current
Secondary supply voltage	U_C	V DC	5
Output voltage	V_{out}	V	0 to 5

Conditions of acceptability

- 1 - These devices have been evaluated for overvoltage category III and for use in pollution degree 2 environment.
- 2 - A suitable enclosure shall be provided in the end-use application.
- 3 - The terminals have not been evaluated for field wiring.
- 5 - Primary terminals shall not be straightened since assembly of housing case depends upon bending of the terminals.
- 6 - Any surface of polymeric housing have not been evaluated as insulating barrier.
- 7 - Low voltage control circuit shall be supplied by an isolating source (such as a transformer, optical isolator, limiting impedance or electro-mechanical relay).

Marking

Only those products bearing the UR Mark should be considered to be Listed or Recognized and covered under UL's Follow-Up Service. Always look for the Mark on the product.

Insulation coordination

Parameter	Symbol	Unit	Value	Comment
RMS voltage for AC insulation test 50/60 Hz/1 min	U_d	kV	4.3	
Impulse withstand voltage 1.2/50 μ s	\hat{U}_w	kV	8	
Partial discharge test voltage (adjusted $q_m < 10$ pC)	U_t	V	1500	Busbar / Secondary, jumpers/ secondary
Clearance (pri. - sec.)	d_{Cl}	mm	> 8	Shortest distance through air
Creepage distance (pri. - sec.)	d_{cp}	mm	> 8	Shortest path along device body
Clearance (pri. - sec.)	-	mm	> 8	When mounted on PCB with recommended layout
Case material	-	-	V0 according to UL 94	
Comparative tracking index	CTI		600	
Application example	-	-	600 V CAT III PD2	Reinforced insulation according to IEC 61800-5-1
Application example	-	-	1000 V CAT III PD2	Basic insulation according to IEC 61800-5-1

Environmental and mechanical characteristics

Parameter	Symbol	Unit	Min	Typ	Max	Comment
Ambient operating temperature	T_A	$^{\circ}$ C	-40		105	
Ambient storage temperature	T_S	$^{\circ}$ C	-40		105	
Mass	m	g		32		

Electrical data HO 50-S-0100

 At $T_A = 25\text{ °C}$, $U_C = +5\text{ V}$, $R_L = 10\text{ k}\Omega$ unless otherwise noted (see Min, Max, typ. definition paragraph in page 13).

Parameter	Symbol	Unit	Min	Typ	Max	Comment
Primary nominal RMS current	I_{PN}	A		50		
Primary current, measuring range	I_{PM}	A	-125		125	@ $U_C \geq 4.6\text{ V}$
Number of primary turns	N_P	-		1		See application information
Supply voltage ¹⁾	U_C	V	4.5	5	5.5	
Current consumption	I_C	mA		19	25	
Reference voltage (output)	V_{ref}	V	2.48	2.5	2.52	Internal reference
Reference voltage (input)	V_{ref}	V	0.5		2.65	External reference
Output voltage range @ I_{PM}	$V_{out} - V_{ref}$	V	-2		2	Over operating temperature range
V_{ref} output resistance	R_{ref}	Ω	130	200	300	Series
V_{out} output resistance	R_{out}	Ω		2	5	Series
Allowed capacitive load	C_L	nF	0		6	
Overcurrent detection output on resistance	R_{on}	Ω	70	95	150	Open drain, active low Over operating temperature range
Overcurrent detection hold	t_{hold}	ms	0.7	1	1.4	Additional time after threshold has released
EEPROM control	V_{out}	mV	0		50	V_{out} forced to GND when EEPROM in an error state ²⁾
Electrical offset voltage @ $I_p = 0\text{ A}$	V_{OE}	mV	-5		5	$V_{out} - V_{ref}$ @ $V_{ref} = 2.5\text{ V}$
Electrical offset current referred to primary	I_{OE}	A	-0.3125		0.3125	
Temperature coefficient of V_{ref}	TCV_{ref}	ppm/K	-170		170	-40 °C ... 105 °C
Temperature coefficient of V_{OE}	TCV_{OE}	mV/K	-0.075		0.075	-40 °C ... 105 °C
Offset drift referred to primary @ $I_p = 0\text{ A}$	TCI_{OE}	mA/K	-4.69		4.69	-40 °C ... 105 °C
Theoretical sensitivity	G_{th}	mV/A		16		800 mV @ I_{PN}
Sensitivity error @ I_{PN}	ϵ_G	%	-0.5		0.5	Factory adjustment (straight bus-bar)
Temperature coefficient of G	TCG	ppm/K	-350		350	-40 °C ... 105 °C
Linearity error 0 ... I_{PN}	ϵ_L	% of I_{PN}	-0.75		0.75	
Linearity error 0 ... I_{PM}	ϵ_L	% of I_{PM}	-0.5		0.5	
Magnetic offset current (@ $10 \times I_{PN}$) referred to primary	I_{OM}	A	-0.92		0.92	One turn
Reaction time @ 10 % of I_{PN}	t_{ra}	μs			2.5	@ 50 A/ μs
Response time @ 90 % of I_{PN}	t_r	μs			3.5	@ 50 A/ μs
Frequency bandwidth (-3 dB)	BW	kHz		100		Small signals
Output RMS noise voltage spectral density (100 Hz ... 100 kHz)	e_{no}	$\mu\text{V}/\sqrt{\text{Hz}}$			10.2	
Output noise voltage (DC ... 10 kHz) (DC ... 100 kHz) (DC ... 1 MHz)	V_{no}	mVpp		5.6 16.3 30.6		
Primary current, detection threshold	I_{PTh}	A	$2.64 \times I_{PN}$	$2.93 \times I_{PN}$	$3.22 \times I_{PN}$	Peak value $\pm 10\%$, overcurrent detection OCD
Accuracy @ I_{PN}	X	% of I_{PN}	-1.25		1.25	
Accuracy @ I_{PN} @ $T_A = +105\text{ °C}$	X	% of I_{PN}	-4.80		4.80	See formula note ³⁾
Accuracy @ I_{PN} @ $T_A = +85\text{ °C}$	X	% of I_{PN}	-3.91		3.91	See formula note ³⁾

 Notes: ¹⁾ 3.3 V SP version available

²⁾ EEPROM in an error state makes the transducer behave like a reverse current saturation. Use of the OCD may help to differentiate the two cases.

³⁾ Accuracy @ T_A (% of I_{PN}) = $X + \left(\frac{TCG}{10000} \times (T_A - 25) + \frac{TCI_{OE}}{1000 \times I_{PN}} \times 100 \times (T_A - 25) \right)$.

Electrical data HO 100-S-0100

 At $T_A = 25^\circ\text{C}$, $U_C = +5\text{V}$, $R_L = 10\text{k}\Omega$ unless otherwise noted (see Min, Max, typ. definition paragraph in page 13).

Parameter	Symbol	Unit	Min	Typ	Max	Comment
Primary nominal RMS current	I_{PN}	A		100		
Primary current, measuring range	I_{PM}	A	-250		250	@ $U_C \geq 4.6\text{V}$
Number of primary turns	N_P	-		1		See application information
Supply voltage ¹⁾	U_C	V	4.5	5	5.5	
Current consumption	I_C	mA		19	25	
Reference voltage (output)	V_{ref}	V	2.48	2.5	2.52	Internal reference
Reference voltage (input)	V_{ref}	V	0.5		2.65	External reference
Output voltage range @ I_{PM}	$V_{out} - V_{ref}$	V	-2		2	Over operating temperature range
V_{ref} output resistance	R_{ref}	Ω	130	200	300	Series
V_{out} output resistance	R_{out}	Ω		2	5	Series
Allowed capacitive load	C_L	nF	0		6	
Overcurrent detection output on resistance	R_{on}	Ω	70	95	150	Open drain, active low Over operating temperature range
Overcurrent detection hold	t_{hold}	ms	0.7	1	1.4	Additional time after threshold has released
EEPROM control	V_{out}	mV	0		50	V_{out} forced to GND when EEPROM in an error state ²⁾
Electrical offset voltage @ $I_P = 0\text{A}$	V_{OE}	mV	-5		5	$V_{out} - V_{ref}$ @ $V_{ref} = 2.5\text{V}$
Electrical offset current referred to primary	I_{OE}	A	-0.625		0.625	
Temperature coefficient of V_{ref}	TCV_{ref}	ppm/K	-170		170	-40 °C ... 105 °C
Temperature coefficient of V_{OE}	TCV_{OE}	mV/K	-0.075		0.075	-40 °C ... 105 °C
Offset drift referred to primary @ $I_P = 0\text{A}$	TCI_{OE}	mA/K	-9.375		9.375	-40 °C ... 105 °C
Theoretical sensitivity	G_{th}	mV/A		8		800 mV @ I_{PN}
Sensitivity error @ I_{PN}	ϵ_G	%	-0.5		0.5	Factory adjustment (straight bus bar)
Temperature coefficient of G	TCG	ppm/K	-350		350	-40 °C ... 105 °C
Linearity error 0 ... I_{PN}	ϵ_L	% of I_{PN}	-0.5		0.5	
Linearity error 0 ... I_{PM}	ϵ_L	% of I_{PM}	-0.5		0.5	
Magnetic offset current (@ $10 \times I_{PN}$) referred to primary	I_{OM}	A	-0.92		0.92	One turn
Reaction time @ 10 % of I_{PN}	t_{ra}	μs			2.5	@ 50 A/ μs
Response time @ 90 % of I_{PN}	t_r	μs			3.5	@ 50 A/ μs
Frequency bandwidth (-3 dB)	BW	kHz		100		Small signals
Output RMS noise voltage spectral density (100 Hz ... 100 kHz)	e_{no}	$\mu\text{V}/\sqrt{\text{Hz}}$			6	
Output noise voltage (DC ... 10 kHz) (DC ... 100 kHz) (DC ... 1 MHz)	V_{no}	mVpp		3.6 8.7 16.9		
Primary current, detection threshold	I_{PTh}	A	$2.64 \times I_{PN}$	$2.93 \times I_{PN}$	$3.22 \times I_{PN}$	Peak value $\pm 10\%$, overcurrent detection OCD
Accuracy @ I_{PN}	X	% of I_{PN}	-1		1	
Accuracy @ I_{PN} @ $T_A = +105^\circ\text{C}$	X	% of I_{PN}	-4.55		4.55	See formula note ³⁾
Accuracy @ I_{PN} @ $T_A = +85^\circ\text{C}$	X	% of I_{PN}	-3.66		3.66	See formula note ³⁾

 Notes: ¹⁾ 3.3 V SP version available

²⁾ EEPROM in an error state makes the transducer behave like a reverse current saturation. Use of the OCD may help to differentiate the two cases.

³⁾ Accuracy @ T_A (% of I_{PN}) = $X + \left(\frac{TCG}{10000} \times (T_A - 25) + \frac{TCI_{OE}}{1000 \times I_{PN}} \times 100 \times (T_A - 25)\right)$.

Electrical data HO 150-S-0100

 At $T_A = 25\text{ °C}$, $U_C = +5\text{ V}$, $R_L = 10\text{ k}\Omega$ unless otherwise noted (see Min, Max, typ. definition paragraph in page 13).

Parameter	Symbol	Unit	Min	Typ	Max	Comment
Primary nominal RMS current	I_{PN}	A		150		
Primary current, measuring range	I_{PM}	A	-375		375	@ $U_C \geq 4.6\text{ V}$
Number of primary turns	N_P	-		1		See application information
Supply voltage ¹⁾	U_C	V	4.5	5	5.5	
Current consumption	I_C	mA		19	25	
Reference voltage (output)	V_{ref}	V	2.48	2.5	2.52	Internal reference
Reference voltage (input)	V_{ref}	V	0.5		2.65	External reference
Output voltage range @ I_{PM}	$V_{out} - V_{ref}$	V	-2		2	Over operating temperature range
V_{ref} output resistance	R_{ref}	Ω	130	200	300	Series
V_{out} output resistance	R_{out}	Ω		2	5	Series
Allowed capacitive load	C_L	nF	0		6	
Overcurrent detection output on resistance	R_{on}	Ω	70	95	150	Open drain, active low Over operating temperature range
Overcurrent detection hold	t_{hold}	ms	0.7	1	1.4	Additional time after threshold has released
EEPROM control	V_{out}	mV	0		50	V_{out} forced to GND when EEPROM in an error state ²⁾
Electrical offset voltage @ $I_p = 0\text{ A}$	V_{OE}	mV	-5		5	$V_{out} - V_{ref}$ @ $V_{ref} = 2.5\text{ V}$
Electrical offset current referred to primary	I_{OE}	A	-0.94		0.94	
Temperature coefficient of V_{ref}	TCV_{ref}	ppm/K	-170		170	-40 °C ... 105 °C
Temperature coefficient of V_{OE}	TCV_{OE}	mV/K	-0.075		0.075	-40 °C ... 105 °C
Offset drift referred to primary @ $I_p = 0\text{ A}$	TCI_{OE}	mA/K	-14.1		14.1	-40 °C ... 105 °C
Theoretical sensitivity	G_{th}	mV/A		5.333		800 mV @ I_{PN}
Sensitivity error @ I_{PN}	ϵ_G	%	-0.5		0.5	Factory adjustment (straight bus-bar)
Temperature coefficient of G	TCG	ppm/K	-350		350	-40 °C ... 105 °C
Linearity error 0 ... I_{PN}	ϵ_L	% of I_{PN}	-0.5		0.5	
Linearity error 0 ... I_{PM}	ϵ_L	% of I_{PM}	-0.5		0.5	
Magnetic offset current (@ $10 \times I_{PN}$) referred to primary	I_{OM}	A	-0.92		0.92	One turn
Reaction time @ 10 % of I_{PN}	t_{ra}	μs			2.5	@ 50 A/ μs
Response time @ 90 % of I_{PN}	t_r	μs			3.5	@ 50 A/ μs
Frequency bandwidth (-3 dB)	BW	kHz		100		Small signals
Output RMS noise voltage spectral density (100 Hz ... 100 kHz)	e_{no}	$\mu\text{V}/\sqrt{\text{Hz}}$			4.5	
Output noise voltage (DC ... 10 kHz) (DC ... 100 kHz) (DC ... 1 MHz)	V_{no}	mVpp		2.9 6.2 12.3		
Primary current, detection threshold	I_{PTH}	A	$2.64 \times I_{PN}$	$2.93 \times I_{PN}$	$3.22 \times I_{PN}$	Peak value $\pm 10\%$, overcurrent detection OCD
Accuracy @ I_{PN}	X	% of I_{PN}	-1		1	
Accuracy @ I_{PN} @ $T_A = +105\text{ °C}$	X	% of I_{PN}	-4.55		4.55	See formula note ³⁾
Accuracy @ I_{PN} @ $T_A = +85\text{ °C}$	X	% of I_{PN}	-3.66		3.66	See formula note ³⁾

 Notes: ¹⁾ 3.3 V SP version available

²⁾ EEPROM in an error state makes the transducer behave like a reverse current saturation. Use of the OCD may help to differentiate the two cases

³⁾ Accuracy @ T_A (% of I_{PN}) = $X + \left(\frac{TCG}{10000} \times (T_A - 25) + \frac{TCI_{OE}}{1000 \times I_{PN}} \times 100 \times (T_A - 25)\right)$.

Electrical data HO 200-S-0100

 At $T_A = 25\text{ °C}$, $U_C = +5\text{ V}$, $R_L = 10\text{ k}\Omega$ unless otherwise noted (see Min, Max, typ. definition paragraph in page 13).

Parameter	Symbol	Unit	Min	Typ	Max	Comment
Primary nominal RMS current	I_{PN}	A		200		
Primary current, measuring range	I_{PM}	A	-500		500	@ $U_C \geq 4.6\text{ V}$
Number of primary turns	N_p	-		1		See application information
Supply voltage ¹⁾	U_C	V	4.5	5	5.5	
Current consumption	I_C	mA		19	25	
Reference voltage (output)	V_{ref}	V	2.48	2.5	2.52	Internal reference
Reference voltage (input)	V_{ref}	V	0.5		2.65	External reference
Output voltage range @ I_{PM}	$V_{out} - V_{ref}$	V	-2		2	Over operating temperature range
V_{ref} output resistance	R_{ref}	Ω	130	200	300	Series
V_{out} output resistance	R_{out}	Ω		2	5	Series
Allowed capacitive load	C_L	nF	0		6	
Overcurrent detection output on resistance	R_{on}	Ω	70	95	150	Open drain, active low Over operating temperature range
Overcurrent detection hold	t_{hold}	ms	0.7	1	1.4	Additional time after threshold has released
EEPROM control	V_{out}	mV	0		50	V_{out} forced to GND when EEPROM in an error state ²⁾
Electrical offset voltage @ $I_p = 0\text{ A}$	V_{OE}	mV	-5		5	$V_{out} - V_{ref}$ @ $V_{ref} = 2.5\text{ V}$
Electrical offset current referred to primary	I_{OE}	A	-1.25		1.25	
Temperature coefficient of V_{ref}	TCV_{ref}	ppm/K	-170		170	-40 °C ... 105 °C
Temperature coefficient of V_{OE}	TCV_{OE}	mV/K	-0.075		0.075	-40 °C ... 105 °C
Offset drift referred to primary @ $I_p = 0\text{ A}$	TCI_{OE}	mA/K	-18.75		18.75	-40 °C ... 105 °C
Theoretical sensitivity	G_{th}	mV/A		4		800 mV @ I_{PN}
Sensitivity error @ I_{PN}	ϵ_G	%	-0.5		0.5	Factory adjustment (straight bus-bar)
Temperature coefficient of G	TCG	ppm/K	-350		350	-40 °C ... 105 °C
Linearity error 0 ... I_{PN}	ϵ_L	% of I_{PN}	-0.5		0.5	
Linearity error 0 ... I_{PM}	ϵ_L	% of I_{PM}	-0.5		0.5	
Magnetic offset current (@ $10 \times I_{PN}$) referred to primary	I_{OM}	A	-0.92		0.92	One turn
Reaction time @ 10 % of I_{PN}	t_{ra}	μs			2.5	@ 50 A/ μs
Response time @ 90 % of I_{PN}	t_r	μs			3.5	@ 50 A/ μs
Frequency bandwidth (-3 dB)	BW	kHz		100		Small signals
Output RMS noise voltage spectral density (100 Hz ... 100 kHz)	e_{no}	$\mu\text{V}/\sqrt{\text{Hz}}$			3.7	
Output noise voltage (DC ... 10 kHz) (DC ... 100 kHz) (DC ... 1 MHz)	V_{no}	mVpp		2.5 5 10		
Primary current, detection threshold	I_{PTH}	A	$2.64 \times I_{PN}$	$2.93 \times I_{PN}$	$3.22 \times I_{PN}$	Peak value $\pm 10\%$, overcurrent detection OCD
Accuracy @ I_{PN}	X	% of I_{PN}	-1		1	
Accuracy @ I_{PN} @ $T_A = +105\text{ °C}$	X	% of I_{PN}	-4.55		4.55	See formula note ³⁾
Accuracy @ I_{PN} @ $T_A = +85\text{ °C}$	X	% of I_{PN}	-3.66		3.66	See formula note ³⁾

 Notes: ¹⁾ 3.3 V SP version available

²⁾ EEPROM in an error state makes the transducer behave like a reverse current saturation. Use of the OCD may help to differentiate the two cases

³⁾ Accuracy @ T_A (% of I_{PN}) = $X + \left(\frac{TCG}{10000} \times (T_A - 25) + \frac{TCI_{OE}}{1000 \times I_{PN}} \times 100 \times (T_A - 25) \right)$

Electrical data HO 240-S-0100

 At $T_A = 25\text{ °C}$, $U_C = +5\text{ V}$, $R_L = 10\text{ k}\Omega$ unless otherwise noted (see Min, Max, typ. definition paragraph in page 13).

Parameter	Symbol	Unit	Min	Typ	Max	Comment
Primary nominal RMS current	I_{PN}	A		240		
Primary current, measuring range	I_{PM}	A	-600		600	@ $U_C \geq 4.6\text{ V}$
Number of primary turns	N_P	-		1		See application information
Supply voltage ¹⁾	U_C	V	4.5	5	5.5	
Current consumption	I_C	mA		19	25	
Reference voltage (output)	V_{ref}	V	2.48	2.5	2.52	Internal reference
Reference voltage (input)	V_{ref}	V	0.5		2.65	External reference
Output voltage range @ I_{PM}	$V_{out} - V_{ref}$	V	-2		2	Over operating temperature range
V_{ref} output resistance	R_{ref}	Ω	130	200	300	Series
V_{out} output resistance	R_{out}	Ω		2	5	Series
Allowed capacitive load	C_L	nF	0		6	
Overcurrent detection output on resistance	R_{on}	Ω	70	95	150	Open drain, active low Over operating temperature range
Overcurrent detection hold	t_{hold}	ms	0.7	1	1.4	Additional time after threshold has released
EEPROM control	V_{out}	mV	0		50	V_{out} forced to GND when EEPROM in an error state ²⁾
Electrical offset voltage @ $I_P = 0\text{ A}$	V_{OE}	mV	-5		5	$V_{out} - V_{ref}$ @ $V_{ref} = 2.5\text{ V}$
Electrical offset current referred to primary	I_{OE}	A	-1.5		1.5	
Temperature coefficient of V_{ref}	TCV_{ref}	ppm/K	-170		170	-40 °C ... 105 °C
Temperature coefficient of V_{OE}	TCV_{OE}	mV/K	-0.075		0.075	-40 °C ... 105 °C
Offset drift referred to primary @ $I_P = 0\text{ A}$	TCI_{OE}	mA/K	-22.5		22.5	-40 °C ... 105 °C
Theoretical sensitivity	G_{th}	mV/A		3.333		800 mV @ I_{PN}
Sensitivity error @ I_{PN}	ϵ_G	%	-0.5		0.5	Factory adjustment (straight bus-bar)
Temperature coefficient of G	TCG	ppm/K	-350		350	-40 °C ... 105 °C
Linearity error 0 ... I_{PN}	ϵ_L	% of I_{PN}	-0.5		0.5	
Linearity error 0 ... I_{PM}	ϵ_L	% of I_{PM}	-0.5		0.5	
Magnetic offset current (@ $10 \times I_{PN}$) referred to primary	I_{OM}	A	-0.92		0.92	One turn
Reaction time @ 10 % of I_{PN}	t_{ra}	μs			2.5	@ 50 A/ μs
Response time @ 90 % of I_{PN}	t_r	μs			3.5	@ 50 A/ μs
Frequency bandwidth (-3 dB)	BW	kHz		100		Small signals
Output RMS noise voltage spectral density (100 Hz ... 100 kHz)	e_{no}	$\mu\text{V}/\sqrt{\text{Hz}}$			3.5	
Output noise voltage (DC ... 10 kHz) (DC ... 100 kHz) (DC ... 1 MHz)	V_{no}	mVpp		2.5 5 8.7		
Primary current, detection threshold	I_{PTh}	A	$2.64 \times I_{PN}$	$2.93 \times I_{PN}$	$3.22 \times I_{PN}$	Peak value $\pm 10\%$, overcurrent detection OCD
Accuracy @ I_{PN}	X	% of I_{PN}	-1		1	
Accuracy @ I_{PN} @ $T_A = +105\text{ °C}$	X	% of I_{PN}	-4.55		4.55	See formula note ³⁾
Accuracy @ I_{PN} @ $T_A = +85\text{ °C}$	X	% of I_{PN}	-3.66		3.66	See formula note ³⁾

 Notes: ¹⁾ 3.3 V SP version available

²⁾ EEPROM in an error state makes the transducer behave like a reverse current saturation. Use of the OCD may help to differentiate the two cases

³⁾ Accuracy @ T_A (% of I_{PN}) = $X + \left(\frac{TCG}{10000} \times (T_A - 25) + \frac{TCI_{OE}}{1000 \times I_{PN}} \times 100 \times (T_A - 25) \right)$.

Electrical data HO 250-S-0100

At $T_A = 25\text{ °C}$, $U_C = +5\text{ V}$, $R_L = 10\text{ k}\Omega$ unless otherwise noted (see Min, Max, typ. definition paragraph in page 13).

Parameter	Symbol	Unit	Min	Typ	Max	Comment
Primary nominal RMS current	I_{PN}	A		250		
Primary current, measuring range	I_{PM}	A	-625		625	@ $U_C \geq 4.6\text{ V}$
Number of primary turns	N_P	-		1		See application information
Supply voltage ¹⁾	U_C	V	4.5	5	5.5	
Current consumption	I_C	mA		19	25	
Reference voltage (output)	V_{ref}	V	2.48	2.5	2.52	Internal reference
Reference voltage (input)	V_{ref}	V	0.5		2.65	External reference
Output voltage range @ I_{PM}	$V_{out} - V_{ref}$	V	-2		2	Over operating temperature range
V_{ref} output resistance	R_{ref}	Ω	130	200	300	Series
V_{out} output resistance	R_{out}	Ω		2	5	Series
Allowed capacitive load	C_L	nF	0		6	
Overcurrent detection output on resistance	R_{on}	Ω	70	95	150	Open drain, active low Over operating temperature range
Overcurrent detection hold	t_{hold}	ms	0.7	1	1.4	Additional time after threshold has released
EEPROM control	V_{out}	mV	0		50	V_{out} forced to GND when EEPROM in an error state ²⁾
Electrical offset voltage @ $I_P = 0\text{ A}$	V_{OE}	mV	-5		5	$V_{out} - V_{ref}$ @ $V_{ref} = 2.5\text{ V}$
Electrical offset current referred to primary	I_{OE}	A	-1.57		1.57	
Temperature coefficient of V_{ref}	TCV_{ref}	ppm/K	-170		170	-40 °C ... 105 °C
Temperature coefficient of V_{OE}	TCV_{OE}	mV/K	-0.075		0.075	-40 °C ... 105 °C
Offset drift referred to primary @ $I_P = 0\text{ A}$	TCI_{OE}	mA/K	-23.5		23.5	-40 °C ... 105 °C
Theoretical sensitivity	G_{th}	mV/A		3.2		800 mV @ I_{PN}
Sensitivity error @ I_{PN}	ϵ_G	%	-0.5		0.5	Factory adjustment (straight bus-bar)
Temperature coefficient of G	TCG	ppm/K	-350		350	-40 °C ... 105 °C
Linearity error 0 ... I_{PN}	ϵ_L	% of I_{PN}	-0.5		0.5	
Linearity error 0 ... I_{PM}	ϵ_L	% of I_{PM}	-0.5		0.5	
Magnetic offset current (@ $10 \times I_{PN}$) referred to primary	I_{OM}	A	-0.92		0.92	One turn
Reaction time @ 10 % of I_{PN}	t_{ra}	μs			2.5	@ 50 A/ μs
Response time @ 90 % of I_{PN}	t_r	μs			3.5	@ 50 A/ μs
Frequency bandwidth (-3 dB)	BW	kHz		100		Small signals
Output RMS noise voltage spectral density (100 Hz ... 100 kHz)	e_{no}	$\mu\text{V}/\sqrt{\text{Hz}}$			3.5	
Output noise voltage (DC ... 10 kHz) (DC ... 100 kHz) (DC ... 1 MHz)	V_{no}	mVpp		2.5 5 8.7		
Primary current, detection threshold	I_{PTh}	A	$2.64 \times I_{PN}$	$2.93 \times I_{PN}$	$3.22 \times I_{PN}$	Peak value $\pm 10\%$, overcurrent detection OCD
Accuracy @ I_{PN}	X	% of I_{PN}	-1		1	
Accuracy @ I_{PN} @ $T_A = +105\text{ °C}$	X	% of I_{PN}	-4.55		4.55	See formula note ³⁾
Accuracy @ I_{PN} @ $T_A = +85\text{ °C}$	X	% of I_{PN}	-3.66		3.66	See formula note ³⁾

Notes: ¹⁾ 3.3 V SP version available

²⁾ EEPROM in an error state makes the transducer behave like a reverse current saturation. Use of the OCD may help to differentiate the two cases

³⁾ Accuracy @ T_A (% of I_{PN}) = $X + \left(\frac{TCG}{10000} \times (T_A - 25) + \frac{TCI_{OE}}{1000 \times I_{PN}} \times 100 \times (T_A - 25) \right)$.

HO-S series, measuring range versus external reference voltage

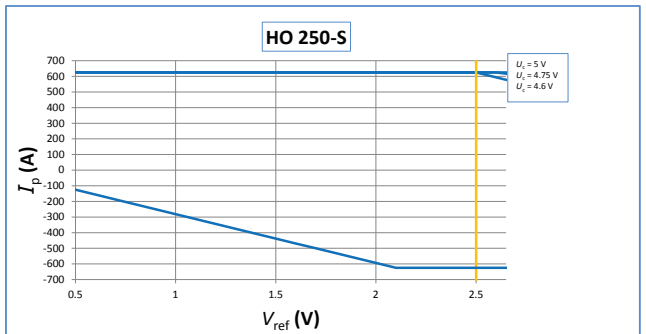
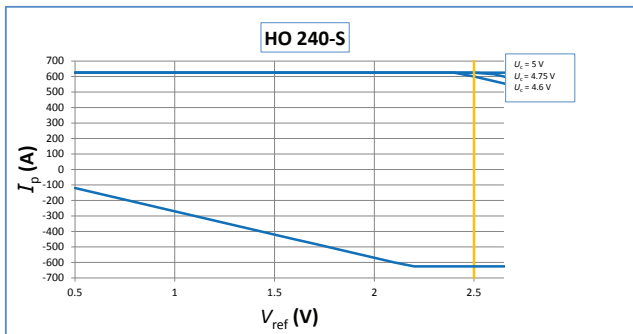
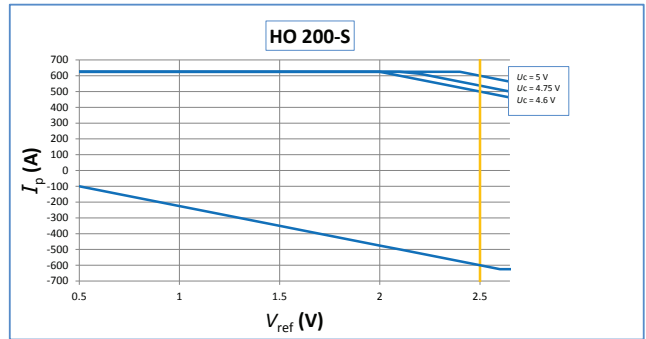
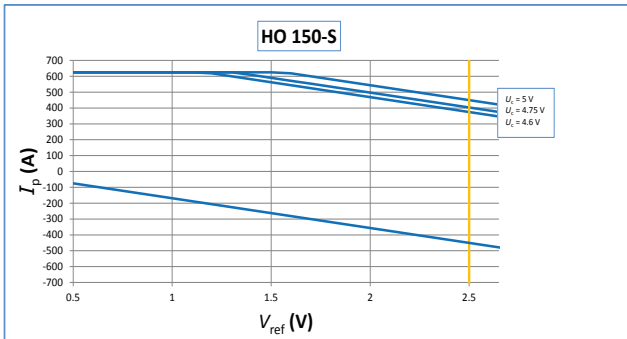
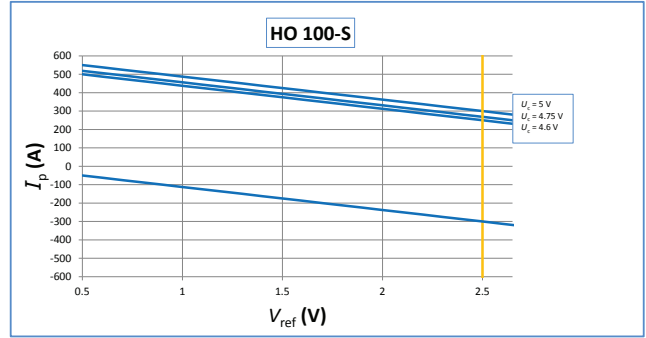
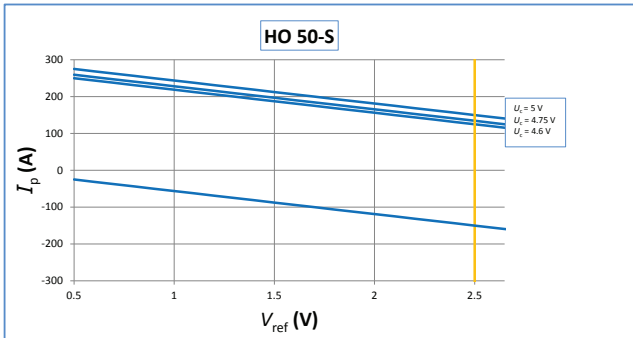

Maximum continuous DC current

For all ranges:

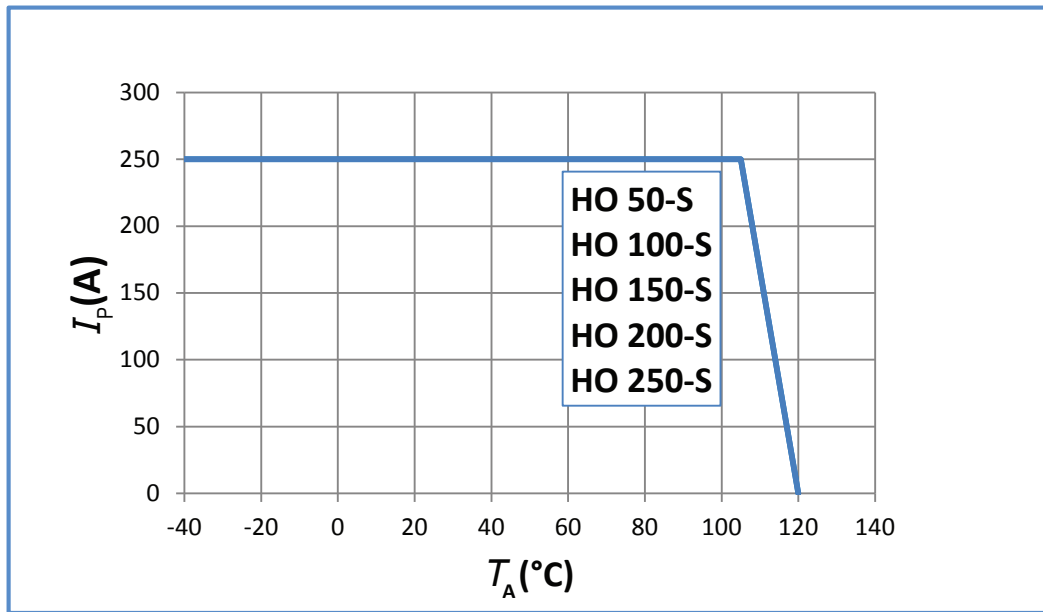

Important notice: whatever the usage and/or application, the transducer primary bar temperature shall not go above the maximum rating of 120 °C as stated in page 2 of this datasheet.

Frequency derating versus primary current and core temperature increase ΔT (°C)

Primary current in A RMS is sine wave.

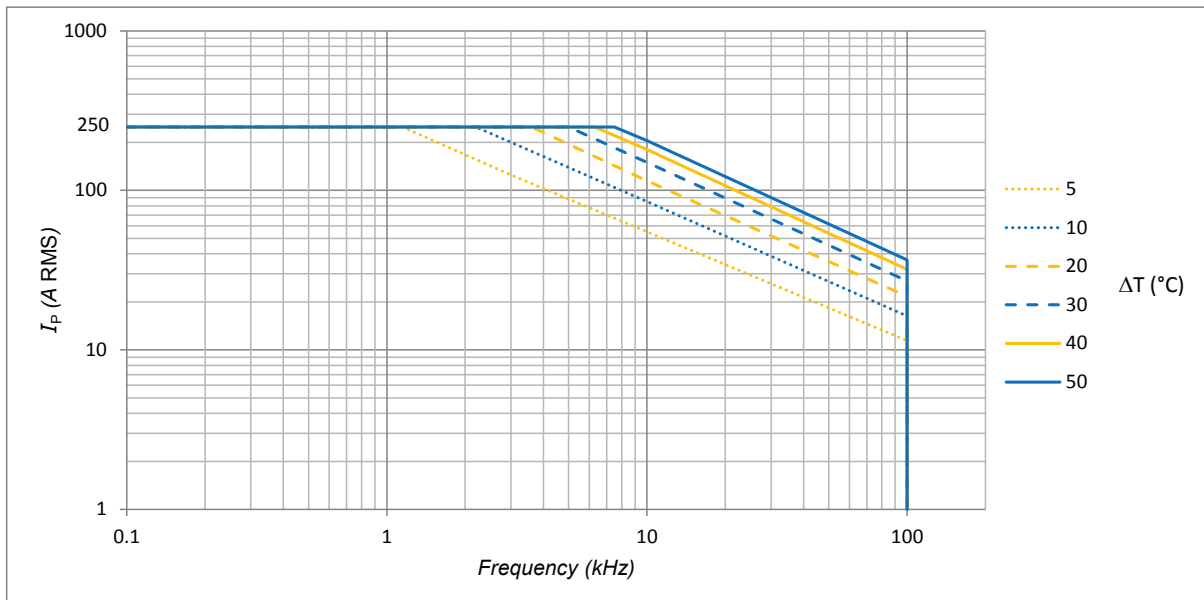

Example:

Primary current ripple (sine wave): 50 A RMS

Ripple frequency: 20 kHz

- the core temperature increase is 10 °C

HO-S series: name and codification

HO family products may be ordered **on request** ¹⁾ with a dedicated setting of the parameters as described below (standard products are delivered with the setting 0100 according to the table).

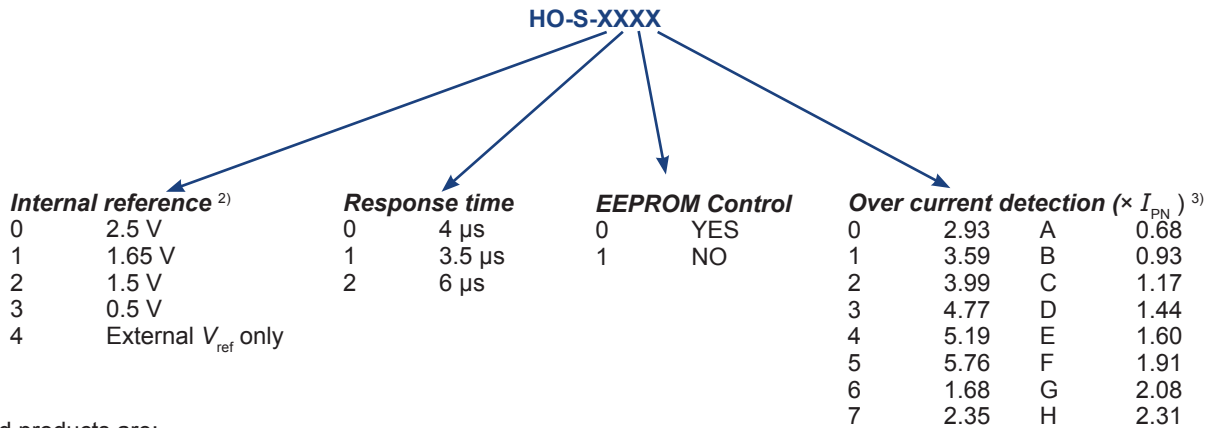

Standard products are:

- HO 50-S-0100
- HO 100-S-0100
- HO 150-S-0100
- HO 200-S-0100
- HO 240-S-0100
- HO 250-S-0100

Notes: ¹⁾ For dedicated settings, minimum quantities apply, please contact your local LEM support.

²⁾ V_{ref} electrical data

V_{ref} parameter	V_{ref} (V)			TCV_{ref} (ppm/K)	
	min	typ	max	min	max
0	2.48	2.5	2.52	-170	-70
1	1.63	1.65	1.67	-170	170
2	1.48	1.5	1.52	-170	170
3	0.49	0.5	0.51	-250	250

³⁾ OCD ($\times I_{PN}$) correction table versus range and temperature

All other values or empty cells: no change

HO-S-010x				
OCD Parameter	I_{PN} (A) all temperatures			
	150	200	240	250
A				
B				
C				
D				
E				
6				
F				
G				
H				
7				
0				
1				
2				
3			510	5.60
4			6.70	7.30
5		6.25		-

Tolerance on OCD value	
$\pm 20\%$	
$\pm 15\%$	
$\pm 10\%$	No change
-	Do not use

Application information

- HOxx-S series is designed to be used with a bus-bar or a cable ¹⁾ to carry the current through the aperture with a maximum cross-section of 8 × 15 mm
- Use of a bare conductor is not recommended with panel mounting (either horizontal or vertical) as insulation distances might be compromised between the busbar and fixation screws.

Insulation distance (nominal values):

	d_{Cp}	d_{Cl}
Between primary busbar and secondary pin	14.6 mm	-
Between primary busbar and core	-	11.34 mm
Between core and secondary terminal	-	1.18 mm

Note: ¹⁾ The maximum magnetic offset referred to primary is inversely proportional to the number of turns, thus is divided by 2 with 2 turns

Definition of typical, minimum and maximum values

Minimum and maximum values for specified limiting and safety conditions have to be understood as such as well as values shown in “typical” graphs.

On the other hand, measured values are part of a statistical distribution that can be specified by an interval with upper and lower limits and a probability for measured values to lie within this interval.

Unless otherwise stated (e.g. “100 % tested”), the LEM definition for such intervals designated with “min” and “max” is that the probability for values of samples to lie in this interval is 99.73 %.

For a normal (Gaussian) distribution, this corresponds to an interval between -3 sigma and $+3$ sigma. If “typical” values are not obviously mean or average values, those values are defined to delimit intervals with a probability of 68.27 %, corresponding to an interval between $-\sigma$ and $+\sigma$ for a normal distribution.

Typical, maximal and minimal values are determined during the initial characterization of the product.

Remark

Installation of the transducer must be done unless otherwise specified on the datasheet, according to LEM Transducer Generic Mounting Rules. Please refer to LEM document N°ANE120504 available on our Web site: [Products/Product Documentation](#)

Safety

This transducer must be used in limited-energy secondary circuits.



This transducer must be used in electric/electronic equipment with respect to applicable standards and safety requirements in accordance with the manufacturer’s operating instructions.



Caution, risk of electrical shock.

When operating the transducer, certain parts of the module can carry hazardous voltage (e.g. primary bus bar, power supply). Ignoring this warning can lead to injury and/or cause serious damage.

This transducer is a build-in device, whose conducting parts must be inaccessible after installation.

A protective housing or additional shield could be used.

Main supply must be able to be disconnected.

Dimensions HO-S series (mm, general linear tolerance ± 0.3 mm)

Mounting example: horizontal

Technical drawing showing dimensions and connection details for the HO 50 ... 250-S series transducer. The drawing includes a top view, a side view, and a perspective view. Dimensions are provided in millimeters. Key features include a numbering pin, a marking area, and a hall element position. The drawing also shows the transducer being inserted into a mounting foot, with a 'CLICK' sound indicated.

Dimension busbar 15mm x 8mm

Numbering pin

2 \times 0.1 (x4)

5

33.12

9.6

2.3

4.7

18.8

15.97

8.2

8.67

Hall element position

MARKING AREA

1 2 3 4 5

Numbering pin

29.8

10.5

9.5

11.8

5.5

37.8

45.07

Tightening torque- 1 N.m (Screw + washer)

40.8

31.4

13.4

16.2

ϕ 6.3 (x2)

16.96

Connection

5

4

3

2

1

OCD

U_R

V_{ref} (IN/OUT)

V_{out}

GND - or 0V

I_p

C_1

C_2

C_3

U_C

C1	47 nF
C2	4.7 nF
C3	47 nF

CLICK

Remarks:

- V_{OUT} is positive with respect to V_{ref} when positive I_p flows in direction of the arrow shown on the drawing above.
- Connection system: equivalent to JST B5B-PH type
- Mounting foot may be removed and repositioned as shown on pages 14,15 and 16 of this datasheet. We recommend to change the mounting foot position just once.

Dimensions HO-S series (mm, general linear tolerance ± 0.3 mm)

Mounting example: vertical

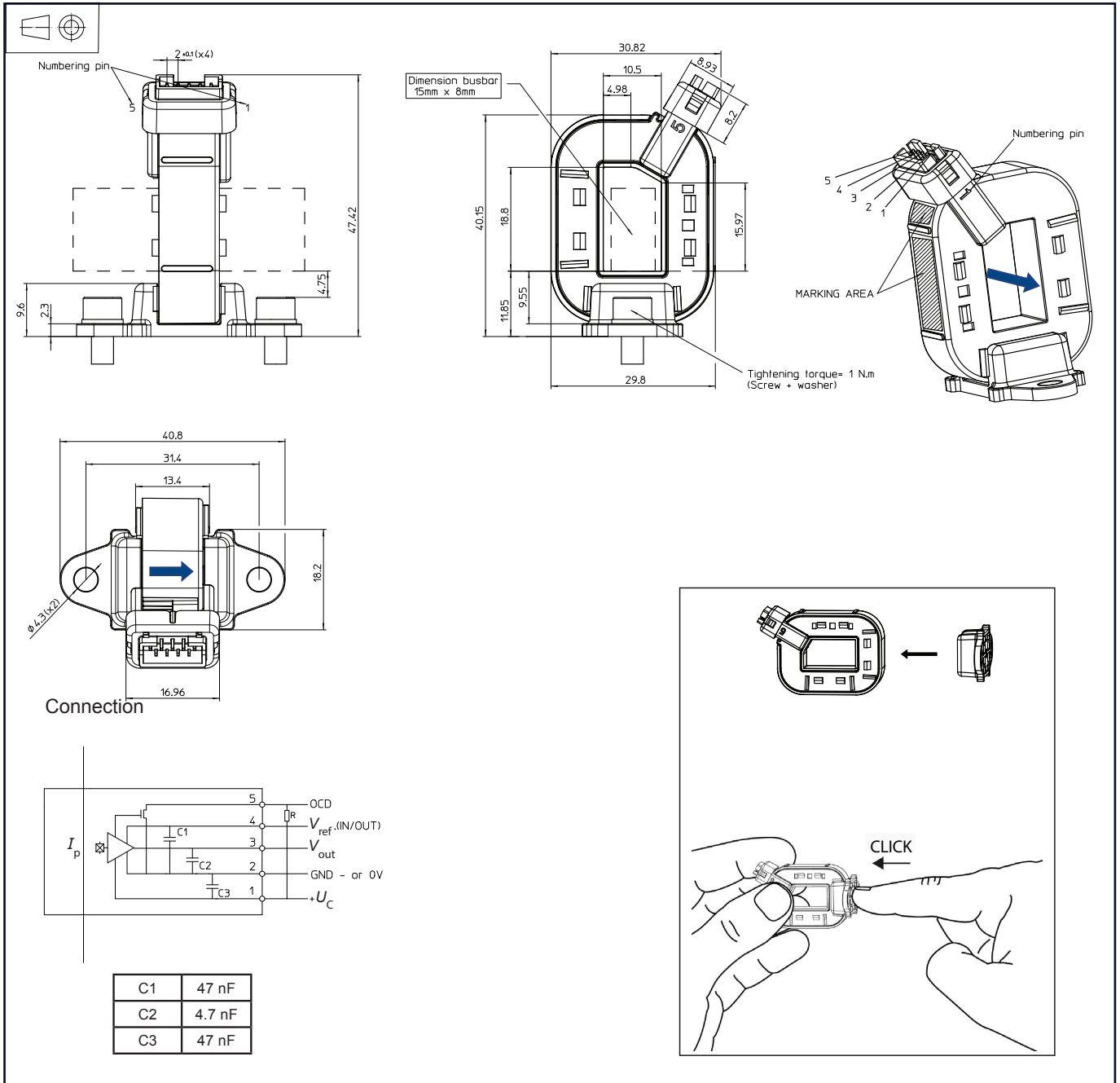

Remarks:

- V_{OUT} is positive with respect to V_{ref} when positive I_p flows in direction of the arrow shown on the drawing above.
- Connection system: equivalent to JST B5B-PH type
- Mounting foot may be removed and repositioned as shown on pages 14,15 and 16 of this datasheet. We recommend to change the mounting foot position just once.

Dimensions HO-S series (mm, general linear tolerance ± 0.3 mm)

Mounting example: busbar

Numbering pin

2 \times 0.1 (x4)

14.71

30.8

Dimension busbar 15mm x 8mm

Tightening torque= 1 Nm (Screw + washer)

8.2

8.33

Hall element position

4.98

8.2

29.8

9.6

18.8

37.8

MARKING AREA

Numbering pin

40.8

31.4

13.4

16.2

16.96

Connection

5

4

3

2

1

OCD

V_{ref} (IN/OUT)

V_{out}

GND - or 0V

$-U_C$

I_p

C1

C2

C3

C1	47 nF
C2	4.7 nF
C3	47 nF

CLICK

Remarks:

- V_{OUT} is positive with respect to V_{ref} when positive I_p flows in direction of the arrow shown on the drawing above.
- Connection system: equivalent to JST B5B-PH type
- Mounting foot may be removed and repositioned as shown on pages 14,15 and 16 of this datasheet. We recommend to change the mounting foot position just once.