

IRG4BC30S-S

INSULATED GATE BIPOLAR TRANSISTOR

Standard Speed IGBT

Features

- Standard: optimized for minimum saturation voltage and low operating frequencies (< 1kHz)
- Generation 4 IGBT design provides tight parameter distribution and high efficiency

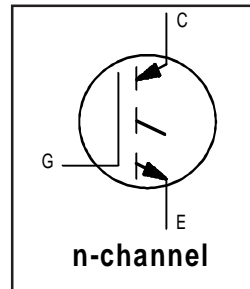

$V_{CES} = 600V$
$V_{CE(on)} \text{ typ.} = 1.4V$
@ $V_{GE} = 15V, I_C = 18A$

Benefits

- Generation 4 IGBTs offer highest efficiency available
- IGBTs optimized for specified application conditions

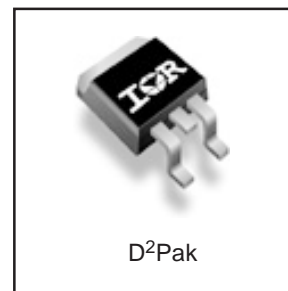

Absolute Maximum Ratings

	Parameter	Max.	Units
V_{CES}	Collector-to-Emitter Breakdown Voltage	600	V
$I_C @ T_C = 25^\circ C$	Continuous Collector Current	34	A
$I_C @ T_C = 100^\circ C$	Continuous Collector Current	18	
I_{CM}	Pulsed Collector Current ①	68	
I_{LM}	Clamped Inductive Load Current ②	68	
V_{GE}	Gate-to-Emitter Voltage	± 20	V
E_{ARV}	Reverse Voltage Avalanche Energy ③	10	mJ
$P_D @ T_C = 25^\circ C$	Maximum Power Dissipation	100	W
$P_D @ T_C = 100^\circ C$	Maximum Power Dissipation	42	
T_J	Operating Junction and	-55 to +150	°C
T_{STG}	Storage Temperature Range		
	Soldering Temperature, for 10 seconds	300 (0.063 in. (1.6mm) from case)	

Thermal Resistance

	Parameter	Typ.	Max.	Units
$R_{\theta JC}$	Junction-to-Case	—	1.2	°C/W
$R_{\theta CS}$	Case-to-Sink, Flat, Greased Surface	0.50	—	
$R_{\theta JA}$	Junction-to-Ambient, typical socket mount	—	40	
Wt	Weight	1.44	—	g (oz)

IRG4BC30S-S

Electrical Characteristics @ $T_J = 25^\circ\text{C}$ (unless otherwise specified)

	Parameter	Min.	Typ.	Max.	Units	Conditions
$V_{(BR)CES}$	Collector-to-Emitter Breakdown Voltage	600	—	—	V	$V_{GE} = 0V, I_C = 250\mu A$
$V_{(BR)ECS}$	Emitter-to-Collector Breakdown Voltage ^④	18	—	—	V	$V_{GE} = 0V, I_C = 1.0A$
$\Delta V_{(BR)CES}/\Delta T_J$	Temperature Coeff. of Breakdown Voltage	—	0.75	—	V/ $^\circ\text{C}$	$V_{GE} = 0V, I_C = 1.0mA$
$V_{CE(ON)}$	Collector-to-Emitter Saturation Voltage	—	1.40	1.6	V	$I_C = 18A$ $V_{GE} = 15V$ See Fig. 2, 5
		—	1.84	—		
		—	1.45	—		
$V_{GE(th)}$	Gate Threshold Voltage	3.0	—	6.0		$I_C = 18A, T_J = 150^\circ\text{C}$ $V_{CE} = V_{GE}, I_C = 250\mu A$
$\Delta V_{GE(th)}/\Delta T_J$	Temperature Coeff. of Threshold Voltage	—	-11	—	mV/ $^\circ\text{C}$	$V_{CE} = V_{GE}, I_C = 250\mu A$
g_{fe}	Forward Transconductance ^⑤	6.0	11	—	S	$V_{CE} = 100V, I_C = 18A$
I_{CES}	Zero Gate Voltage Collector Current	—	—	250	μA	$V_{GE} = 0V, V_{CE} = 600V$ $V_{GE} = 0V, V_{CE} = 10V, T_J = 25^\circ\text{C}$ $V_{GE} = 0V, V_{CE} = 600V, T_J = 150^\circ\text{C}$
		—	—	2.0		
		—	—	1000		
I_{GES}	Gate-to-Emitter Leakage Current	—	—	± 100	nA	$V_{GE} = \pm 20V$

Switching Characteristics @ $T_J = 25^\circ\text{C}$ (unless otherwise specified)

	Parameter	Min.	Typ.	Max.	Units	Conditions
Q_g	Total Gate Charge (turn-on)	—	50	75	nC	$I_C = 18A$ $V_{CC} = 400V$ $V_{GE} = 15V$ See Fig. 8
Q_{ge}	Gate - Emitter Charge (turn-on)	—	7.3	11		
Q_{gc}	Gate - Collector Charge (turn-on)	—	17	26		
$t_{d(on)}$	Turn-On Delay Time	—	22	—	ns	$T_J = 25^\circ\text{C}$ $I_C = 18A, V_{CC} = 480V$ $V_{GE} = 15V, R_G = 23\Omega$ Energy losses include "tail" See Fig. 9, 10, 14
t_r	Rise Time	—	18	—		
$t_{d(off)}$	Turn-Off Delay Time	—	540	810		
t_f	Fall Time	—	390	590		
E_{on}	Turn-On Switching Loss	—	0.26	—	mJ	See Fig. 9, 10, 14
E_{off}	Turn-Off Switching Loss	—	3.45	—		
E_{ts}	Total Switching Loss	—	3.71	5.6		
$t_{d(on)}$	Turn-On Delay Time	—	21	—	ns	$T_J = 150^\circ\text{C}$, $I_C = 18A, V_{CC} = 480V$ $V_{GE} = 15V, R_G = 23\Omega$ Energy losses include "tail" See Fig. 11, 14
t_r	Rise Time	—	19	—		
$t_{d(off)}$	Turn-Off Delay Time	—	790	—		
t_f	Fall Time	—	760	—		
E_{ts}	Total Switching Loss	—	6.55	—	mJ	See Fig. 11, 14
L_E	Internal Emitter Inductance	—	7.5	—	nH	Measured 5mm from package
C_{ies}	Input Capacitance	—	1100	—	pF	$V_{GE} = 0V$ $V_{CC} = 30V$ $f = 1.0MHz$ See Fig. 7
C_{oes}	Output Capacitance	—	72	—		
C_{res}	Reverse Transfer Capacitance	—	13	—		

Notes:

- ① Repetitive rating; $V_{GE} = 20V$, pulse width limited by max. junction temperature (See fig. 13b).
- ② $V_{CC} = 80\%(V_{CES}), V_{GE} = 20V, L = 10\mu H, R_G = 23\Omega$, (See fig. 13a).
- ③ Repetitive rating; pulse width limited by maximum junction temperature.
- ④ Pulse width $\leq 80\mu s$; duty factor $\leq 0.1\%$.
- ⑤ Pulse width $5.0\mu s$, single shot.

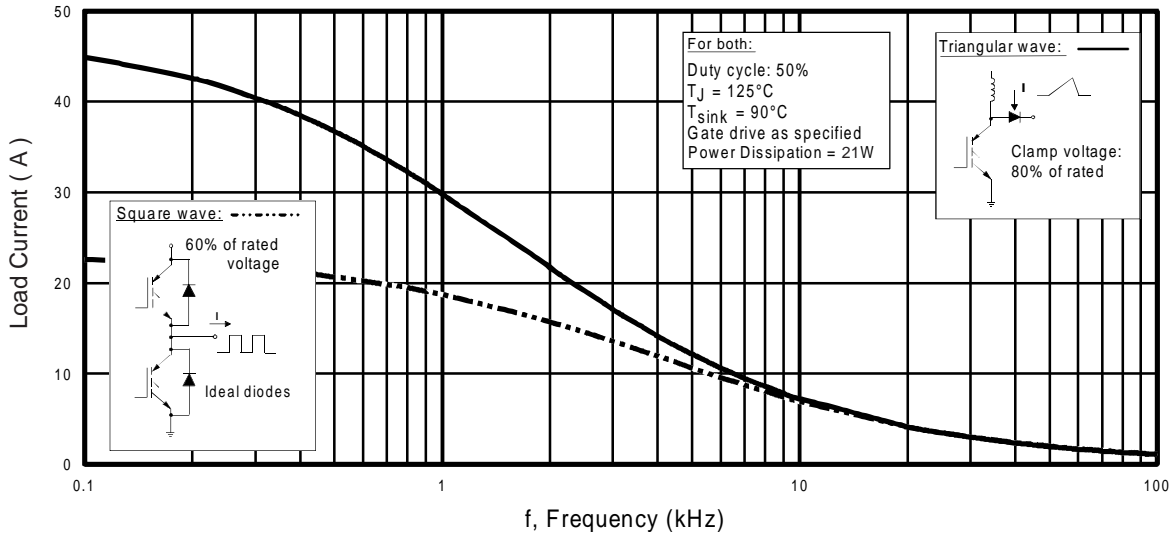

Fig. 1 - Typical Load Current vs. Frequency
 (Load Current = I_{RMS} of fundamental)

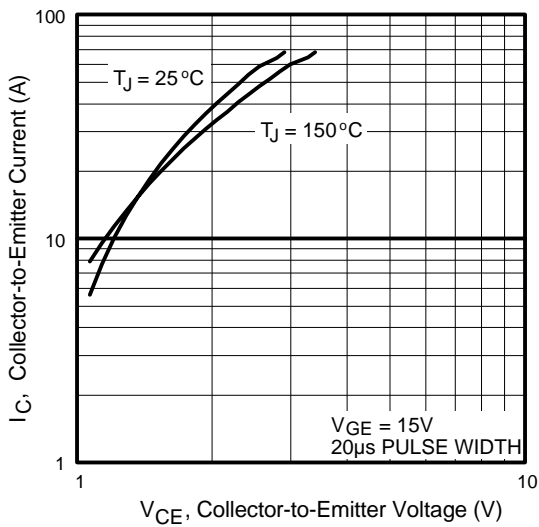

Fig. 2 - Typical Output Characteristics

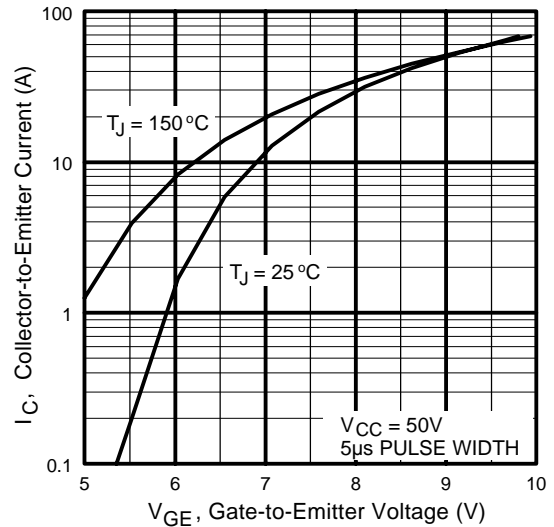

Fig. 3 - Typical Transfer Characteristics

IRG4BC30S-S

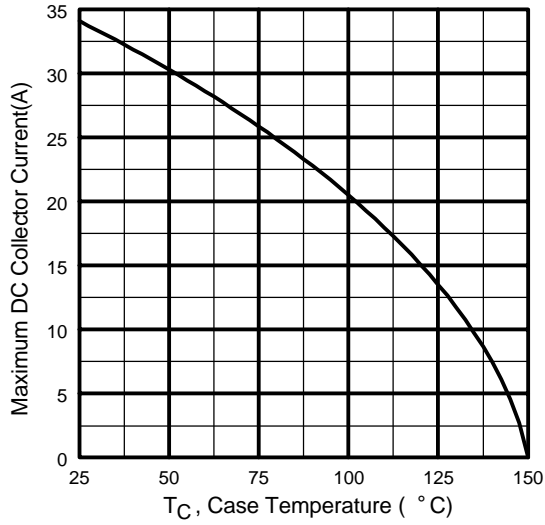

Fig. 4 - Maximum Collector Current vs. Case Temperature

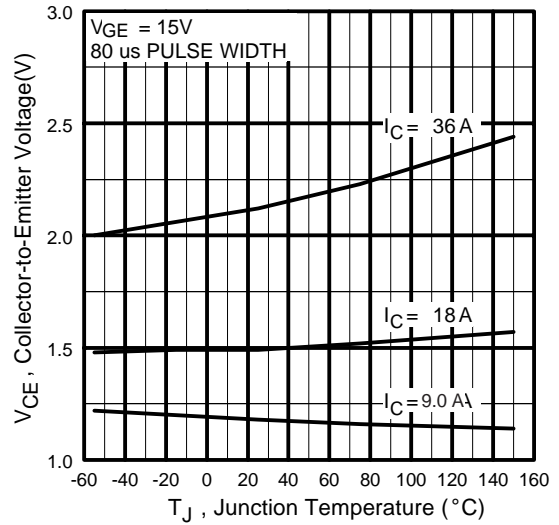

Fig. 5 - Typical Collector-to-Emitter Voltage vs. Junction Temperature

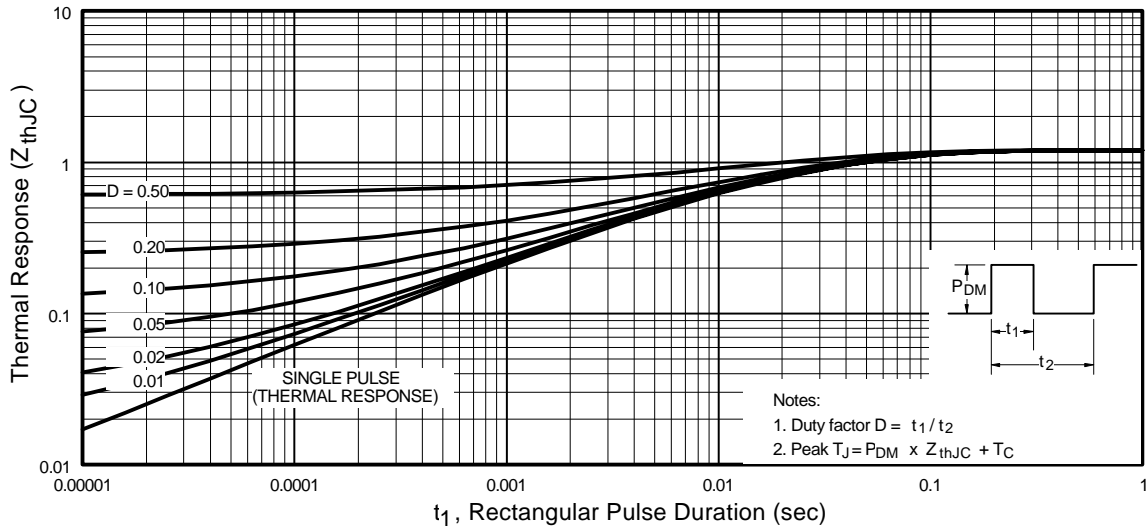

Fig. 6 - Maximum Effective Transient Thermal Impedance, Junction-to-Case

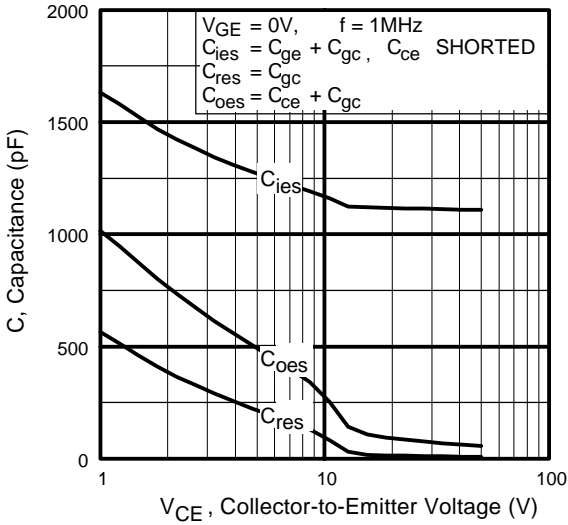

Fig. 7 - Typical Capacitance vs. Collector-to-Emitter Voltage

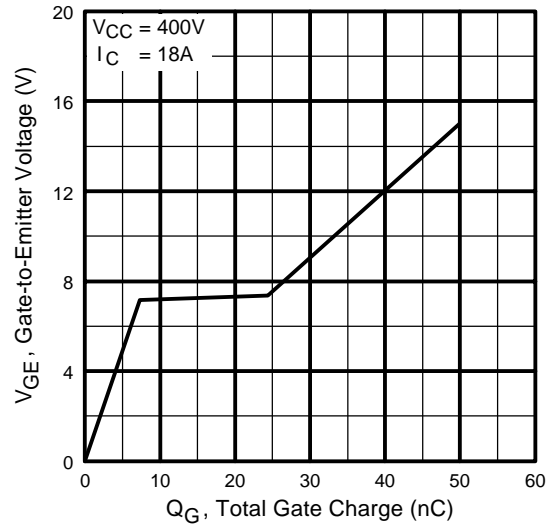

Fig. 8 - Typical Gate Charge vs. Gate-to-Emitter Voltage

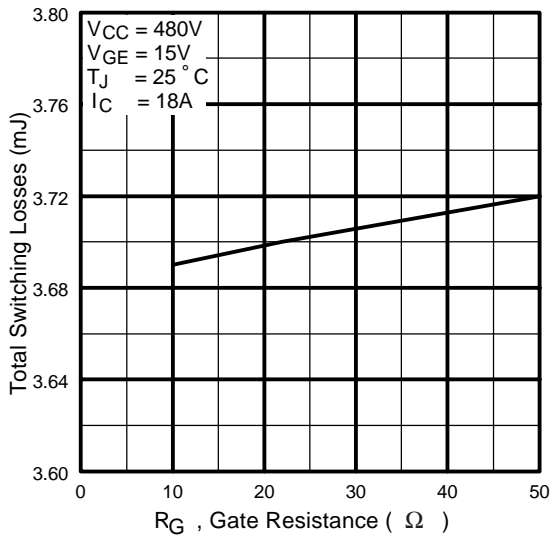

Fig. 9 - Typical Switching Losses vs. Gate Resistance

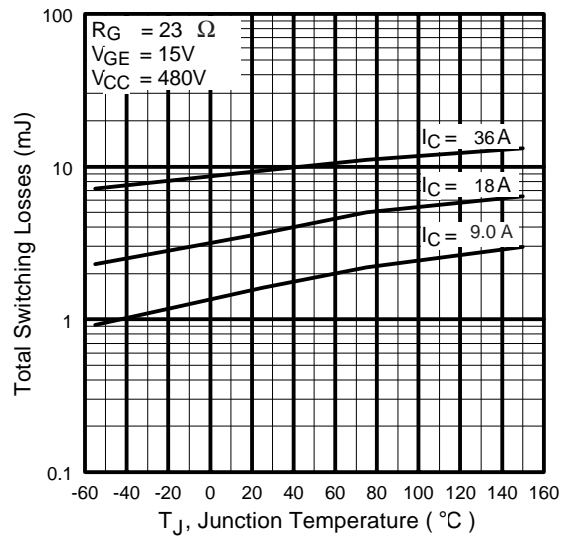

Fig. 10 - Typical Switching Losses vs. Junction Temperature

IRG4BC30S-S

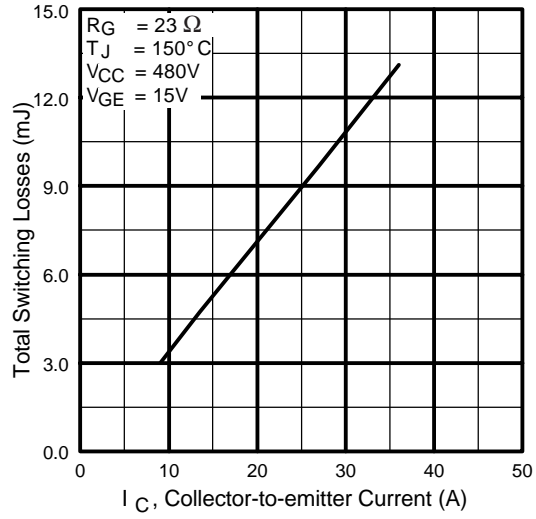

Fig. 11 - Typical Switching Losses vs. Collector-to-Emitter Current

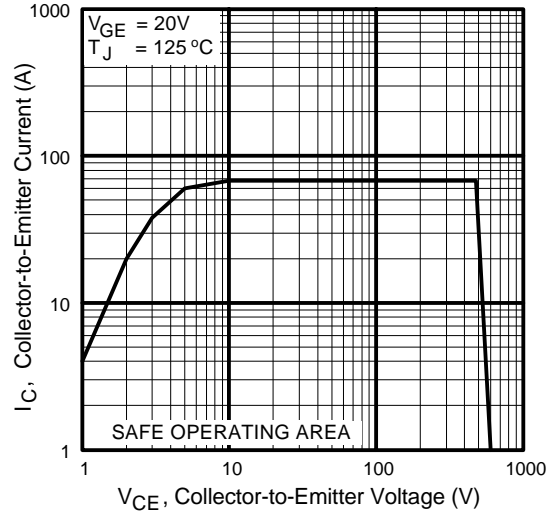

Fig. 12 - Turn-Off SOA

IRG4BC30S-S

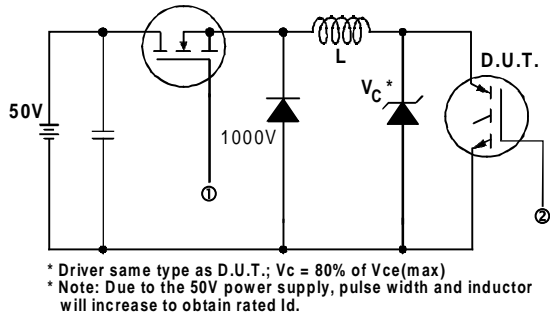

Fig. 13a - Clamped Inductive Load Test Circuit

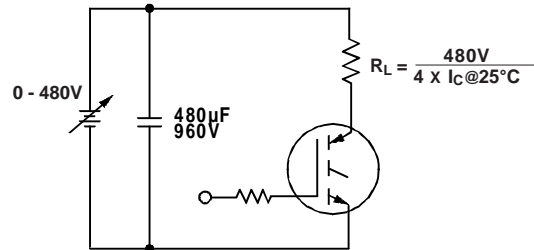

Fig. 13b - Pulsed Collector Current Test Circuit

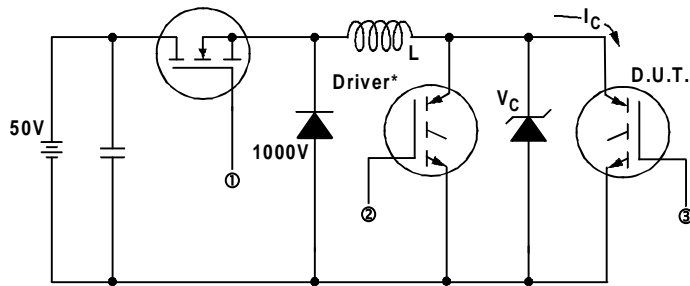

Fig. 14a - Switching Loss Test Circuit

* Driver same type as D.U.T., $V_c = 480V$

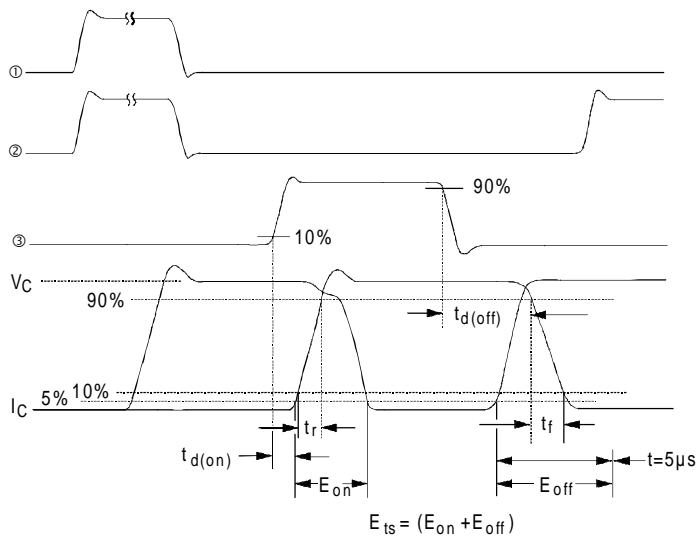
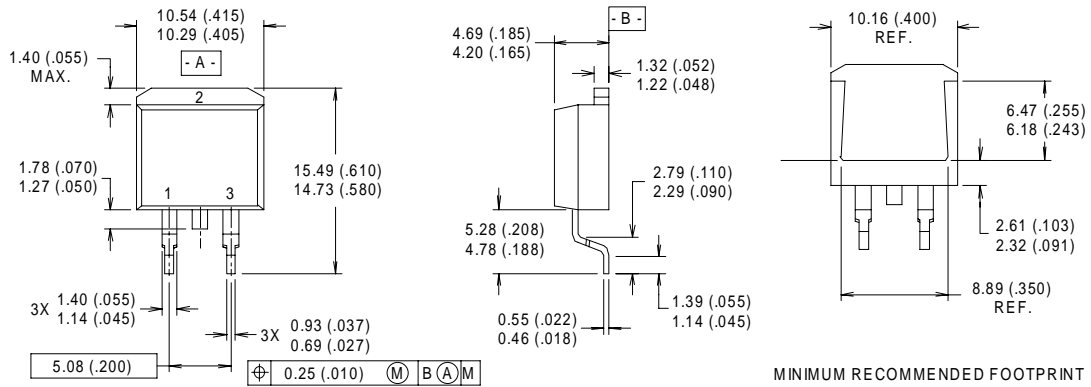

Fig. 14b - Switching Loss Waveforms

IRG4BC30S-S

D²Pak Package Outline



NOTES:

- 1 DIMENSIONS AFTER SOLDER DIP.
- 2 DIMENSIONING & TOLERANCING PER ANSI Y14.5M, 1982.
- 3 CONTROLLING DIMENSION : INCH.
- 4 HEATSINK & LEAD DIMENSIONS DO NOT INCLUDE BURRS.

LEAD ASSIGNMENTS

- 1 - GATE
- 2 - DRAIN
- 3 - SOURCE

D²Pak Part Marking Information

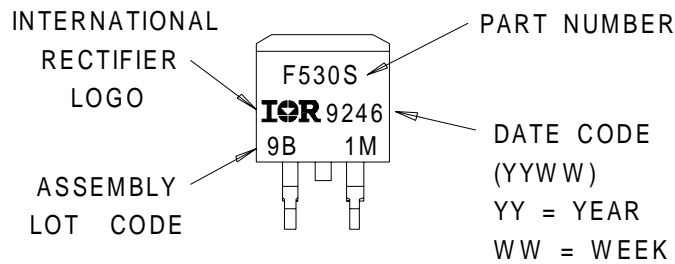

D²Pak Tape & Reel Information

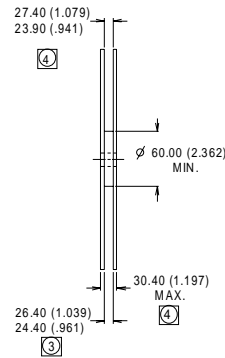
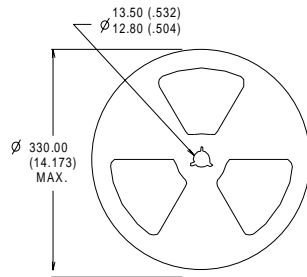
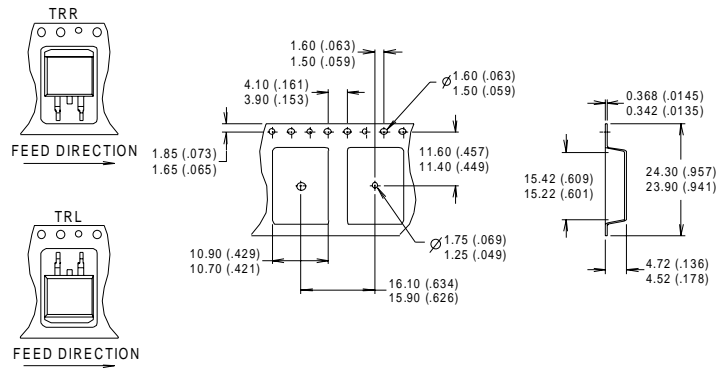

- NOTES:
1. CONFORMS TO EIA-418.
 2. CONTROLLING DIMENSION: MILLIMETER.
 3. DIMENSION MEASURED @ HUB.
 4. INCLUDES FLANGE DISTORTION @ OUTER EDGE.

Data and specifications subject to change without notice.
 This product has been designed and qualified for the industrial market.
 Qualification Standards can be found on IR's Web site.

Note: For the most current drawings please refer to the IR website at:
<http://www.irf.com/package/>